

CRESSI
SINCE 1946

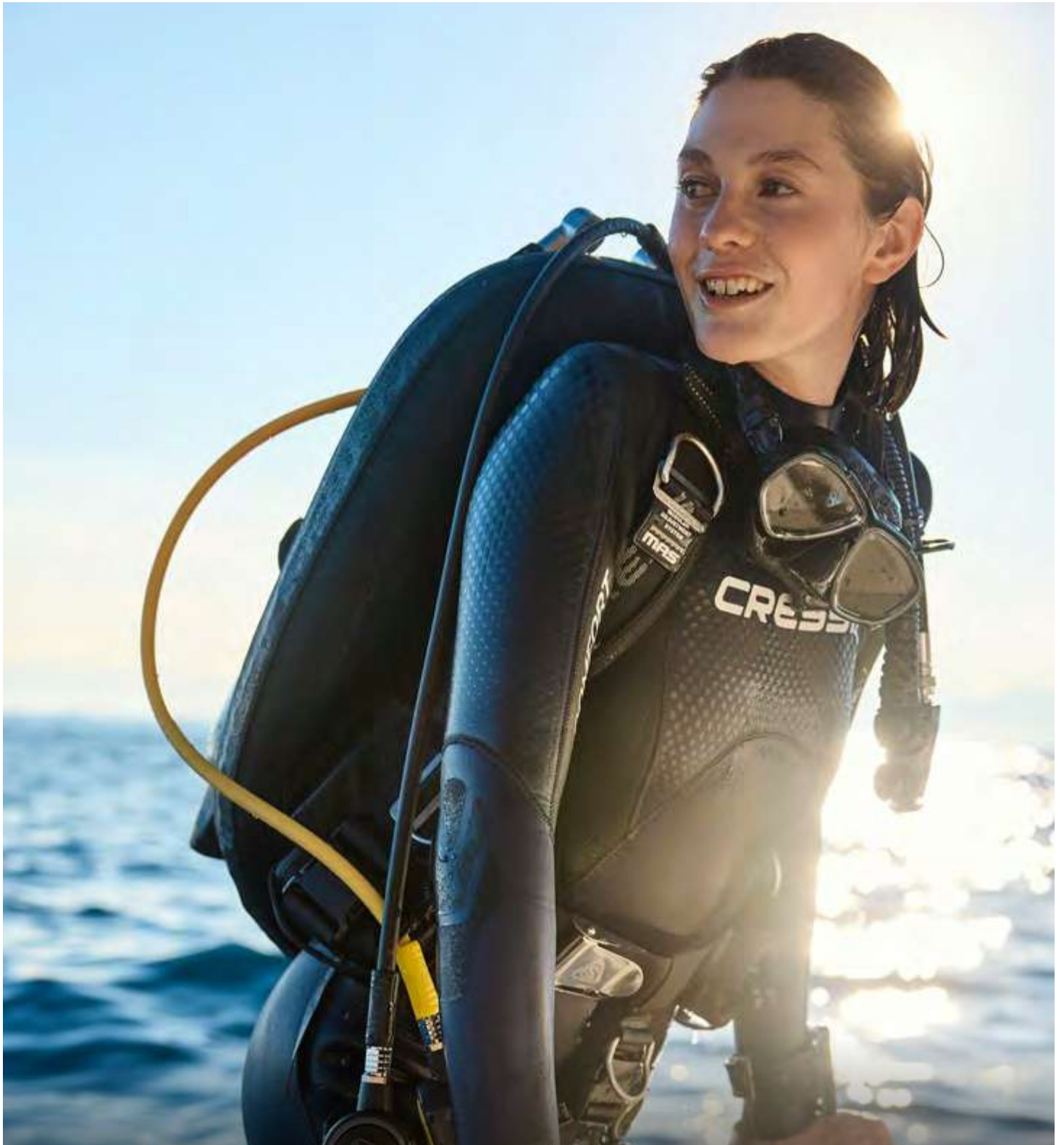

COLLECTION
BUYER'S GUIDE 2025

SCUBA DIVING | FREEDIVING | SNORKELING | SWIMMING | WATERSPORTS | SPEARFISHING

RRP €

CRESSI

ICONIC DIVE GEAR SINCE 1946

Thank you for your support to:

**Cressi Global Team
Our Photographers
Our Partners
Our Ambassadors**

Special thanks to:

**Our Collaborators
Bagni Medusa, Genova**

CRESSI

CARES

Cressi was founded, and still lives, just steps from the sea in **Genoa**. We breathe sea air in everything we do, and every one of our products is inspired by the incredible beauty of the waters we see before us.

The only way to fight pollution in the sea is to be aware and active, first hand.

Cressi decided to take some concrete actions



CRESSI'S PACKAGING



We live by the sea, we work with the sea and we love the sea, so it's our responsibility to give it care and respect. Our goal is to replace all plastic packaging with alternative sustainable solutions following our policy.

CRESSI

“ In Cressi we have always focused on sustainability by orienting ourselves to the protection of the environment and especially of our seas. We follow the sustainable direction on many fronts, such as in the choice of packaging materials, where we are reducing plastic and replacing it with recycled or recyclable materials. We are also very active in sponsoring events related to cleaning up the seas to ensure that future generations have our same opportunities.”

Marco Cressi

BUYER'S GUIDE

NEW COLLECTION

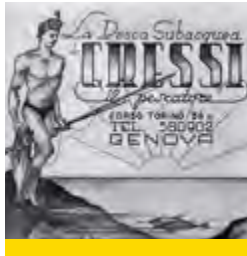

CRESSI
WHO WE ARE

8

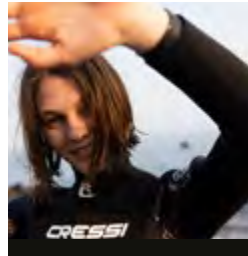

BUYER'S GUIDE
OUR DNA

16



COMPUTERS
DIVING DEVICES

28



COMPUTER WATCHES
DIVING COMPACT DEVICES

40



DRYSUITS & WETSUITS
FOR DIVING

130

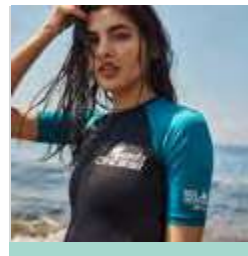

SHORTY WETSUITS
FOR SURFACE

154

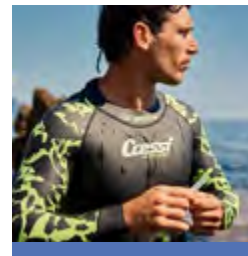

SWIMMING WETSUITS
FOR SWIMMING

166



WATERSPORT
NEOPRENE
FOR WATER ACTIVITIES

174



SNORKEL SETS
FINS + MASK + SNORKEL

254



MASKS
DESIGNED FOR BEST VISIBILITY

260



SNORKELING MASKS
QUALITY AND AFFORDABLE MASKS

295



FULL FACE MASKS
SNORKELING MASKS

314

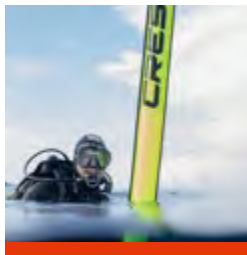

BUOYS, BALLOON & TANKS
FOR DIVING, SWIMMING AND FREEDIVING

420

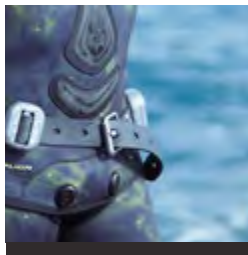

BELTS
FOR WEIGHTS FASTENING

426



FOOTWEAR
ADULTS & KIDS

428



SUNGLASSES
FOR YOUR SUMMER ACTIVITIES

464



CONSOLES
DIVING PRECISE INSTRUMENTS

52



REGULATORS
HIGH PERFORMANCE STAGES

61



B.C.D.'S
BUOYANCY CONTROL DEVICES

86

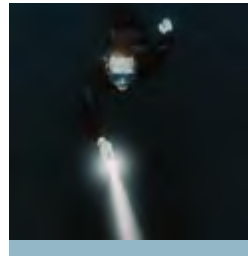

DIVE TORCHES
HIGH PERFORMANCE LED LIGHT

114



KNIVES
RELIABLE MARINE BLADES

118



AFTER DIVE
ACCESSORIES

176

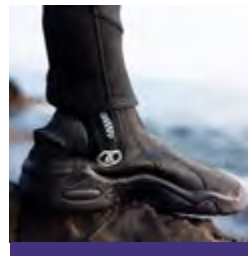

NEOPRENE
ACCESSORIES

182

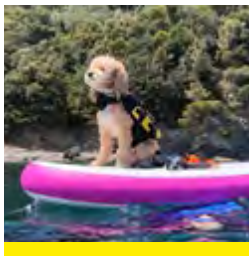

CRESSI DOG
BRINGS YOUR DOG IN WATER

198



RASHGUARDS
TECHNICAL APPAREL

201

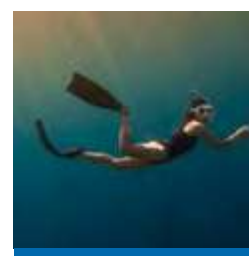

FINS
THE RIGHT THRUST FOR EVERYONE

210

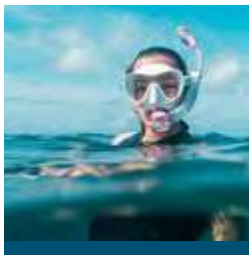

SNORKELING COMBOS
MASK + SNORKEL

320



SNORKELS
COMFY AND SAFE BREATHING

342

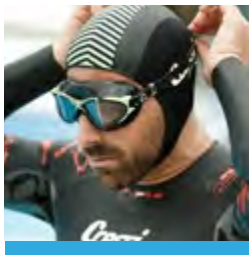

SWIMMING GOGGLES
IDEAL FOR SEA SWIMMING

356



SWIMMING ACCESSORIES
IDEAL FOR SEA SWIMMING

380



BAGS & BACKPACKS
EQUIPMENT TRANSPORTING

386

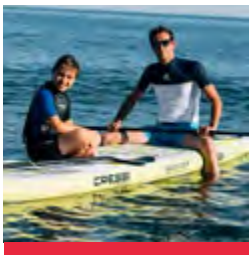

SUP & KAYAKS
INFLATABLE BOARDS

477

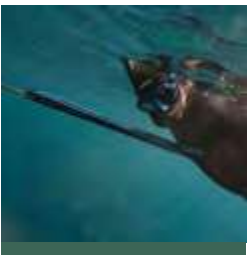

CRESSI SPEARFISHING
ARBALETE, WETSUITS & ACCESSORIES

490



WATCHES
WATERPROOF TIMEPIECES

536



BOTTLES & APPAREL
FOR CRESSIS ADDICTED

538



BRAND SUPPORT
FOR SHOPS & EVENTS

548

/ JOIN THE CRESSI FAMILY

JOIN THE

FA



**EGIDIO
CRESSI**



**NANNI
CRESSI**



Diving, Snorkeling and Water Sports are not 3%, 5% or 10% of our business. They are 100% of our business. We are focused only on water related sports.

We have been doing this, in the bay of Portofino, since 1946 and **this is what makes Cressi different.**

SINCE 1946

ANTONIO CRESSI & MARCO CRESSI



WE USE & TEST OUR PRODUCTS OURSELVES
OURSELVES
OURSELVES
OURSELVES
OURSELVES
OURSELVES
OURSELVES
OURSELVES
OURSELVES

/ HISTORY

WE ARE FAMILY

1930



1938

Brothers Egidio and Nanni Cressi start to handcraft the first masks and spearfishing guns. These are the origins of Cressi, the oldest scuba diving equipment company worldwide.



Aro AR47

1940

1943

The first Cressi mask, The Sirena, was hand crafted in 1943. It remained in the catalogue, with various updates, for more than 30 years.

1946

The Cressi company is officially founded in Genova, Italy.

1947

In 1947 the first oxygen rebreather was produced; Aro AR47. It was already highly advanced and fitted with sophisticated technical solutions, like the condensation receptacle.



Pinocchio



1950

1952

Pinocchio Mask, which makes equalization possible. It is a major innovation in the early '50s. It is the most famous and most sold mask in the world's history, and it is still included in the catalogue.



1953

Rondine Fins - Also in the field of fins, Cressi invented the model that has inspired all other manufacturers, the first floating model in the world.

1957

Cressi athlete Mario Catalani wins the first spearfishing World championship and get the gold medal in Jugoslavia.



1960

1965

Cressi opened one of the first workshops that specialized in producing optical masks. Thanks to Cressi, even people with visual defects could now get full enjoyment of the underwater universe.



1970

1970

Equi-vest - In 1970, Cressi was the first manufacturer in the world to produce Equi-Vest, a futuristic jacket that became one with the scuba tank, supplied by a hose that drew air directly from the first stage. This was the first incarnation of the modern BC.

1970

Rondine L long fins - The world leader of molding rubber fins, Cressi developed the Rondine L long fins, which enabled Jacques Mayol to go onto achieve his astonishing freediving records.

1979

Fins range - Alongside the various rubber fin models, a futuristic model was presented with a reinforced nylon blade, called the Rondine Gara, a fin that thirty years down the line is still going strong, and has been adopted by world class freedivers and spearfishermen the world over.





1980

1983
 Jacques Mayol, the first man in the world to challenge the 100m barrier. He reached a depth of 105 meters. The episode has gone down in history, the record was obtained in the waters of the island of Elba in 1983.

1988
 Apache Arbalète - Cressi produced a complete range of Arbalète spearguns to join the pneumatic guns, called the Apache, which very soon became the Champion speargun in the world.

1989
 Cressi athlete Renzo Mazzarri wins the spearfishing world title in Italy.



1990

1990
 Cressi continues its international expansion and the products are by now distributed in over 90 countries world wide.

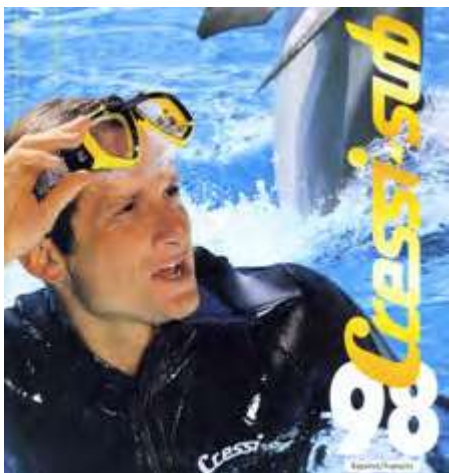

1999
 Cressi Athlete Umberto Pelizzari sets the freediving "No Limits Absolute Variable Weight" World Record in Portofino (Italy) reaching the depth of 150 meters.



Big Eyes Evolution

2000

2000
 Big Eyes was the first mask in the world with raked lenses in an upside-down teardrop shape, an innovative form that gives the diver a complete view of all the equipment worn. They became the most widely copied and imitated mask in the world, a gratifying appreciation of how far ahead Cressi is in the design of its products.



Leonardo

2010

2011
 The Leonardo dive computer watch is introduced, the first of the products designed in-house by Cressi Elettronica in order to guarantee optimum quality, safety and reliability.

2013
 The French freediving champion Guillaume Néry becomes a Cressi product endorser. The Giotto dive computer watch is introduced; it processes the data from repeat multi-day dives and dives with gas mixtures and also benefits from the Cressi RGBM algorithm. The Tracina wetsuit for spearfishing is introduced in a new and exclusive camouflage Dark Digital Specter Pat Cressi.



2020

2021
 Hydrosports is the result of Cressi's experience, consisting of tradition, innovation and quality, since 1946. With its close relationship to the sea environment, the Cressi team has been able to develop this new collection in response to the direct needs it encountered in practice and through water tests on its products.



TODAY

The Cressi company is still entirely owned by the Cressi family, which carries on with the same passion, the work started by brothers Nanni and Egidio Cressi. Its spirit lies in the manufacturing tradition, with a clear preference for the conception and realization of its products in-house, from the initial design through to the smallest details. Cressi focuses on those who love all facets of the aquatic world. The company has never exaggerated with successful products on the market, but has instead always invested in research and development to the benefit of quality and reliability, the evolution of materials.

OUR NUMBERS

- 77 YEARS OF EXPERIENCE**
- 9 BRANCHES AROUND THE WORLD**
- SALES IN 100 COUNTRIES WORLDWIDE**
- 100 PATENTS**
- 12 TIME SPEARFISHING WORLD CHAMPION**
- 7.000 REFERENCES**
- UNIQUE STYLE**

LIGURIA. OUR LAND, OUR SEA

It was to fish in the depths of Portofino and San Fruttuoso that, just before the Second World War, a group of friends thought of new equipment. Situated between the French border and Tuscany, Liguria is one of the smallest regions in Italy. The Italian riviera is reflected in the blue Mediterranean Sea, but is also surrounded by mountains that drop sheer into the sea. Vegetation forms the backdrop to some of the country's most popular and well-known seaside resorts.

The coasts are generally high, rocky, jagged, especially in the Riviera di Levante, while in the Ponente there is an almost perfect alternation between sheer cliffs and sandy beaches.

It couldn't be any other way, the strong passion for the sea finds its place in a unique setting with depths to explore.



"THE SEA IN LIGURIA, ESPECIALLY AROUND THE PORTOFINO PROMONTORY, IS EXTRAORDINARILY BEAUTIFUL AND, WHAT'S MORE, ACCESSIBLE WITHOUT TOO MANY PROBLEMS. THIS HAS PLAYED AN IMPORTANT ROLE IN THE BIRTH AND GROWTH OF A DIVING EQUIPMENT CENTRE IN THESE PARTS."

Antonio Cressi

“ I’M PROUD TO HAVE ALWAYS MANUFACTURED OUR MOST STRATEGIC PRODUCTS AT OUR HEADQUARTERS IN GENOVA, ITALY.”

ANTONIO CRESSI



THE CRESSI HEADQUARTERS

In 1989, the company was enlarged, moving it to Via Adamoli, along the Bisagno valley in Genoa. And then came the electronics department. Since 2008 we have created a research and development department for this sector and so we produce directly the many control instruments that are now used during diving. With 150 employees and

eight branches, Cressi is a world leader in the production of diving equipment, innovation, and development with exports accounting for 80% of turnover.

BUT THE ONLY ONE STILL RUN BY A FAMILY

WHERE WE ARE

WORLDWIDE

Our headquarters is based in **Genoa**, and we also have **nine branches: USA, Mexico, Brazil, France, Spain, China, Thailand, Australia and Koh Tao**. 70% of our products are made in Italy in our own factory, in Genoa. 10% of our products are made in our own production facility in Hungary and the remaining 20% is sourced from selected high-quality suppliers from Asia.

We have around **10,000** between shops & distributors all over the world, and our products are sold in over **100** countries.



CRESSI ITALY HEADQUARTERS

Cressi Sub S.P.A.
Via G. Adamoli, 501
16165 Genova - Italy
Tel. +39 010 830 791



CRESSI FRANCE

Cressi Sub France
Espace La Gaude, 9565 Route De Saint Laurent
06610 La Gaude - France
Tel. +33 049 329 0318



CRESSI U.S.A.

Cressi Sub U.S.A.
3 Rosol Lane, Saddle Brook - NJ 07663 - USA
Phone: (800) 338 9143
Phone: (201) 594 1450



CRESSI THAILAND

Cressi South East Asia Ltd
135/6-7 Moo 4 - Patak Road, Tambon Rawai Amphur Mueang, Phuket - Thailand 83130
Mobile: +66 (0) 643971234



CRESSI BRASIL

Cressi Brasil COM. MAT. ESP. LTDA
Avenida Padre Anchieta, 175 - Jordanópolis, São Bernardo do Campo SP, 09891-420
CNPJ: 35.112.958/0001-59

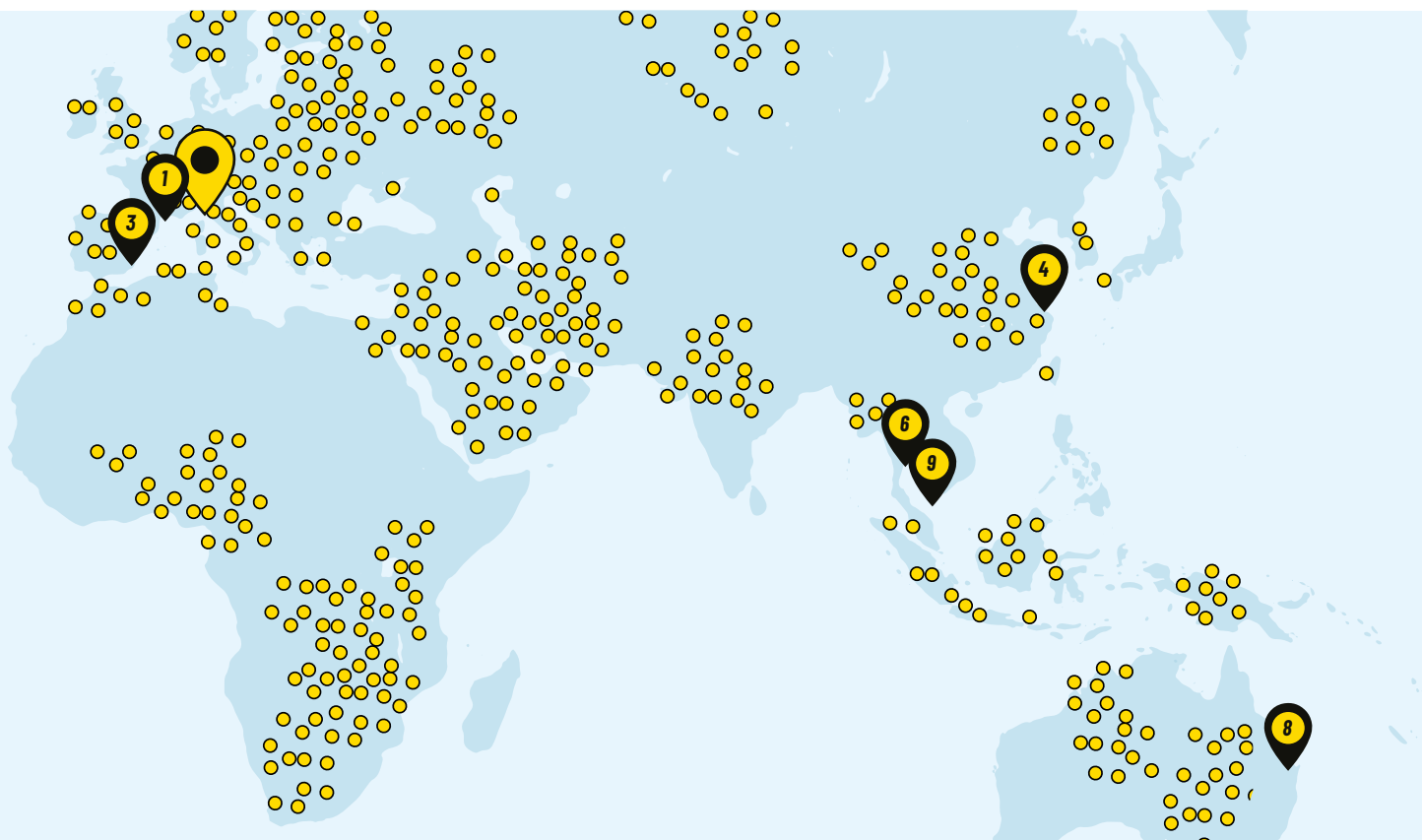

3

CRESSI ESPAÑA

Cressi-Sub España S.A.
 NIF: A60130978 - C/Castellassa, 24 Nave 3,
 Poligono Can Petit 08227 Terrassa Barcelona
 - Spain
 Tel. +34 937 841 888



4

CRESSI CHINA

Cressi China Watersports Products Co.,Ltd
 No.4 Zhuhai Road
 Kunshan City - Jiangsu province, China
 Phone +86 512-3668 0846



5

CRESSI MEXICO

Cressiwater S.A.P.I De C.V.
 Central de Abastos, Carretera - Cancun-
 Aeropuerto km 17, Cancun
 Quintana Roo. C.P.77565 - Mexico, VAT
 NO.CRE161110812
 Phone: +52 1 554 162-2052



8

CRESSI AUSTRALIA

Cressi Australia
 64 Edison Crescent, Baringa
 Queensland Australia, 4551
 marketing@cressi.com.au



9

CRESSI KOH TAO

Cressi South East Asia Ltd - Koh Tao
 5/14-15 M00 2, Koh Phangan - Koh Tao, Surat
 Thani 84360, Thailandia
 +66935791357

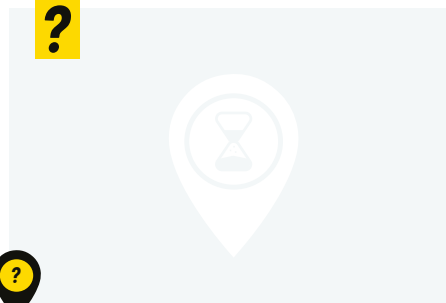

?

LOADING OUR NEXT DESTINATION...

CRESSI BUYER'S GUIDE 2025 COLLECTION

Cressi's legacy of innovation began in 1939 with two brothers who shared a passion for the sea and a gift for technical design and working with their hands. Egidio and Nanni Cressi began by crafting masks and spearguns that would allow them to move and hunt more efficiently in the waters near their home. By 1946 their designs and products had become so popular they founded the Cressi company in Genoa, Italy. Today, although Cressi is a worldwide leader in water sports manufacturing, it is still wholly owned by the Cressi family, and the commitment to innovation is still in the company's DNA. It has a long history of groundbreaking product development, and has often been the first to bring product advancements to the market.

This history of innovation is also made possible by a commitment to manufacture products in Italy at the Cressi facility. An investment in the latest manufacturing equipment and more than 16,000 square meters of roofed space, and the ability to have the designing and manufacturing process happen side by side has led to the absolute highest standards for quality. It also allows Cressi engineers to quickly develop, test and incorporate the latest materials and technologies.

Innovations continue, the results today are the same as they were in the beginning, the most advanced and best made products in the world.

Cressi's experience and the Italian know-how gives life to the new 2025 collection.



WE MANUFACTURE QUALITY SINCE 1946



OUR P



CRESSI, EQUIPMENT PARTNER OF Y-40®

CRESSI
SINCE 1940



In March 2019 Cressi officially became the partner of **Y-40® The Deep Joy**, the deepest pool with thermal water. From that moment on, the recreational diving and freediving equipment available at Y-40® is provided by Cressi.

Y-40® The Deep Joy is the place where everything is possible, where you can live the most amazing aquatic experiences.

4,300 cubic meters of thermal water where there are free diving and scuba diving courses. It's a safe environment for professional exercises and scientific research, in addition to being an amazing film set and area for photographic and advertising services. Y-40® has an area of 21x18m; the maximum depth is 42.15 meters with different platforms at intermediate depths and caves for technical activities.

The deep pool can be visited, it is possible to walk in the transparent tunnel that crosses the structure, discovering the magic of this big human aquarium.



Instagram icon [y40_thedeepjoy](#)

PARTNERS



BLACKWAVE 3S



BLACKWAVE



"WE KNOW THAT **FEELING**", is the motto of Italy's leading school for teaching board sports and promoting a lifestyle in contact with nature since 2011. Patents of the 3S (Surf, Skate and Snow) method are based in Liguria, Tuscany and France, with home base in Recco.

[@blackwave_it](#)

OUTDOOR PORTOFINO

Outdoor Portofino is a company that promotes sport, active tourism, and environmental education activities around the areas of Liguria's natural and cultural heritage. They offer numerous outdoor activities and experiences: kayaking, paddle boarding and snorkeling tours, suitable for beginners, intermediate and advanced levels. **Experience the area from a new perspective and enjoy the nature around you!**

SNORKELING SCHOOL



[@outdoorportofino](#)

OUR AMBA

/ OUR AMBASSADORS

ANDREW RAAK

USA



[raakbottomimaging](#)

Passionate about all aspects of the marine environment, Andrew has worked as a dive professional for more than a decade. He has a degree in Marine Science, a captain's license and dive instructor certification. He has traveled the world photographing in amazing locations.

ANNIE & TRISTAN GUTTRIDGE

UK



[annieguttridge.com](#)
[drguttridge.com](#)

Dr. Tristan and Annie Guttridge are marine researchers who specialize in the conservation of threatened sharks and rays. As the founders of the nonprofit Saving the Blue, the couple shares a passion for educating others whilst conducting meaningful research, which is published in world-renowned scientific journals. In addition to research, the couple also presents SCUBA and free dives shows, have written educational books, and have won prestigious awards.

ASIA BRYNNE

Hawaii



[asiabrynne](#)

I picked up my first disposable film camera at the age of 8 and never stopped shooting. The ocean is a place away from all of the noise, where you don't have to use words, time doesn't exist, and you can share space with animals. Being underwater is a break from the busyness of life.

STEVEN PAYNE

USA



[sevenpayne](#)

Steven grew up surrounded by open spaces, farms, and lakes; he loved exploring and seeing animals. His family moved to Florida, which cemented his love for the ocean. Steven is currently in the process of deploying artificial reefs: His nonprofit, The Reef Genesis Corporation, is his passion.

THE BUCKET LIST FAMILY

worldwide



[thebucketlistfamily](#)

The Gee family, just a typical family working from all over the world as Family Travel Journalists! Their story began in 2015, when they decided to sell everything and leave home for a trip around the world. They started an Instagram and YouTube channel called, The Bucket List Family.

THEO BARACASSA

Italy



[theobaracassa](#)

As long as I remember, the underwater world has always fascinated me. The practice of freediving in a natural environment allows me to evolve in a world where I fully feel my status as an explorer. This passion for the underwater world was naturally linked to photography. It's a sporting and artistic challenge that drives all my underwater photographic sessions. Today, Reunion Island offers me an infinite playground.

GIADA CAMPANELLA

Italy



[giadacampanella](#)

I am a dynamic yoga teacher, yoga for me is a connection to nature. In the water we are put to the test and we can only abandon ourselves to the water that envelops you and hugs you gently. When I dive underwater my mind is canceled, the body is abandoned and there are no other sounds other than that of your heart, then my mind calms down.

JUAN BONILLA

Mexico



[juanpopularcinema](#)

He is an underwater videographer who has directed and recorded underwater documentaries in diverse locations such as Indonesia, Costa Rica, Ecuador, the United States, the Netherlands, England, Croatia, and Tahiti, among others. His work extends beyond visual creation; he also collaborates on projects for non-governmental organizations, using his films to raise awareness about the conservation and protection of the oceans.

PIRRY

Colombia



[pirryofficial](#)

Pirry is a Colombian journalist, writer, photographer, documentalist, and important influencer who dedicated a good part of his journalist work to talking about the Ocean and denouncing problems such as illegal fishing, pollution, and many other difficulties facing the seas.

AMBASSADORS

/ OUR AMBASSADORS

CRAIG O'CONNELL

USA



[thesharkdoctor](#)

I'm from a small town located several hours from the ocean. But I always had a fascination with the ocean, a fascination that really came to fruition during my first shark encounter in the Florida Keys when I was 14. My free diving and scuba career began and has been growing ever since.

SHAWN JACKSON

Honduras



[shawnjacksongallery](#)

Shawn Jackson is a professional photographer originally from Roatan, Islas de la Bahia, Honduras, in the Caribbean. Jackson began his career as an underwater photographer and videographer. He later expanded his business, starting his own firm to include topside photography as well. His passion for nature photography has been the driving force in his career as an artist.

IG CALABRIA

Italy



[ig_calabria](#)

IG_Calabria is a territorial promotion project, one of the largest regional communities on Instagram. Through its network of creators, it tells the story of the territory, culture and food, through landscapes, the sea and people.

IGOR D'INDIA

Italy



[igordindia](#)

Igor has been able to combine his passion for outdoor adventure with his training in underwater filmmaking, camera drone pilot operation and advanced open water diving. He is deeply committed to participating in the global community who are fighting to protect the ocean.

FOUAD ZAYED & COLLIN COOPER

USA

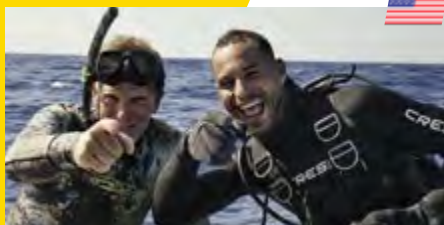

[foproductions](#)

FZ Productions is a production company located in Los Angeles, California. Fouad Zayed, also known as Fo, is an award-winning producer and director of photography at FZ Productions. Historic Shark Week producer company partners, week-long TV programming block created by the Discovery Channel, which features shark-based content.

GIULIA GABRIELLESCHI

Italy



[gabbri1996](#)

Giulia Gabrielleschi is an Italian swimmer, specialising in open water swimming. At the World Championships, she won a silver medal (Gwangju 2019) and a bronze medal (Budapest 2017) in the 5 km team event. The challenges continue and year after year she brings home excellent results.

ALEXANDRA JOHNSTON

UK



[alexinwaterlust](#)

She's a marine conservationist and activist. Her passion is cetaceans; orcas have her heart! She creates and film marine conservation documentary's and content, hoping everyone enjoys coming on ocean adventures with her, and fall in love with the big blue and its wonderful inhabitants

PAOLA GARGARI

Mexico



[paolagargari](#)

The founder of the Corazon del Mar Foundation is an influencer who works on fundraising and managing conservation projects for the oceans. As both a scuba diver and freediver, she is active on all social networks, where she promotes sustainable tourism and serves as a brand ambassador for various brands connected with the seas

KAYLEIGH & CAMERON GRANT

Hawaii



[mermaid.kayleigh](#)

Kayleigh and Cameron are passionate divers who strives to educate and encourage people to protect our oceans. As a marine conservationist, Kayleigh understands the importance of educating people about ocean conservation. Through her work at One Ocean Diving, she's able to inspire people's in protecting the world's sharks and marine life.

ELEONORA BERGAMASCO

Italy



[eleonorabergamasco](#)

One of the things I love most about diving is that once you put your head underwater you become an explorer of many small worlds, each with its own rhythms and rules, each rich in life and fascinating, curious creatures. Underwater, things get smaller, we are guests in an environment that does not belong to us, which is why we must get to know it and respect it without ever underestimating it. This is the only way to witness true spectacles of nature that remain indelible in the heart.

JAMES MUIR

England



[jarmuir](#)

Scuba instructor, conservation biologist and photographer. James has been a dive professional specialized in expedition diving and research in remote parts of the world. Is motivated by sharing our underwater world with future generations. Alongside, James is also a published photographer, skipper and freediver.

SEBITASTRIP

Mexico



[sebitastrip](#)

He is an influencer known for sharing his trips and experiences on all social networks with the intention of promoting sustainable tourism. He motivates people to explore the underwater world and connect with nature through activities such as diving and freediving. Additionally, he raises awareness about the importance of caring for the environment

/ OUR AMBASSADORS

RYAN WALTON



[wildlifewithryan](#)

Ryan Walton is a wildlife guide, Explorer and entrepreneur specializing in Wildlife Behavior! Upon Moving to Florida, in 2009, Sharks became the real passion! In 2019 Ryan opened his Florida Based Shark Ecotourism Company "Shark Tours Florida" and hosts tours daily. Ryan also leads travel trips, documenting them for his series "Wildlife with Ryan" on YouTube! Ryan's life mission is to inspire others to love and protect wildlife.

LEO MORALES



[leomoralessbuzo](#)

For many, scuba diving is an adventurous, recreational activity. For Cressi ambassador Leo Morales, scuba diving was therapy and the pathway to a second chance at life. After surviving a rare form of cancer, it was scuba diving that helped Leo to heal and find a deeper meaning into the purpose of his life.

FRANCESCO MAGISTRALI



[beyond.exploration](#)

Francesco is the creator of the Beyond Exploration brand. His family, his friends and his collaborators are all part of this team. In the name of Beyond Exploration's mission itself. Francesco's gaze is always turned towards the future. Adventure, travel and exploration are the means to deeply know the world, the Mystery and Humanity.

JASON WASHINGTON



[caymanjason](#)

For the past two decades, Jason has been a leader in the Cayman Islands water sports community. A 2017 International Scuba Diving Hall of Fame honoree, Jason's focus both locally and abroad has been on protecting the delicate marine life found in the waters of the C. Islands.

CHRISTINE WEST & ADAM MAIRE



[christine_regent_west](#)

After working as scuba instructors, adding cold-water diving was the greatest modification to their portfolio. Working together diving on a project in Alaska opened their eyes wide to documenting undersea life in extraordinarily different environments from the warm waters where they began.

CHRISTOPHER GILLETTE



[gatorboys_chris](#)

I'm born in Florida and have spent my life around the water. I love the freedom, weightlessness, and otherworldly views of diving. I try to use my passion to teach others about aquatic wildlife in the hopes they will learn to love them too, and ultimately help protect these fragile ecosystems.

NANJA VAN DEN BROEK



[nanjafreediver](#)

Nanja van den Broek started freediving in 2001 and in her first competition she immediately set two national records. In 2015, she set a new world record in the discipline Variable Weight with a dive to -130 meters, this record is also her 30th national record.

NATALIE PARRA



[natalieparra](#)

I'm from Southern California. I grew up playing in the ocean, but it wasn't until I was visiting the island of Oahu prior to moving there that I tried freediving for the first time. It felt like flying and I couldn't get enough of it. I started researching, taking courses and learning from fellow free divers.

PHILIP HAMILTON



[philip.hamilton.photography](#)

Philip Hamilton, filmmaker, photographer and author, is best known for his passion and dedication to ocean conservation. He has over thirty years diving and sailing experience and has documented most marine animals on the planet, from the majestic Blue whale to the smallest underwater critters.

OCEAN RAMSEY & J. OLIPHANT



[oceanramsey](#)

"Mr. and Mrs. Sharks." She is a marine biologist, shark and marine conservationist, professional freediver and scuba instructor, surfer, swimmer and professional model. Juan grew up surfing, he became a divemaster. He traveled the world with to help combat illegal fishing and whaling.

DR. NEIL HAMMERSCHLAG



[drneilhammer](#)

Dr. Neil Hammerschlag is a marine ecologist and shark researcher based out of Nova Scotia, Canada. He the President of Atlantic Shark Expeditions as well as the founder and Director of the Shark Research Foundation. He also holds a position as a courtesy faculty at Oregon State University.

TAGHRID ALHOWISH United Arab Emirates



[taghridalhowish](#)

Taghrid Alhowish is a real sport lover, her passion for the sea led her to explore the underwater world and so she started scuba and free diving. She's a Reporter and Presenter at MBC in Dubai and part of the 'MBC in a Week' show, presenting a segment that is dedicated to art and culture.

/ OUR AMBASSADORS

MARIANA SAAD VARGAS

Brazil



mari_on_bubbles

My name is Mariana, I'm 10 years old and I love traveling. When I was little I discovered water sports with my mother, and since then I started practicing, especially scuba diving. I love sharing some of my adventures inside and outside the sea. Who wants to discover the underwater world with me?

LAWRENCE WAHBA

Brazil



lawrence.wahba

I'm Lawrence Wahba, Ambassador of Cressi Brasil, an Emmy-winning nature documentary filmmaker, TV presenter, photographer, author and speaker. Diver since 1983 I made more than 5.000 dives in all oceans. I'm also one of the pioneers in underwater images, having been the first Brazilian to film a Great White Shark. In addition I recorded more than sixty other species of shark on five continents.

ROBERTO OCHOA

Ecuador



robertoochoahe

Roberto Ochoa is a Videographer for Planeta Azul, he started making wildlife videos at the age of 25 in the Galapagos Islands, Africa and North America. Beneath the world's waters lie landscapes, species, vegetation, and populations as diverse and splendid as those on land.

FABIO ROLLERI

Italy



fabiorollerri

Breathe is a project that aims to raise awareness of the beauty of underwater nature. We were born in contact with the sea and water has always been part of us. Below the water level everything stops, it's just you, your heartbeat and your room! Calm rules everything around you and it is at that point that you realize how wonderful there is underwater.

ARIANNA ROMERI

Italy



ariannaromeri_art

I grew up surrounded by equipment and the perfume of neoprene, watching my dad dive and waiting for my moment. I signed up for a freediving course. It wasn't love at first sight; I learned to appreciate it when it became the key to getting to know myself, through its timing, calmness and sensitivity.

CHIARA SALOMONI

Italy



chiaraphoto

I remember snorkeling all over the Mediterranean Sea, using my father's Cressi fins, which were oversized for my feet. I got into scuba and moved to the U.S. to follow my dream of becoming an underwater photographer, so that I would have the chance to be in the water as much as possible.

DEBORA RANIA

Italy



deborarania

My name is Debora Rania and I am a water-based photographer and content creator. On my Instagram channel @deborarania I share with my community my adventures around the world and my outdoor and wild life around Calabria, with the sea always in the background.

MATTIA MARZO

Italy



matthma

Freediver by vocation and traveller by passion. In my spare time I design excursions/vacations for my travellers and as a creator I produce content on my social profiles (@matthma). In possession of a Master freediver's certificate with which I teach freediving courses and workshops.

CACÀ FILIPPINI

Brazil



cacafilippini

I'm 45 years old, a communicator engaged in topics related to physical and mental well-being including running, diving and travel. I love uncomplicating various real-life topics. Diving transcends the sea, transporting me to a place where I renew my body, renew my energy and fill my mind with an immensity of possibilities!

YOKOTA TARO

Japan



Taro Yokota

Surgeon and free diving competitor. Whether in the operating room or underwater, calmness and precision in unpredictable situations are always required and are fundamental to his performance. He is the only freediver in his region, and spreading the joy of diving around is his life's work.

TESSON AURELIEN

France



aurel_kohlanta

Let's protect our oceans to preserve their wonders for as long as possible. Evolving in the water remains the best way to find peace, calm and tranquility. If you want to get face to face with yourself, dive in! Listen to your heartbeat and relax to the rhythm of your breathing. Follow us on this incredible epic journey into the depths!

SULUBAAÏ FOUNDATION

Philippines



sulubaaifoundation

Our approach consists in developing our objectives and making our site a model of sustainable management and a leader in ecosystem restoration. We believe that ecosystem preservation requires the involvement of local communities, and that the active management of marine protected areas is necessary to achieve results to deal with existing issues.

/ OUR AMBASSADORS

THEO KNEVEL

Netherlands



[theoknevel](#)

Theo is a scuba diving and advanced free diving instructor. He joined Cressi following a 10-plus-year career as a frogman in the Special Boat Service. He has been able to spread his passion for diving throughout the Caribbean. He is co-founder and chairman of the War Veterans Foundation.

LUCA TIXI

Italy



[outdoorportofino](#)

I was born and raised in Recco, at the time of high school, in a period of environmental militancy, the enlightenment arrives: I understand that my job will be to bring people into nature! After graduating in Marine Environmental Sciences at the University of Genoa, I founded Outdoor Portofino.

VOYAGES OF AGAPE

USA



[voyagesofagape](#)

Agápe is a 1984 Tayana Vancouver 42', hull #93. "Agápe" means unconditional love. She is a true blue water cruiser, and has already seen much of Mexico, the South Pacific, and beyond. For us Agápe is home. She is a safe and trustworthy vessel that will ferry us to the less seen places of the world.

FEDERICO TRAVERSO

Italy

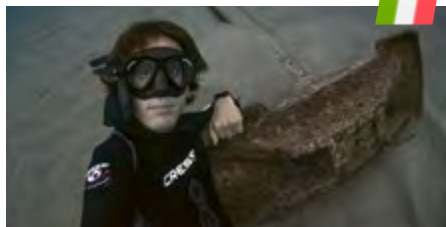

[skullphoto_aka_surfskull](#)

He is a young Italian designer and collaborates with Cressi for many years. Federico is passionate about the sea in all its forms, practice surfing and freediving but instead of hunting, he prefers to take pictures and videos. He starts each day with a morning swim session in the sea.

JIL VAN DIJK

Netherlands



[jilvandijk](#)

Jil van Dijk is a passionate filmmaker, speaker and storyteller with a deep love for the ocean. She believes that nature is one of the greatest teachers of our inner world, and invites us to explore our innate potential through her inspiring stories.

DEJBORDIN LIMSUPANARK

Thailand



[dejbordin](#)

Dejbordin Limsupanark (Wind), a professional photographer who is passionate about underwater photography. He is a specialist in the field of motorsport photography. Under the sea, he has experimented with photography techniques from his work experience. Applied to underwater photography Cressi's first piece of equipment. What impressed him was the Gara modular sprint fin used for scuba diving. Bring him along with underwater photography equipment. go freely

BE THE NEXT...



Join the Cressi family!

Our team is always looking for new talents and athletes who share our love for the sea!

Contact us at:

European countries - marketing.italia@cressi.com

American countries - marketing@cressiusa.com

store.cressi.com



CRESSI
SINCE 1946

INTERNATIONAL WARRANTY POLICY

In accordance with Directive 1999/44 EC, Cressi guarantees its products against inherent and operating defects. To offer better service to its customers and consumers, and to affirm the efficiency and quality of its manufacturing processes, it has decided to extend the terms of the guarantee as follows:

DIVE COMPUTERS

Two (2) years from the date of purchase (for rental or teaching use: 12 months for operating defects and 24 months for inherent defects).

Exceptions: Flooding caused by incorrect battery installation, LCD display in the case of damage due to negligence or blows, damage due to leaks of substances from the battery (the guarantee is valid if the computer is new and has not been used), damage caused by dead or non-functioning batteries, damage due to negligence, blows, or to normal wear and tear.

ANALOG DEVICES

Two (2) years from the date of purchase (for rental or teaching use: 12 months for operating defects and 24 months for inherent defects).

Exceptions: Damage due to negligence, blows, or normal wear and tear.

REGULATORS

Two (2) years from the date of purchase (for rental or teaching use: 12 months for operating defects and 24 months for inherent defects).

Exceptions: Consumable parts, damage due to negligence, blows, or normal wear and tear.

B.C.d.'S

Two (2) years from the date of purchase (for rental or teaching use: 12 months for operating defects and 24 months for inherent defects).

Exceptions: Consumable parts, damage due to scratches, punctures, abrasions, or chemical products (including chlorine), all damage due to exposure to the sun, damage due to negligence, blows, or normal wear and tear.

DRY SUITS

Two (2) years from the date of purchase (for rental or teaching use: 6 months for operating defects and 24 months for inherent defects).

Exceptions: Consumable parts, damage due to scratches, punctures, abrasions, or chemical products (including chlorine), all damage due to exposure to the sun, damage due to negligence, improper use, blows, or normal wear and tear.

MASKS, FINS, MOUTHPIECES, GOGGLES

Two (2) years from the date of purchase (for rental or teaching use: 12 months for good operations and 24 months for defects of conformity).

Exceptions: Alterations in the color of the silicone, all damage due to exposure to the sun or the effect of chemical or environmental agents, damage due to negligence, improper use, blows, or normal wear and tear.

SPEARGUNS, KNIVES, BAGS, WETSUITS, BOOTS, GLOVES, AND ALL REMAINING PRODUCTS AND CONSUMABLE PARTS

Two (2) years from the date of purchase (24 months for inherent flaws).

Exceptions: Damage due to scratches, punctures, abrasions, or chemical products (including chlorine), all damage due to exposure to the sun, damage due to negligence, blows, or normal wear and tear.



Photo by: Voyages of Agape

2025 TERMS AND CONDITIONS

With the merger of the two catalogs, the company has made an effort to help customers achieve free shipping. Previously, you needed to place an order of €500 in the Buyer's Guide and €500 in the BTS/HS catalog. Now, only a combined total of €750 is required, instead of €1000.

ORDER AMOUNT	EUROPEAN COUNTRIES	OTHER COUNTRIES
0 € - 299 €	ZONE 1: 29.99 € SHIPPING CONTRIBUTION ZONE 2: 39.99 € SHIPPING CONTRIBUTION	ORDER NOT ACCEPTED
300 € - 749 €	ZONE 1: 24.99 € SHIPPING CONTRIBUTION ZONE 2: 34.99 € SHIPPING CONTRIBUTION	ORDER NOT ACCEPTED
> 750 €	FREE SHIPPING	ORDER NOT ACCEPTED
> 3.000 €	FREE SHIPPING	ORDER ACCEPTED
Spare parts	ZONE 1 / 2: 19.99 € SHIPPING CONTRIBUTION	ORDER NOT ACCEPTED

ZONE	EUROPEAN COUNTRIES
ZONE 1	Austria - Belgium - Switzerland - Czech Republic - Germany - Denmark - France - UK (£) - Greece - Hungary Ireland - Italy - Luxembourg - Netherlands - Poland - Slovakia
ZONE 2	Albania - Bulgaria - Cyprus - Estonia - Finland - Croatia - Lithuania - Latvia - Malta - Norway Portugal Romania - Sweden - Slovenia

AFTER SALE PRICELIST CRESSI 2025

PRODUCT CATEGORY / SERVICE	PRICE (EXCLUDING VAT)
BATTERY CHANGE WATCH/COMPUTER	75.00
WATCH/COMPUTER STRAP REPLACEMENT	20.00
REGULATORS MAINTENANCE (1 st stage + 2 nd stage)	65.00
COMPLETE REGULATORS MAINTENANCE (1 st stage + 2 nd stage + octopus)	85.00
BCD MAINTENANCE	70.00
ZIPPER REPLACEMENT DRY SUIT	180.00
ZIPPER REPLACEMENT SEMI-DRY SUIT	120.00
CUF/ANKLE/COLLAR REPLACEMENT SUIT	30.00
OLEOPNEUMATIC GUN MAINTENANCE	40.00

/ OUR LABELS



Photo by: Voyages of Agape



This product can only be sold offline, it is not allowed to sell it online.

COMPUTER WATCHES/COMPUTERS

CARTESIO WATCH COMPUTER
MICHELANGELO DIVING COMPUTER

REGULATORS

T10-SC CROMO/GALAXY R REGULATOR (DIN/INT)

B.C.D'S

EMPEROR B.C.D.
COMMANDER EVOLUTION B.C.D.

NEOPRENE SUITS

COMFORT MAN MONOPIECE WETSUIT 7mm
COMFORT LADY MONOPIECE WETSUIT 7mm
COMFORT MAN MONOPIECE WETSUIT 5mm
COMFORT LADY MONOPIECE WETSUIT 5mm

FINS

ORIGIN HD FINS

MASKS

ZEUS MASK

BAGS & BACKPACKS

JUMBO TROLLEY BAG



The toughest and most reliable products specifically engineered for rental in the hardest conditions of use.

CONSOLES

DIGI2 DIGITAL CONSOLE RED

REGULATORS

AC2 COMPACT REGULATOR (DIN/INT)
AC2 COMPACT + OCTOPUS COMPACT (DIN/INT)
AC5 ZEN REGULATOR (DIN/INT)
AC5 ZEN + OCTOPUS ZEN (DIN/INT)

B.C.D'S

PATROL BCD
SOLID PLUS BCD
SOLID BCD DIVE CENTER EDITION

SCUBA SET

SOLID SCUBA SET (DIN/INT)
SOLID PLUS SCUBA SET (DIN/INT)

NEOPRENE SUITS

DIVER MAN MONOPIECE WETSUIT 5/7mm
DIVER LADY MONOPIECE WETSUIT 5/7mm
DIVER JR MONOPIECE WETSUIT 5mm
ENDURANCE MAN MONOPIECE WETSUIT 3mm
ENDURANCE LADY MONOPIECE WETSUIT 3mm
ENDURANCE KID MONOPIECE WETSUIT 3mm

RASH GUARDS

DIVE CENTER MAN RASH GUARD LONG/SL
DIVE CENTER LADY RASH GUARD LONG/SL
DIVE CENTER MAN RASH GUARD SHORT/SL
DIVE CENTER LADY RASH GUARD SHORT/SL

FINS

FREEFROG FINS
MAUI SAF FINS DIV-CEN

MASKS

MATRIX MASK
SIRENA MASK



A hi-tech product range for our professional retailers, that can be sold online only through the own website of a Cressi authorized retailer. This range therefore cannot be sold on marketplaces, e-procurement platforms or any third party website.

COMPUTER WATCHES/COMPUTERS

NEON WATCH COMPUTER
KING WATCH COMPUTER
RAFFAELLO DIVING COMPUTER
GIOTTO DIVING COMPUTER

CONSOLES

DIGI 2

REGULATORS

T10-SC PVD / MASTER REGULATOR (DIN/INT)
MASTER T10 SC CROMO REGULATOR (DIN/INT)
AC25 MASTER CROMO REGULATOR (DIN/INT)
MC11 SC ZEN PRO REGULATOR (DIN/INT)
MC11 ZEN REGULATOR (DIN/INT)
OCTOPUS MG BALANCED REGULATOR
OCTOPUS ZEN REGULATOR

B.C.D'S

AQUAWING MAX B.C.D
AQUAWING PLUS B.C.D
SCORPION B.C.D
ELETTRA B.C.D
EMPEROR B.C.D

NEOPRENE SUITS

GLACIER MAN/LADY DRY SUIT 4mm HD
ICE MAN/LADY SEMI-DRY WETSUIT 7mm
FACILE MAN/LADY MONOPIECE WETSUIT 8mm
FACILE MAN/LADY MONOPIECE WETSUIT 5mm
FAST MAN/LADY MONOPIECE WETSUIT 3/5/7mm
FISTERRA 2-PIECE WETSUIT 5/8mm

FINS

ORIGIN LD FINS
THOR EBS FINS
GARA TURBO CARBON XLD FINS
GARA TURBO CARBON MD FINS
GARA TURBO IMPULSE FINS
GARA MODULAR IMPULSE FINS
GARA TURBO BOOST FINS
GARA MODULAR BOOST FINS
GARA TURBO SPRINT FINS
GARA MODULAR SPRINT FINS
GARA MODULAR IMPULSE BLADES

MASKS

QUANTUM MASK
NAXOS MASK
PRISMA MASK
Z2 MASK
Z2 SMALL MASK
A1 MASK
ATOM MASK

COMBOS

QUANTUM + ITACA ULTRA DRY COMBO

SNORKELS

ITACA ULTRA DRY SNORKEL

BAGS & BACKPACKS

SEAHORSE TROLLEY BAG

KNIVES

LIZARD KNIFE
SNAKE KNIFE

SPEARGUNS

VICTORY RUBBER GUN
CHEROKEE POWER RUBBER GUN
CHEROKEE FAST RUBBER GUN
CHEROKEE EXO RUBBER GUN
MACH PNEUMATIC GUN W/REDUCER
MACH PNEUMATIC GUN

SPEARFISHING WETSUITS

POSIDONIA JACKET/PANTS WETSUIT 5/7mm
LAMPUGA MAN 2-PIECE WETSUIT 5/7+5mm
SEPIA JACKET/PANTS WETSUIT 3,5/5/7mm



Photo by: Theo Knevel



COMPUTERS

Photo by: Eleonora Bergamasco



RAFFAELLO



**RECTANGULAR
WIDE SCREEN
SCUBA DIVING
COMPUTER** «

MADE IN ITALY



PAOLO PIANFORINI
Project Manager Cressi Electronics



WHY BUY IT?

It is the most advanced computer in the Cressi range, encapsulating all the experience acquired in 15 years of development.

WHAT MAKES IT DIFFERENT?

It is the thinnest in its category, has an ergonomic shape, long battery life, and large, easy-to-read characters.

WHERE IS THE INNOVATION?

In the Raffaello computer, in addition to the possibility of switching between 3 O2 mixtures and the Freedive function, a choice of decompression in stages or with a ceiling function was added, which is useful for optimising ascent.



RAFFAELLO SPECIALIZED Retailer-Product

NEW COLORS 2025

ALGORITHM FOR MANAGING DIFFERENT HYPER-OXYGENATED MIXES DURING THE DIVE PHASE.
GAS1 21-50% GAS2 21-99% GAS3 21-99%

FREEDIVING FUNCTION

RECTANGULAR WIDE SCREEN SCUBA DIVING COMPUTER

Raffaello is a diving computer with a durable, scratch-resistant body and a large, easy-to-read display. It offers essential dive data, including surface time and desaturation time, with a long-lasting battery and user-replaceable feature. The DIVE program utilizes the Cressi RGBM Algorithm, allowing for precise dive planning and management of different air mixes. Safety features include oxygen toxicity indicators and

alarms for ascent speed violations. The FREE program provides comprehensive data for apnea diving, while the GAUGE program offers essential measurements and resettable chronometers. Raffaello's LOGBOOK stores up to 50 dives per program, and it includes a deep stage and ascent speed indicator for safe navigation. Reliability, performance, and convenience for divers.

TECHNICAL FEATURES

- High contrast display. Very large numbers, position for an easy reading.
- Intuitive, easy access menu
- 12/24 time and calendar
- Back lighted display
- Surface time, Desaturation time, no fly time
- Low battery warning
- Metric or imperial measures
- Long lasting battery
- User replaceable battery

DIVE (AIR/NITROX) PROGRAM

- Cressi RGBM Algorithm
- Complete dive data elaborator
- PPO2 1,2-1,6 setting
- Different air mixes manageable during the dive: GAS 1 21-50% GAS 2 21-99% GAS3 21-99%
- Graphis indicator of oxygen toxicity levels at CNS
- Safety stop indicator
- Safety factor can be set at different levels
- Altitude setting
- Uncontrolled emersion algorithm
- Possibility to alternate Nitrox and Air dives during desaturation
- Time visible during the dive
- Possibility to insert/cancel a Deep stop
- Loud alarms in case of violation of ascent speed, decompression stop or PPO2
- Ascent alarms can be disabled
- Total reset possible. Useful for rentals.
- Possibility to plan dives without decompression with surface interval
- Deep stage or Ceiling system
- Ascent speed indicator

FREE (APNEA) PROGRAM

- Visualization of all diving data
- Depth
- Water temperature
- Dive counter
- Maximum depth of the dive
- Dive time
- Surface interval between dives
- Duration of the diving session
- Surface interval
- Recovery time alarm

GAUGE PROGRAM (without decompression calculator)

- Depth/temperature indicator
- Average depth
- Dive time in minutes/seconds
- Depth chronometer can be reset
- Daytime visible during dive

OFFMODE

- Sensors are disabled to allow snorkeling and swimming

LOGBOOK to 70h or 60 dives



PRODUCT	CODE	RRP €
RAFFAELLO DIVING COMPUTER BLACK/BLUE	K5880052	399,99
RAFFAELLO DIVING COMPUTER BLACK/YELLOW	K5880051	399,99
RAFFAELLO DIVING COMPUTER BLACK/RED	K5880058	399,99
RAFFAELLO DIVING COMPUTER BLACK/WHITE	K5880053	399,99
RAFFAELLO DIVING COMPUTER BLACK/GREY	K5880057	399,99



GIOTTO



SPECIALIZED
Retailer-Product

NEW 2025

SCUBA DIVING COMPUTER

The Giotto is a dive computer with a fully modular design, featuring a robust and reliable structure that incorporates the technological improvement of the classic Giotto. Its ergonomic design and stainless steel finish give it a technical and elegant appearance. Featuring a large screen with User Friendly Display System (UFDS), it offers a clear and intuitive display. This advanced instrument supports full nitrox management, allowing the use of three different EAN mixtures during a single dive, in addition to Air, Nitrox and Gauge modes.

The zeroing function from the menu, ideal for rentals and diving courses, adds convenience. The integrated algorithm includes RGBM and supports deep stop as an additional option. Giotto is distinguished by the addition of an apnea function, a long-life battery, a depth stopwatch and the ability to use up to three different oxygen mixtures while diving. The Bluetooth connection option via an optional interface offers additional connectivity for an enhanced diving experience.

ALGORITHM FOR MANAGING DIFFERENT HYPER-OXYGENATED MIXES DURING THE DIVE PHASE. GAS1 21-50% GAS2 21-99% GAS3 21-99%

FREEDIVING FUNCTION

TECHNICAL FEATURES

- Intuitive and easy-to-access menu
- 12/24-hour format and calendar
- Backlit display
- Low battery warning
- Metric or imperial units
- Long battery life
- User-replaceable battery

AIR/NITROX DIVE PROGRAMME

- CRESSI RGBM algorithm
- Full processing of dive data
- Several air mixtures are manageable during the dive: GAS 1 21-50% GAS 2 21-99% GAS3 21-99%
- Graphic oxygen toxicity indicator at CNS
- Safety stop indication
- Safety factor setting at different levels
- Altitude setting
- Algorithm for managing uncontrolled ascents
- Possibility of alternating nitrox and air dives even during desaturation
- Time display during the dive
- Deep stop switchable / switchable
- Alarms in case of ascent rate, decompression stop or PPO2 violation
- PPO2 setting 1.2-1.6
- Possibility of excluding ascent alarms
- Possibility of total reset, useful when renting the instrument
- Planning of dives without decompression
- Maximum dive depth alarm
- Ascent rate indicator

APNEA PROGRAMME

- Display of all dive data
- Depth
- Water temperature
- Dive count
- Maximum dive depth
- Dive time
- Surface interval between dives
- Dive session duration
- Surface interval

DEPTH METER PROGRAM (without decompression calculator)

- Depth/temperature indicator
- Average depth
- Dive time in minutes/seconds
- Resettable depth stopwatch
- Time visible during dive

LOGBOOK up to 70h or 60 dives

- **SCHERMO DI PROTEZIONE** Replaceable display protection screen
 - Possibility of total reset, useful when renting the instrument
 - User-replaceable batteries
 - Structural metal ring for increased shock resistance
- INTERFACE** Optional with dive profile display



BLACK/SILVER



BLACK/PINK



BLACK/RED



BLACK/WHITE



3
Y° Æ

PRODUCT	CODE	RRP €
GIOTTO DIVING COMPUTER BLACK/SILVER	K5740057	329.99
GIOTTO DIVING COMPUTER BLACK/RED	K5740058	329.99
GIOTTO DIVING COMPUTER BLACK/WHITE	K5740150	329.99
GIOTTO DIVING COMPUTER BLACK/PINK	K5740054	329.99



MICHELANGELO

SCUBA DIVING COMPUTER

Michelangelo has a high contrast display. It is a scuba diving/apnea computer. It is an ideal computer for other underwater activities, thanks to the deactivation option of the "dive" functions that avoids unnecessary alarms ringing while you're snorkeling or swimming. The display is made of

technical polyolefin and the case is heavy duty, with a steel button. The underwater resistance is up to 150 m. TPU rubber wrist band with stainless steel buckle.



BLACK

BLACK/METAL

ALGORITHM FOR MANAGING TWO DIFFERENT HYPER-OXYGENATED MIXES DURING THE DIVE PHASE. GAS1 21-50% GAS2 21-99%
FREEDIVING FUNCTION

TECHNICAL FEATURES

- High contrast display with extra large numbers
- Easy access menu
- 12/24 time format with calendar
- High power backlit display
- Surf time, desaturation and no fly time calculator
- Lets you know when battery is empty
- Metric or imperial units

AIR/NITROX PROGRAM

- CRESSI RGBM algorithm
- Complete diving data processor
- PPO2 1.2-1.6 configuration
- It is possible to select hyper-oxygenated mixes during the dive phase. GAS1 21-50% GAS2 21-99%
- Graphic indicator of CNS toxicity level of oxygen
- Safety stop indicator
- Multiple level safety factor configuration
- Altitude configuration
- Algorithm for managing uncontrolled ascent
- Suitable for repeated, multiday decompression diving
- It is possible to alternate between nitrox and air diving even during desaturation
- Visualisation of time while diving
- Add / remove deep stop
- Alarm in case of breach of ascent speed, decompression or PPO2
- It is possible to disable the ascent alarms
- Possibility of eventual total reset, useful for renting purposes
- Planning: scrolling of no-decompression limits
- Maximum dive depth alarm

FREE (APNEA) PROGRAM

- Display of all diving parameters
- Depth
- Temperature
- Dip counter
- Maximum dive depth alarm
- Dive time
- Length of surface interval between each dive
- Length of diving session
- Depth, dive time and surface interval alarms
- Recovery time alarm
- Visualisation of time at dive phase

GAUGE PROGRAM (without decompression calculator)

- Depth/temperature indicator
- Average depth
- Dive time in minutes and seconds
- Resettable depth stopwatch
- Visualisation of time at dive phase

LOGBOOK up to 70h or 60 dives

Replaceable **PROTECTIVE DISPLAY** screen
User-replaceable batteries
Structural metal bezel that gives greater impact resistance

Optional **INTERFACE** with visualisation of diving profile

PRODUCT	CODE	RRP €
MICHELANGELO DIVING COMPUTER BLACK	KS850050	299,99
MICHELANGELO DIVING COMPUTER BLACK METAL	KS850850	299,99



DONATELLO

SCUBA DIVING COMPUTER

Donatello is an underwater and freediving computer. It is ideal for other water activities, thanks to the deactivation option of the "dive" functions, that avoids unnecessary alarms while snorkeling or swimming. It has a high contrast display. The heavy-duty case with a steel button

is fitted with a bezel which, like the protection, is plastic made. The underwater resistance is up to 150 m. The two-tone wrist band is made of TPU rubber with a stainless steel buckle.

FREEDIVING FUNCTION DIVE AIR/NITROX PROGRAM

TECHNICAL FEATURES

- High contrast display with extra large numbers
- Easy access menu
- 12/24 time format with calendar
- High power backlit display
- Surf time, desaturation and no fly time calculator
- Lets you know when battery is empty
- Metric or imperial units

DIVE (AIR/NITROX) PROGRAM

- CRESSI RGBM algorithm
- Complete diving data processor
- PPO2 1.2-1.6 configuration
- Graphic indicator of CNS toxicity level of oxygen
- Safety stop indicator
- Multiple level safety factor configuration
- Altitude configuration
- Algorithm for managing uncontrolled ascent
- Suitable for repeated, multiday decompression diving
- Visualisation of time while diving
- Add / remove deep stop
- Alarm in case of breach of ascent speed, decompression or PPO2
- It is possible to disable the ascent alarms
- Possibility of eventual total reset, useful for renting purposes
- Planning: scrolling of no-decompression limits
- Maximum dive depth alarm

FREE (APNEA) PROGRAM

- Display of all diving parameters
- Depth
- Temperature
- Dip counter
- Maximum dive depth alarm
- Dive time
- Length of surface interval between each dive
- Length of diving session
- Depth, dive time and surface interval alarms
- Recovery time alarm
- Visualisation of time at dive phase

GAUGE PROGRAM (without decompression calculator)

- Depth/temperature indicator
- Average depth
- Dive time in minutes and seconds
- Resettable depth stopwatch
- Visualisation of time at dive phase

LOGBOOK up to 70h or 60 dives

Replaceable **PROTECTIVE DISPLAY** screen
User-replaceable batteries

Optional **INTERFACE** with visualisation of diving profile



PRODUCT	CODE	RRP €
DONATELLO DIVING COMPUTER BLACK/BLUE	KS860022	249.99
DONATELLO DIVING COMPUTER BLACK/SILVER	KS860051	249.99
DONATELLO DIVING COMPUTER BLACK/RED	KS860058	249.99
DONATELLO DIVING COMPUTER BLACK/YELLOW	KS860052	249.99
DONATELLO DIVING COMPUTER BLACK/BLACK	KS865050	249.99
DONATELLO DIVING COMPUTER BLACK/PINK	KS860054	249.99



LEONARDO 2.0

SCUBA DIVING COMPUTER

An elegant expression of simple, functional design, the Leonardo is a must-have for divers entering the sport and those who "just want to dive." A single button interface makes it effortless to program Air, Nitrox and Gauge modes the first time a diver picks the computer up, and an edge-to-edge, high-definition screen gives large numerical displays in a computer that is still compact and travel-friendly. It is ideal for other water activities, thanks

to the deactivation option of the "dive" functions, that avoids unnecessary alarms while snorkeling or swimming. It has a high contrast display. The heavy-duty case with a steel button is fitted with a bezel which, like the protection, is plastic made. The underwater resistance is up to 120 m. The two-tone wrist band is made of TPU rubber with a stainless steel buckle.

TECHNICAL FEATURES

- High contrast display with extra large numbers
- Easy access menu
- 12/24 time format with calendar
- High power backlit display
- Surf time, desaturation and no fly time calculator
- Lets you know when battery is empty
- Metric or imperial units

DIVE (AIR/NITROX) PROGRAM

- CRESSI RGBM algorithm
- Complete diving data processor
- PPO2 1.2-1.6 configuration
- Graphic indicator of CNS toxicity level of oxygen
- Safety stop indicator
- Multiple level safety factor configuration
- Altitude configuration
- Algorithm for managing uncontrolled ascent
- Suitable for repeated, multiday decompression diving
- Visualisation of time while diving
- Add / remove deep stop
- Alarm in case of breach of ascent speed, decompression or PPO2
- It is possible to disable the ascent alarms
- Possibility of eventual total reset, useful for renting purposes
- Planning: scrolling of no-decompression limits
- Maximum dive depth alarm
- Visualisation of time at dive phase

GAUGE PROGRAM (without decompression calculator)

- Depth/temperature indicator
- Average depth
- Dive time in minutes and seconds
- Resettable depth stopwatch
- Visualisation of time at dive phase

LOGBOOK up to 70h or 60 dives

Replaceable **PROTECTIVE DISPLAY** screen
User-replaceable batteries

Optional **INTERFACE** with visualisation of diving profile



BLACK/BLACK



BLACK/GREY



BLACK/YELLOW



BLACK/BLUE



BLACK/PINK



WHITE/BLACK

PRODUCT	CODE	RRP €
LEONARDO DIVING COMPUTER BLACK/BLACK	K5770000	229,99
LEONARDO DIVING COMPUTER BLACK/GREY	K5770050	229,99
LEONARDO DIVING COMPUTER BLACK/YELLOW	K5770051	229,99
LEONARDO DIVING COMPUTER BLACK/BLUE	K5770052	229,99
LEONARDO DIVING COMPUTER BLACK/PINK	K5770054	229,99
LEONARDO DIVING COMPUTER WHITE/BLACK	K5770150	229,99



DONATELLO 2

NEW DESIGN 2025

2 INSTRUMENTS CONSOLE

COMPUTER + PRESSURE GAUGE

MINI PRESSURE GAUGE

It is a small, light-weight gauge that has been specifically designed to avoid excessive strain on the HP hose that connects to the first stage of the regulator. The instrument has a metal case in chromium plated brass and is therefore extremely strong. The front glass is made so that it also acts as a pressure relief valve. In the event of a sudden increase in pressure inside the instrument, the glass rises slightly, allowing the excess pressure to escape. The luminescent dial is calibrated up to 350 bar in the metric version and 5000 psi in the imperial one. The area below 50 bar is highlighted in red, the one between 50 and 200 is green and that from 200 to the end of the scale is light blue.

The instrument is housed in a small, modern shaped console, made from polycarbonate and desmopan, two materials that guarantee protection from shocks and scratches and which, at the same time, are very light.

On the top of the console there is a loop for fastening the instrument to the jacket so that it does not hang down with the risk of catching and damaging the environment.



ELITE CASE INCLUDED

PRODUCT	CODE	RRP €
DONATELLO CONSOLE 2 BAR	KS870210	389,99

DONATELLO 3

3 INSTRUMENTS CONSOLE

COMPUTER + COMPASS + PRESSURE GAUGE

It is the three-instrument version of the Donatello 2 console, equipped with the Donatello computer, a mini manometer and a compass.



ELITE CASE INCLUDED

PRODUCT	CODE	RRP €
DONATELLO CONSOLE 3 BAR	KS871210	449,99

BT INTERFACE RAFFAELLO

BLUETOOTH DOCKING STATION

External BT interface for sending data to your smartphone - compatible with Android (operating system version 9.0 onwards) and iOS (operating system version 12 onwards)
 The BT interface comes with an included and user-replaceable CR 2032 battery, which means that the

dive computer's internal battery is not consumed. The specific app is available on the google play store, app store, and Huawei app gallery.



Download "Cressi" App and explore your dives on your smartphone.



Android OS	From OS version 9.0 onwards
Apple IOS	From OS version 12 onwards
Connection	Bluetooth

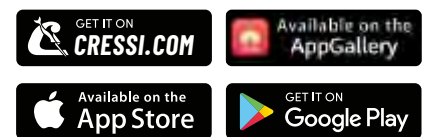

PRODUCT	CODE	RRP €
INTERFACE BT RAFFAELLO	K5881000	89,99

AVAILABLE FOR APPLE AND ANDROID

BT INTERFACE

BLUETOOTH DOCKING STATION

External docking station to send data to your smartphone – compatible with Android (from OS version 9.0 onwards) and iOS (from OS version 12 onwards). The docking station is equipped with a CR 2032 battery included and replaceable by the user, which allows not to consume the internal battery

of the dive computer. The specific App is available on the Google Play Store, App Store, Huawei App Gallery.



Download "Cressi" App and explore your dives on your smartphone.



INTERFACE COMPATIBILITY

Android OS From OS version 9.0 onwards

Apple IOS From OS version 12 onwards

Connection Bluetooth

Computer watches



PRODUCT	CODE	RRP €
INTERFACE BT	KS851000	89,99

PROTECTIVE LENS



PRODUCT	CODE	RRP €
PROTECTIVE LENS MICHELANGELO/DONATELLO SCREEN	KZ850098	12,50
PROTECTIVE LENS GIOTTO SCREEN	KZ740098	12,50
PROTECTIVE LENS LEONARDO SCREEN	KZ770098	12,50

DESCRIPTION:

The lens eliminates almost completely the effects of abrasion and shocks while making for perfect visibility.

COMPUTER BATTERY KIT



PRODUCT	CODE	RRP €
O-RING + CAP BIG SCREEN COMPUTER	KZ901001	-
BATTERY KIT CR2430 (O-RING+CAP) BIG SCREEN COMPUTER	KZ770094	-

DESCRIPTION:

Replacement spare part kits for big screen dive computers

COMPATIBILITY:

- Giotto computer
- Leonardo computer
- Donatello computer
- Michelangelo computer



PRODUCT	CODE	RRP €
BATTERY KIT FOR RAFFAELLO (CR2450 + O-RING)	KZ820094	-

DESCRIPTION:

Replacement spare part kits for rectangular wide screen dive computers

COMPATIBILITY:

- Raffaello computer

ELITE PROTECTIVE CASE



PRODUCT	CODE	RRP €
ELITE PROTECTIVE CASE	KZ700000	13,99

COMPUTER WATCHBAND



PRODUCT	CODE	RRP €
RECTANGULAR BIG SCREEN DIVE COMPUTER BAND BLACK	KZ885050	40,99
ROUND BIG SCREEN DIVE COMPUTER BAND BLACK/BLACK/GREY	KZ850097	29,99
ROUND BIG SCREEN DIVE COMPUTER BAND BLACK/BLACK/WHITE	KZ770000	29,99
ROUND BIG SCREEN DIVE COMPUTER BAND BLACK/BLUE/BLACK	KZ770020	29,99
ROUND BIG SCREEN DIVE COMPUTER BAND BLACK/PINK/BLACK	KZ770040	29,99
ROUND BIG SCREEN DIVE COMPUTER BAND BLACK/GREY/BLACK	KZ770050	29,99
ROUND BIG SCREEN DIVE COMPUTER BAND WHITE/BLACK/WHITE	KZ770150	29,99
ROUND BIG SCREEN DIVE COMPUTER BAND BLACK/YELLOW/BLACK	KZ770051	29,99

COMPUTER SCREW STRAP



PRODUCT	CODE	RRP €
SCREW WATCHBAND (1pair) BIG SCREEN COMPUTER	KZ760525	-

DESCRIPTION:

Stainless steel screw + nut for big screen dive computers

COMPATIBILITY:

- Giotto computer
- Leonardo computer
- Donatello computer
- Michelangelo computer
- Raffaello computer



COMPUTER WATCHES

Photo by: Wojciech Dopierala

CARTESIO ATELIER offline product

SCUBA COMPUTER WATCH

Cartesio has a diameter of only 48mm and a high contrast display of 35mm. It is a scuba diving/apnea watch-computer of extremely reduced dimensions. It is also an ideal watch for other underwater activities, thanks to the deactivation option of the "dive" functions that avoids unnecessary alarms ringing while you're

snorkelling or swimming. The display is made of mineral glass and the case is heavy duty with steel buttons that have an underwater resistance of up to 120m. Rubber wrist band with stainless steel buckle.

ALGORITHM FOR MANAGING TWO DIFFERENT HYPER-OXYGENATED MIXES DURING THE DIVE PHASE.
GAS1 21-50% GAS2 21-99%

FREEDIVE FUNCTIONS

USER FRIENDLY MENU

LONG-LIFE BATTERY

MINERAL GLASS

HEAVY DUTY CASE

4 OPERATIVE MODES

TECHNICAL FEATURES

- High contrast display with extra large numbers
- Easy access menu
- 12/24 time format with calendar and seconds
- Precision stopwatch
- Second time setting
- Alarm clock
- Backlit display
- Surf time, desaturation and no fly time calculator
- Lets you know when battery is empty
- Metric or imperial units

AIR/NITROX PROGRAM

- CRESSI RGBM algorithm
- Complete diving data processor
- PPO2 1.2-1.6 configuration
- It is possible to select hyper-oxygenated mixes during the dive phase. GAS1 21-50% GAS2 21-99%
- Graphic indicator of CNS toxicity level of oxygen
- Safety stop indicator
- Multiple level safety factor configuration
- Altitude configuration
- Algorithm for managing uncontrolled ascent
- Suitable for repeated, multiday decompression diving
- It is possible to alternate between nitrox and air diving even during desaturation
- Visualisation of time at dive phase
- Add / remove deep stop
- Alarm in case of breach of ascent speed, decompression or PPO2
- It is possible to disable the ascent alarms
- Indicates time at dive phase
- Possibility of eventual total reset, useful for renting purposes
- Planning: scrolling of no-decompression limits

FREE (APNEA) PROGRAM

- Display of all diving parameters
- Depth
- Temperature
- Dip counter
- Maximum dive depth
- Dive time
- Length of surface interval between each dive
- Length of diving session
- Depth, dive time and surface interval alarms
- Recovery time alarm
- Visualisation of time at dive phase

GAUGE PROGRAM (without decompression calculator)

- Depth/temperature indicator
- Average depth
- Dive time in minutes and seconds
- Resettable depth stopwatch
- Visualisation of time at dive phase

OFF MODE

Sensors disabled for snorkelling/swimming activities

LOGBOOK up to 70h or 60 dives

Optional INTERFACE with visualisation of diving profile

2 GAS



BLACK

BLACK/METAL

PRODUCT	CODE	RRP €
CARTESIO WATCH/COMPUTER BLACK	KS830050	399,99
CARTESIO WATCH/COMPUTER BLACK METAL	KS830850	399,99



NEON SPECIALIZED

SCUBA COMPUTER WATCH

Neon has a diameter of only 48 mm and a high contrast display of 37 mm. It is a scuba diving/apnea watch-computer of extremely reduced dimensions. It is also an ideal watch for other underwater activities, thanks to the deactivation option of the "dive" functions that avoids unnecessary alarms ringing while you're snorkeling

or swimming. The display is made of mineral glass and the case is heavy duty with steel buttons that have an underwater resistance of up to 120 m. PTU rubber wrist band with stainless steel buckle.

ALGORITHM FOR MANAGING TWO DIFFERENT HYPER-OXYGENATED MIXES DURING THE DIVE PHASE.
GAS1 21-50% GAS2 21-99%

FREEDIVE FUNCTIONS

USER FRIENDLY MENU

LONG-LIFE BATTERY

MINERAL GLASS

HEAVY DUTY CASE

4 OPERATIVE MODES

2 GAS



BLUE

GREY

BLACK



RED

GREEN

ORANGE

WHITE/LILAC

TECHNICAL FEATURES

- High contrast display with extra large numbers
- Easy access menu
- 12/24 time format with calendar and seconds
- Precision stopwatch
- Second time setting
- Alarm clock
- Backlit display
- Surf time, desaturation and no fly time calculator
- Lets you know when battery is empty
- Metric or imperial units

AIR/NITROX PROGRAM

- CRESSI RGBM algorithm
- Complete diving data processor
- PPO2 1.2-1.6 configuration
- It is possible to select hyper-oxygenated mixes during the dive phase. GAS1 21-50% GAS2 21-99%
- Graphic indicator of CNS toxicity level of oxygen
- Safety stop indicator
- Multiple level safety factor configuration
- Altitude configuration
- Algorithm for managing uncontrolled ascent
- Suitable for repeated, multiday decompression diving
- It is possible to alternate between nitrox and air diving even during desaturation
- Visualisation of time at dive phase
- Add / remove deep stop
- Alarm in case of breach of ascent speed, decompression or PPO2
- It is possible to disable the ascent alarms
- Indicates time at dive phase
- Device completely resettable, useful for renting purposes
- Planning: scrolling of no-decompression limits

FREE (APNEA) PROGRAM

- Display of all diving parameters
- Depth
- Temperature
- Dip counter
- Maximum dive depth
- Dive time
- Length of surface interval between each dive
- Length of diving session
- Depth, dive time and surface interval alarms
- Recovery time alarm
- Visualisation of time at dive phase

GAUGE PROGRAM (without decompression calculator)

- Depth/temperature indicator
- Average depth
- Dive time in minutes and seconds
- Resettable depth stopwatch
- Visualisation of time at dive phase

OFF MODE

Sensors disabled for snorkelling/swimming activities

LOGBOOK up to 70h or 60 dives

Optional INTERFACE with visualisation of diving profile



PRODUCT	CODE	RRP €
NEON WATCH COMPUTER BLUE	KS840020	329,99
NEON WATCH COMPUTER GREY	KS840050	329,99
NEON WATCH COMPUTER BLACK	KS840055	329,99
NEON WATCH COMPUTER RED	KS840058	329,99
NEON WATCH COMPUTER GREEN	KS840067	329,99
NEON WATCH COMPUTER ORANGE	KS840085	329,99
NEON WATCH COMPUTER WHITE/LILAC	KS840141	329,99

GOA

SCUBA COMPUTER WATCH

The GOA has a diameter of only 48mm and a high contrast display of 35mm. It is a scuba diving/apnea watch-computer of extremely reduced dimensions.

It is also an ideal watch for other underwater activities, thanks to the deactivation option of the "dive" functions that avoids unnecessary alarms ringing while you're snorkeling or swimming. The

display is made of mineral glass and the case is heavy duty with steel buttons that have an underwater resistance of up to 120m. Rubber wrist band with stainless steel buckle. Plastic/Steel bezel and back cover.

- MINERAL GLASS
- HEAVY DUTY CASE
- 4 OPERATIVE MODES
- FREEDIVE FUNCTIONS
- USER FRIENDLY MENU
- LONG-LIFE BATTERY

TECHNICAL FEATURES

- High contrast display with extra large numbers
- Easy access menu
- 12/24 time format with calendar and seconds
- Precision stopwatch
- Second time setting
- Alarm clock
- Backlit display
- Surf time, desaturation and no fly time calculator
- Lets you know when battery is empty
- Metric or imperial units
- Long-lasting battery
- Battery replaceable by user

AIR/NITROX PROGRAM

- CRESSI RGBM algorithm
- Complete diving data processor
- PPO2 1.2-1.6 configuration
- Graphic indicator of CNS toxicity level of oxygen
- Safety stop indicator
- Multiple level safety factor configuration
- Altitude configuration
- Algorithm for managing uncontrolled ascent
- Suitable for repeated, multiday decompression diving
- It is possible to alternate between nitrox and air diving even during desaturation
- Visualisation of time at dive phase
- Add / remove deep stop
- Alarm in case of breach of ascent speed, decompression or PPO2
- It is possible to disable the ascent alarms
- Indicates time at dive phase
- Possibility of eventual total reset, useful for renting purposes
- Planning: scrolling of no-decompression limits

FREE (APNEA) PROGRAM

- Display of all diving parameters
- Depth
- Temperature
- Dip counter
- Maximum dive depth
- Dive time
- Length of surface interval between each dive
- Length of diving session
- Depth, dive time and surface interval alarms
- Recovery time alarm
- Visualisation of time at dive phase

GAUGE PROGRAM (without decompression calculator)

- Depth/temperature indicator
- Average depth
- Dive time in minutes and seconds
- Resettable depth stopwatch
- Visualisation of time at dive phase

OFF MODE

Sensors disabled for snorkeling/swimming activities

LOGBOOK up to 70h or 60 dives

Optional INTERFACE with visualisation of diving profile



PRODUCT	CODE	RRP €
GOA WATCH COMPUTER BLACK/GREY	K5820050	319.99
GOA WATCH COMPUTER BLACK/BLUE	K5820052	319.99
GOA WATCH COMPUTER BLACK/WHITE	K5820053	319.99
GOA WATCH COMPUTER WHITE/PINK	K5820140	319.99
GOA WATCH COMPUTER WHITE/BLACK	K5820150	319.99



/ COMPUTER WATCHES

KING  **SPECIALIZED**
Retailer-Product

FREEDIVING COMPUTER WATCH

With a case diameter of only 48 mm and a high-contrast display of 35 mm, King is an extremely compact watch-computer specific for freediving. This innovative product boasts an algorithm developed in Cressi, which protects the freediver from the risk of Taravana, and a function that avoids the risk of pulmonary edema.

Mineral glass, heavy duty case with steel buttons for resistance to water pressure up to 120 m, metal bezel in AISI 316 steel with surface treatment and Inkfilled technology for the inscription, silicone and polyamide strap (to prevent tears and breakage) with stainless steel buckle.



SILICONE STRAP WITH POLYAMIDE CORE

METAL BEZEL IN AISI 316 STEEL WITH SURFACE TREATMENT



BLACK



BLUE



WHITE



TARAVANA PROTECTION ALGORITHM



BLOODSHIFT PROTECTION ALGORITHM



TIDE LEVEL INDICATOR



SINGLE DIP LOGBOOK

MINERAL GLASS	HEAVY DUTY CASE	METAL BEZEL	SILICONE STRAP WITH POLYAMIDE CORE
PROTECTION ALGORITHM FROM TARAVANA	EDEMA PROTECTION FUNCTION	USER FRIENDLY MENU	LONG-LASTING BATTERY

TECHNICAL FEATURES

- High contrast display
- Easy access menu
- 12/24 time format with calendar and seconds
- Precision stopwatch
- Timer (countdown)
- Second time setting
- Alarm clock
- Backlit display
- Tide indicator
- Low battery indicator
- Metric or imperial units
- Long-lasting battery
- Sleep mode to increase battery life
- Battery replaceable by user

FREE (FREEDIVING) PROGRAM

- Taravana risk reduction algorithm with 8 levels
- Pulmonary edema risk reduction function with approach dive calculation
- Display of all diving parameters
- Depth
- Temperature
- Dip counter
- Maximum dive depth
- Dive time
- Length of surface interval between each dive
- Length of diving session
- Maximum descent and ascent speed indication
- Depth, dive time and surface interval alarms
- Recovery time alarm
- Hydration alarm
- Alarms that can be set at dive phase
- Fresh/salt water setting
- Lock mode for snorkeling or swimming activities

LOGBOOK

- Variable data logging interval
- Available during the diving session
- Indication of session parameters and of each dive

INTERFACE

Optional with visualisation of diving profile



SILICONE PROTECTIVE LENS INCLUDED



PRODUCT	CODE	RRP €
KING WATCH COMPUTER BLACK	K5842050	349.99
KING WATCH COMPUTER BLUE	K5842020	349.99
KING WATCH COMPUTER WHITE	K5842030	349.99

NEPTO

FREEDIVING COMPUTER WATCH

With a case diameter of only 48 mm and a high-contrast display of 35 mm, Nepto is an extremely compact watch-computer specific for freediving. This innovative product boasts an algorithm developed in Cressi, which protects the freediver from the risk of Taravana, and a function that

avoids the risk of pulmonary edema. Mineral glass, heavy duty case with steel buttons for resistance to water pressure up to 120 m, rubber strap with stainless steel buckle.

- MINERAL GLASS
- HEAVY DUTY CASE
- PROTECTION ALGORITHM FROM TARAVANA
- EDEMA PROTECTION FUNCTION
- USER FRIENDLY MENU
- LONG-LIFE BATTERY



BLACK



BLUE



GREEN



TARAVANA PROTECTION ALGORITHM



BLOODSHIFT PROTECTION ALGORITHM



TIDE LEVEL INDICATOR



SINGLE DIP LOGBOOK

TECHNICAL FEATURES

- High contrast display
- Easy access menu
- 12/24 time format with calendar and seconds
- Precision stopwatch
- Timer (countdown)
- Dual timer
- Second time setting
- Alarm clock
- Backlit display
- Tide indicator
- Low battery indicator
- Metric or imperial units
- Long-lasting battery
- Sleep mode to increase battery life
- Battery replaceable by user

FREE (FREEDIVING) PROGRAM

- Taravana risk reduction algorithm with 8 levels
- Pulmonary edema risk reduction function with approach dive calculation
- Display of all diving parameters
- Depth
- Temperature
- Dip counter
- Maximum dive depth
- Dive time
- Length of surface interval between each dive
- Length of diving session
- Maximum descent and ascent speed indication
- 5-Depth, dive time and surface interval alarms
- Recovery time alarm
- Hydration alarm
- Alarms that can be set at dive phase
- Fresh/salt water setting
- Lock mode for snorkeling or swimming activities

LOGBOOK

- Variable data logging interval
- Available during the diving session
- Indication of session parameters and of each dive

INTERFACE

Optional with visualisation of diving profile



PRODUCT	CODE	RRP €
NEPTO WATCH COMPUTER BLACK	K5841050	259,99
NEPTO WATCH COMPUTER BLUE	K5841020	259,99
NEPTO WATCH COMPUTER GREEN	K5841098	259,99

BT INTERFACE WATCHES

BLUETOOTH DOCKING STATION

External docking station to send data to your smartphone – compatible with Android (from OS version 9.0 onwards) and iOS (from OS version 12 onwards). The docking station is equipped with a CR 2032 battery included and replaceable by the user, which allows not to consume the internal battery

of the dive computer. The specific App is available on the Google Play Store, App Store, Huawei App Gallery.



Download "Cressi" App and explore your dives on your smartphone.



INTERFACE COMPATIBILITY

Android OS From OS version 9.0 onwards

Apple IOS From OS version 12 onwards

Connection Bluetooth

Computer watches

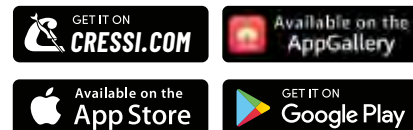

PRODUCT	CODE	RRP €
INTERFACE BT WATCH STYLE COMPUTER	KS822001	89,99

SILICONE LENS COVER

MAGNIFYNG EFFECT
+15% LARGER DISPLAY NUMBERS



PRODUCT	CODE	RRP €
SIL.PROTECTIVE LENS WATCH STYLE COMPUTER SCREEN	K5890000	11,99

DESCRIPTION:
The lens eliminates almost completely the effects of abrasion and shocks on both the display and the sides of the bezel, while making for perfect visibility. Thanks to this protection, the dive computer retains its pleasing, undamaged appearance even after prolonged, intensive underwater use.

COMPATIBILITY:
Cartesio, Neon, Goa, Nepto, King

BATTERY SPARE PARTS



PRODUCT	CODE	RRP €
O-RING + CASE BACK SCREWS WATCH STYLE COMPUTER	KZ901000	-
BATTERY KIT CR2450 (O-RING+SCREWS) WATCH STYLE COMPUTER	KZ820094	-

DESCRIPTION:
Replacement spare part kits for computer watches

COMPATIBILITY:
Cartesio, Neon, Goa, Nepto, King

COMP. WATCH SCREW STRAP



PRODUCT	CODE	RRP €
SCREW STRAP W/NUT WATCH STYLE COMPUTER	KZ805099	-

DESCRIPTION:
Stainless steel screw + nut for computer watches strap

COMPATIBILITY:
Cartesio, Neon, Goa, Nepto, King

SILICONE WATCHBANDS

POLYAMIDE CORE
PREVENT TEARS AND BREAKAGE



COMPATIBILITY:
Cartesio, Neon, Goa, King, Nepto

PRODUCT	CODE	RRP €
SILICONE BAND BLACK/BLACK/WHITE	KZ840055	41,99
SILICONE BAND BLUE/BLUE/WHITE	KZ842020	41,99
SILICONE BAND ORANGE/ORANGE/WHITE	KZ842085	41,99
SILICONE BAND WHITE/WHITE/BLACK	KZ820150	41,99

COMP. WATCHBANDS



COMPATIBILITY:
Cartesio, Neon, Goa, Nepto

PRODUCT	CODE	RRP €
BAND WHITE/WHITE/BLACK	KZ820150	31,99
BAND BLACK/BLACK/WHITE	KZ840055	31,99
BAND BLACK/BLUE/WHITE	KZ840020	31,99
BAND BLACK/ORANGE/WHITE	KZ840085	31,99
BAND WHITE/LILAC/WHITE	KZ840141	31,99
BAND BLACK/GREY/WHITE	KZ840050	31,99
BAND BLACK/LIME/WHITE	KZ840067	31,99
BAND BLACK/RED/WHITE	KZ840058	31,99
BAND BLACK/BLACK/GREY	KZ820050	31,99
BAND BLACK/BLACK/BLUE	KZ820052	31,99
BAND WHITE/WHITE/PINK	KZ820140	31,99
BAND BLACK/BLACK/BLACK	KZ8230050	31,99

WATCHBAND EXTENSOR

ADDITIONAL LENGHT
+4 IN / 10 CM



PRODUCT	CODE	RRP €
WATCHBAND EXTENSOR WATCH COMPUTER	KZ810000	24,99

DESCRIPTION:
Designed for wear the Cressi Dive Watch over a thick wetsuit. Made with the same high-quality rubber and corrosion resistant materials of the original straps. Easily clasps on the buckle end of computers strap increasing it length.

COMPATIBILITY:
Cartesio, Neon, Goa, Nepto, King

/ COMPUTERS COMPARISON TABLE



	RAFFAELLO	GIOTTO	MICHELANGELO	DONATELLO	LEONARDO 2.0	CARTESIO	NEON	GOA	
Case diameter	70x55	2 5/8 in · 67 mm	2 5/8 in · 67 mm	2 5/8 in · 67 mm	2 5/8 in · 67 mm	1 7/8 in · 48 mm	1 7/8 in · 48 mm	1 7/8 in · 48 mm	
Display diameter	51x35	1 7/8 in · 47 mm	1 7/8 in · 47 mm	1 7/8 in · 47 mm	1 7/8 in · 47 mm	1 3/8 in · 35 mm	1 3/8 in · 35 mm	1 3/8 in · 35 mm	
Case thickness	6/8 in · 18 mm	1 in · 27 mm	1 in · 27 mm	1 in · 27 mm	1 · 27 mm	2/4 in · 15.8 mm	2/4 in · 15.8 mm	2/4 in · 15.8 mm	
Weight	5 2/8 oz · 150 g	4 6/8 oz · 135 g	4 6/8 oz · 135 g	4 6/8 oz · 135 g	4 6/8 oz · 135 g	3 2/8 oz · 92 g	3 2/8 oz · 92 g	3 1/8 oz · 87 g	
Buttons	2	2	1	1	1	2	2	2	
Backlit display	Yes		Yes	Yes	Yes	Yes	Yes	Yes	
Dive programs	Air · Nitrox · Gauge · Free · 3 Gas	Air · Nitrox · Gauge · Free · 3 Gas	Air · Nitrox · Gauge · Free · 2 Gas	Air · Nitrox · Gauge · Free	Air · Nitrox · Gauge	Air · Nitrox · Gauge · Free	Air · Nitrox · Gauge · Free	Air · Nitrox · Gauge · Free	
Max dive time	1000 min	1000 min	1000 min	1000 min	1000 min	1000 min	1000 min	1000 min	
Max depth	393 ft · 120 m	393 ft · 120 m	393 ft · 120 m	393 ft · 120 m	393 ft · 120 m	393 ft · 120 m	393 ft · 120 m	393 ft · 120 m	
Average depth	Yes	Yes	Yes	Yes	Yes	Yes	Yes	Yes	
Depth sampling rate	0,5 second	0,5 second	0,5 second	0,5 second	0,5 second	0,5 second	0,5 second	0,5 second	
Algorithm	Trial-mixture - Cressi-Wienke RGBM with Uncontrolled Ascent Protection Algorithm	Trial-mixture - Cressi-Wienke RGBM with Uncontrolled Ascent Protection Algorithm	Dual-mixture Cressi-Wienke RGBM with Uncontrolled Ascent Protection Algorithm	Cressi-Wienke RGBM with Uncontrolled Ascent Protection Algorithm	Cressi-Wienke RGBM with Uncontrolled Ascent Protection Algorithm	Dual-mixture Cressi-Wienke RGBM with Uncontrolled Ascent Protection Algorithm	Dual-mixture Cressi-Wienke RGBM with Uncontrolled Ascent Protection Algorithm	Air/Nitrox Cressi-Wienke RGBM with Uncontrolled Ascent Protection Algorithm	
Thermometer	Resolution: 1°F / 1°C - Measuring field: 23°F + 104°F (-5°C + 40°C) - Precision: 3.6°F (2°C) / 10 min change temp	Resolution: 1°F / 1°C - Measuring field: 23°F + 104°F (-5°C + 40°C) - Precision: 3.6°F (2°C) / 10 min change temp	Resolution: 1°F / 1°C - Measuring field: 23°F + 104°F (-5°C + 40°C) - Precision: 3.6°F (2°C) / 10 min change temp	Resolution: 1°F / 1°C - Measuring field: 23°F + 104°F (-5°C + 40°C) - Precision: 3.6°F (2°C) / 10 min change temp	Resolution: 1°F / 1°C - Measuring field: 23°F + 104°F (-5°C + 40°C) - Precision: 3.6°F (2°C) / 10 min change temp	Resolution: 1°F / 1°C - Measuring field: 23°F + 104°F (-5°C + 40°C) - Precision: 3.6°F (2°C) / 10 min change temp	Resolution: 1°F / 1°C - Measuring field: 23°F + 104°F (-5°C + 40°C) - Precision: 3.6°F (2°C) / 10 min change temp	Resolution: 1°F / 1°C - Measuring field: 23°F + 104°F (-5°C + 40°C) - Precision: 3.6°F (2°C) / 10 min change temp	Resolution: 1°F / 1°C - Measuring field: 23°F + 104°F (-5°C + 40°C) - Precision: 3.6°F (2°C) / 10 min change temp
Visual and Auditory alarms	Yes	Yes	Yes	Yes	Yes	Yes	Yes	Yes	
Ascent alarm	On / Off	On / Off	On / Off	On / Off	On / Off	On / Off	On / Off	On / Off	
Deep stop	On / Off	On / Off	On / Off	On / Off	On / Off	On / Off	On / Off	On / Off	
Tissue saturation	9 saturation half-times ranging from 2.5 to 480 minutes	9 saturation half-times ranging from 2.5 to 480 minutes	9 saturation half-times ranging from 2.5 to 480 minutes	9 saturation half-times ranging from 2.5 to 480 minutes	9 saturation half-times ranging from 2.5 to 480 minutes	9 saturation half-times ranging from 2.5 to 480 minutes	9 saturation half-times ranging from 2.5 to 480 minutes	9 saturation half-times ranging from 2.5 to 480 minutes	
PO2 parameters	1.2 bar - 1.6 bar	1.2 bar - 1.6 bar	1.2 bar - 1.6 bar	1.2 bar - 1.6 bar	1.2 bar - 1.6 bar	1.2 bar - 1.6 bar	1.2 bar - 1.6 bar	1.2 bar - 1.6 bar	
FO2 parameters	Mix1: 21% to 50% - Mix2: 21% to 99% - Mix3: 21% to 99%	Mix1: 21% to 50% - Mix2: 21% to 99% - Mix3: 21% to 99%	Mix1: 21% to 50% - Mix2: 21% to 99%	Mix1: 21% to 50%	Mix1: 21% to 50%	Mix1: 21% to 50% - Mix2: 21% to 99%	Mix1: 21% to 50% - Mix2: 21% to 99%	Mix1: 21% to 50%	
Stopwatch during Gauge mode	Yes, resettable	Yes, resettable	No	No	No	Yes, resettable	Yes, resettable	Yes, resettable	
Clock (during the dive)	Yes	Yes	Yes	Yes	Yes	Yes	Yes	Yes	
No-fly time	Yes	Yes	Yes	Yes	Yes	Yes	Yes	Yes	
Altitude diving	Yes until 12,140 ft - 3,700m	Yes until 12,140 ft - 3,700m	Yes until 12,140 ft - 3,700m	Yes until 12,140 ft - 3,700m	Yes until 12,140 ft - 3,700m	Yes until 12,140 ft - 3,700m	Yes until 12,140 ft - 3,700m	Yes until 12,140 ft - 3,700m	
Log book	70h / 60 dives	70h / 60 dives	70h / 60 dives	70h / 60 dives	70h / 60 dives	70h / 60 dives	70h / 60 dives	70h / 60 dives	
Data acquisition frequency	5 second (Air-Nitrox-Gauge) 2 second (Free)	5 second (Air-Nitrox-Gauge) 2 second (Free)	5 second (Air-Nitrox-Gauge) 2 second (Free)	5 second (Air-Nitrox-Gauge) 2 second (Free)	5 second (Air-Nitrox-Gauge)	5 second (Air-Nitrox-Gauge) 2 second (Free)	5 second (Air-Nitrox-Gauge) 2 second (Free)	5 second (Air-Nitrox-Gauge) 2 second (Free)	
Temperature logbook acquisition	Yes	Yes	Yes	Yes	Yes	Yes	Yes	Yes	
Calendar	Yes	Yes	Yes	Yes	Yes	Yes	Yes	Yes	
Alarm clock	No	No	No	No	No	Yes	Yes	Yes	
Secondary time	No	No	No	No	No	Yes	Yes	Yes	
Stopwatch	No	No	No	No	No	Yes	Yes	Yes	
Battery type	CR 2450 3V	CR 2450 3V	CR 2430 3V	CR 2430 3V	CR 2430 3V	CR 2450 3V	CR 2450 3V	CR 2450 3V	
Estimate battery life	4 years	3+ years	3+ years	3+ years	2 years	4 years	4 years	4 years	
User replaceable battery	Yes	Yes	Yes	Yes	Yes	Yes	Yes	Yes	
Dive planner	Yes	Yes	Yes	Yes	Yes	Yes	Yes	Yes	
User replaceable watchband	Yes	Yes	Yes	Yes	Yes	Yes	Yes	Yes	
Watchband extension	Yes	No	No	No	No	Yes	Yes	Yes	
Unit system	Metric · Imperial	Metric · Imperial	Metric · Imperial	Metric · Imperial	Metric · Imperial	Metric · Imperial	Metric · Imperial	Metric · Imperial	
INTERFACE	K5881000	K5851000	K5851000	K5851000	K5851000	K5822001	K5822001	K5822001	



	KING	NEPTO
Case diameter	1 7/8 in · 48 mm	1 7/8 in · 48 mm
Display diameter	1 3/8 in · 35 mm	1 3/8 in · 35 mm
Case thickness	2/4 in · 15.8 mm	2/4 in · 15.8 mm
Weight	3 2/8 oz · 92 g	3 2/8 oz · 92 g
Buttons	2	2
Backlit display	Yes	Yes
Dive programs	Free · Lock · Sleep	Free · Lock · Sleep
Max dive time	-	-
Max depth	393 ft · 120 m	393 ft · 120 m
Average depth	-	-
Depth sampling rate	0,5 second	0,5 second
Algorithm	Taravana protection algorithm Edema protection algorithm	Taravana protection algorithm Edema protection algorithm
Thermometer	Resolution: 1°F / 1°C Measuring field: 23°F + 104°F (-5°C + 40°C) Precision: 3.6°F (2°C) / 10 min change temp	Resolution: 1°F / 1°C Measuring field: 23°F + 104°F (-5°C + 40°C) Precision: 3.6°F (2°C) / 10 min change temp
Visual and Auditory alarms	Yes	Yes
Alarms	Surf, Depth, Dive, Step time (available during the dive) Hydratation	Surf, Depth, Dive, Step time (available during the dive) Hydratation
Water salinity	Fresh/Salt	Fresh/Salt
Tide level indicator	Yes	Yes
No-fly time	Yes	Yes
Altitude diving		
Log book	up to 90 dives (available during the dive)	up to 90 dives (available during the dive)
Sample rate	off-0.5/1/2 sec	off-0.5/1/2 sec
Calendar	Yes	Yes
Alarm clock	Yes	Yes
Secondary time	Yes	Yes
Stopwatch + Dualtimer	Yes	Yes
Battery type	CR 2450 3V	CR 2450 3V
Estimate battery life	4 years	4 years
User replaceable battery	Yes	Yes
Sleep mode (battery safe)	Yes	Yes
User replaceable watchband	Yes	Yes
Watchband extension	Yes	Yes
Unit system	Metric · Imperial	Metric · Imperial
INTERFACE	KS922001	KS922001



Photo by: Wojciech Dopierala

DIVING IN

A TALK WITH OUR ENGINEERS

Cressi Elettronica



Cressi Elettronica was founded in 2008 to design, develop and manufacture state-of-the-art diving computers. We are based in Genoa, where our engineers and designers work to create high-quality products that meet customer needs.



Cressi Elettronica's philosophy is quite simple: Cressi computers and watches must be solid and reliable. We place a huge emphasis on the quality and safety of our products. **Every single model we develop is subjected to rigorous testing and quality control** through the use of specific machinery designed by our in-house team, which guarantees precise and accurate control, that couldn't be made furthermore.



W CRESSI

Cressi Elettronica dive computers are known for their advanced technological innovation, ergonomic design, and intuitive user interface. We want to provide divers with **reliable, high-quality instruments** to ensure a better diving experience. The accuracy of the information provided during the dive is a key feature of our products.

We actively collaborate with professional divers and industry experts to fully understand the needs and challenges faced during diving. This collaboration allows us to develop products that adapt to different needs and diving styles. We listen carefully to diver feedback and use it to guide our development process.

Our mission is to continue to be one of the leading companies in the dive computer industry. We are dedicated to constant research and innovation to redefine the standards of the diving industry; those who choose Cressi should be able to rely on increasingly reliable, high-quality, advanced instruments so they can feel free to explore the wonders of the underwater world safely.



Photo by: Kayleigh Burns & Cam Grant



SE70SM09

Photo by: VOYAGES OF AGAPE



DIGI 2



RESIDUAL GAS AUTONOMY INDICATOR (IN MINUTES)

AUTOMATIC ACTIVATION WITH CONNECTION TO THE TANK

PRESSURE GAUGE + DEPTH GAUGE

DIGITAL PRESSURE + DEPTH GAUGE

Digital dive computer and depth gauge engineered for precision and reliability in underwater exploration. With automatic activation upon tank connection, its high-contrast display offers clear visibility of essential dive metrics. From depth indicators spanning 0 to 120 meters to tank pressure indicators ranging from 0 to 300 bar, it provides comprehensive data for informed decision-making. Monitor water temperature (-10

to +50°C) and track residual gas autonomy, gas reserve, and maximum dive depth with precision. Boasting up to 1000 hours of underwater autonomy, it features a low battery indicator and patented self-diagnosis for seamless battery changes. Designed with a user-replaceable silicone protective shell, it ensures durability and ease of maintenance.

TECHNICAL FEATURES

- Automatic activation with connection to the tank
- High contrast display
- Depth indicator 0-120 meters
- Tank pressure indicator 0-300 bar
- Water temperature indicator -10/+50 °C
- Residual gas autonomy in minutes indicator
- Gas reserve below 50 bar indicator
- Maximum depth of the last dive
- Autonomy up to 1000 hours in immersion
- Low battery indicator
- Self-diagnosis for battery change (patented)
- User-replaceable silicone protective shell
- Dimensions: 9,9 x 5,2 x 2,8 cm
- Weight: 122 gr

SELF-DIAGNOSIS FOR BATTERY CHANGE (PATENTED)



LEAK TEST RUNNING

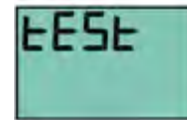

LEAK TEST RESULT

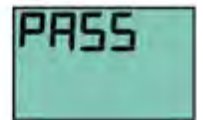

PRODUCT	CODE	RRP €
DIGI2 DIGITAL CONSOLE BLUE	KC800020	219.99
DIGI2 DIGITAL CONSOLE PINK	KC800040	219.99
DIGI2 DIGITAL CONSOLE BLACK	KC800055	219.99
DIGI2 DIGITAL CONSOLE RED	JKC800058	219.99

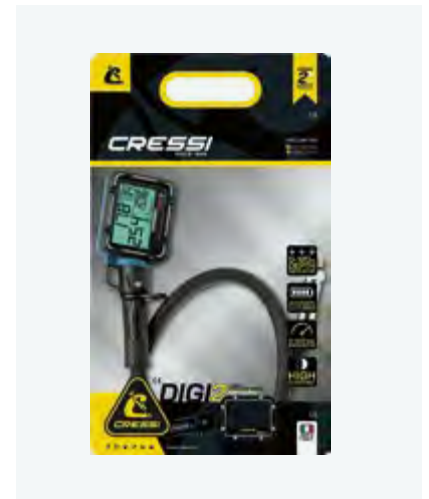

DIGI

DIGITAL PRESSURE GAUGE

Digi boasts automatic activation upon tank connection for seamless operation. Its high-contrast graphical display ensures optimal visibility, presenting critical dive data with clarity. Monitor tank pressure within a range of 0 to 300 bar and track water temperature (-10 to +50°C) for enhanced safety and comfort. Stay informed

of gas reserve levels below 50 bar with precision indicators. With an impressive autonomy of up to 1000 hours underwater, supported by a low battery indicator and patented self-diagnosis for battery changes, reliability is paramount. Featuring a user-replaceable silicone protective shell, durability meets convenience for extended use.

AUTOMATIC ACTIVATION WITH CONNECTION TO THE TANK | PRESSURE GAUGE

TECHNICAL FEATURES

- Automatic activation with connection to the tank
- High contrast display
- Tank pressure indicator 0-300 bar
- Graphical display
- Water temperature indicator -10/+50°C
- Gas reserve below 50 bar indicator
- Autonomy up to 1000 hours in immersion
- Low battery indicator
- Self-diagnosis for battery change (patented)
- User-replaceable silicone protective shell
- Dimensions: 9.9 x 5.2 x 2.8 cm = 3.89 x 2.04 x 1.10 in
- Weight: 122 g = 4.30 oz

SELF-DIAGNOSIS FOR BATTERY CHANGE (PATENTED)



PRODUCT	CODE	RRP €
DIGI DIGITAL PRESSURE GAUGE YELLOW BAR	KC790010	149,99

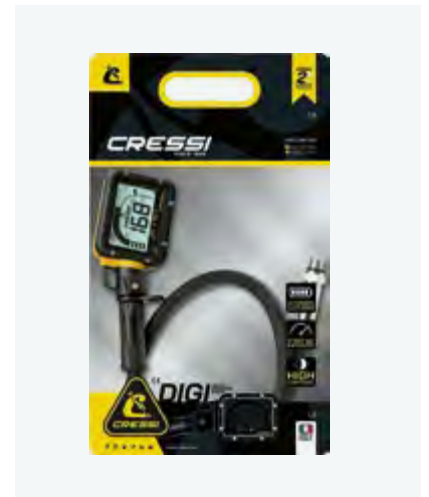



CP2

NEW DESIGN 2025

COMPASS + PRESSURE GAUGE

Compact and built to last, this console combines a Mini SPG and a compass. The textured boot is easy to handle, even while wearing gloves, and can be rigged with a clip or bungee and secured to the diver's BC for a streamlined profile in the water.

TECHNICAL FEATURES

- Compass with rotating bezel for easy navigation
- Pressure gauge dial is color-coded in red, green and blue for instant readability.
- Reads pressures to 350 bar.
- Both instruments built with chrome-plated brass case for maximum durability.
- Compact rubber boot is textured for a sure grip.
- One connection loop, at the top side, for attaching a clip or bungee.
- Weight of console: 420 g (includes hose).



350 BAR / 5000 PSI PRESSURE READINGS ROTATING BEZEL COMPASS



PRODUCT	CODE	RRP €
CONSOLE CP2 COMPASS+PRESSURE GAUGE VALE 300 C WHITE BAR	KC768300	169.99



PD2

NEW DESIGN 2025

NEW COLOR 2025

PRESSURE GAUGE + DEPTH GAUGE

Compact and built to last, this two-gauge console combines a Mini SPG and depth gauge. The textured boot is easy to handle, even while wearing gloves, and can be rigged with a clip or bungee and secured to the diver's BC for a streamlined profile in the water.

TECHNICAL FEATURES

- Pressure gauge dial is color-coded in red, green and blue for instant readability.
- Reads pressures to 350 bar.
- Mini-depth gauge reads to 70 meters.
- Maximum depth indicator.
- Luminescent face on the depth gauge.
- Depth indications spaced out in first 12 meters (40 feet) for precise readings during safety stops.
- Both instruments built with chrome-plated brass case for maximum durability.
- Compact rubber boot is textured for a sure grip.
- One connection loop, at the top side, for attaching a clip or bungee.
- Weight of console: 420 g (includes hose).



350 BAR / 5000 PSI PRESSURE READINGS 70 M DEPTH GAUGE

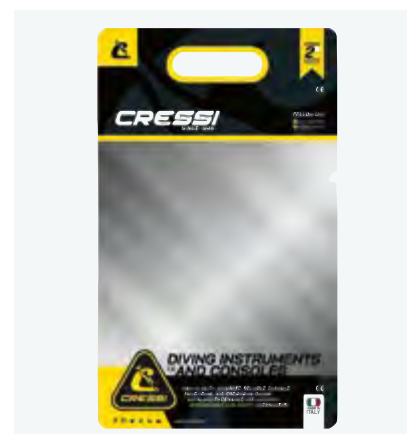

PRODUCT	CODE	RRP €
CONSOLE PD2 PRESSURE+DEPTH GAUGE VALE 300 C WHITE M/BAR	KC768500	199.99
CONSOLE PD2 PRESSURE+DEPTH GAUGE VALE 300 C BLACK M/BAR	KC768510	199.99

CPD3

NEW DESIGN 2025

COMPASS + PRESSURE GAUGE + DEPTH GAUGE

TECHNICAL FEATURES

- Compass with rotating bezel for easy navigation
- Pressure gauge dial is color-coded in red, green and blue for instant readability.
- Reads pressures to 350 bar.
- Mini-depth gauge reads to 70 meters.
- Maximum depth indicator.
- Compact rubber boot is textured for a sure grip.
- One connection loop, at the top side, for attaching a clip or bungee.
- Weight of console: 420 g (includes hose)



350 BAR / 5000 PSI PRESSURE READINGS

ROTATING BEZEL COMPASS

70 M DEPTH GAUGE

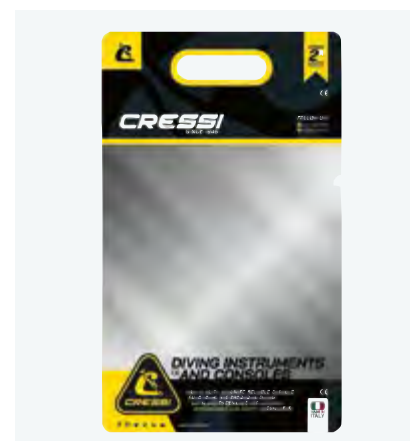

PRODUCT	CODE	RRP €
CPD3 PRES.+DEPTH GAUGE VALE 300 C WHITE+COMP. BAR	KC768400	239.99

DP 2

NEW DESIGN 2025

DEPTH GAUGE + PRESSURE GAUGE

Compact and built to last, this two-gauge console combines a Mini SPG and depth gauge. The textured boot is easy to handle, even while wearing gloves, and can be rigged with a clip or bungee and secured to the diver's BC for a streamlined profile in the water.

TECHNICAL FEATURES

- Pressure gauge dial is color-coded in red, green and blue for instant readability.
- Reads pressures to 350 bar.
- Mini-depth gauge reads to 70 meters.
- Maximum depth indicator.
- Luminescent face on the depth gauge.
- Depth indications spaced out in first 12 meters for precise readings during safety stops.
- Both instruments built with chrome-plated brass case for maximum durability.
- Compact rubber boot is textured for a sure grip.
- Two connection loops, one on each side, for attaching a clip or bungee.
- Weight of console: 420 g (includes hose).



70 M DEPTH GAUGE

350 BAR / 5000 PSI PRESSURE READINGS

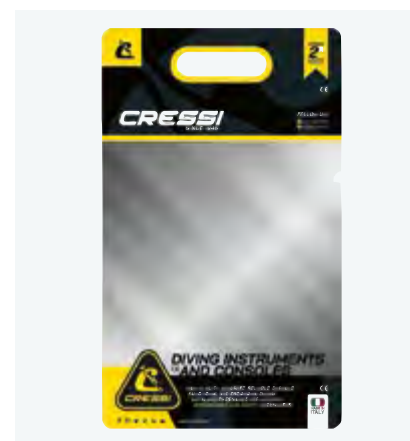

PRODUCT	CODE	RRP €
CONSOLE DP2 PRESSURE+DEPTH GAUGE VALE 300 C WHITE M/BAR	KC768200	169.99

MINI SPG

NEW DESIGN 2025 NEW COLOR 2025

350 BAR PRESSURE READINGS

PRESSURE GAUGE

TECHNICAL FEATURES

- Gauge dial is color-coded in red, yellow and green for instant readability.
- Reads pressures to 350 bar
- Rugged mini-gauge has a chrome-plated brass case.
- Compact rubber boot is textured for a sure grip.
- Connection loop up-top is perfect for attaching a clip or bungee.



BLACK

WHITE

PRODUCT	CODE	RRP €
MINI SPG w/ RUBBER HOUSING (BAR) WHITE	KK760800	89,99
MINI SPG w/ RUBBER HOUSING (BAR) BLACK	KK760810	89,99



350 BAR PRESSURE READINGS

MINI PRO SPG

NEW 2025

MINI SPG + HOSE

DESCRIPTION:

Mini SPG + hose without rubber boot (BAR), mineral glass and metal case



PRODUCT	CODE	RRP €
VALE 300 C PRO MINI SPG W/HOSE BLACK BAR	KK760720	109,99



WRISTBAND DEPTH GAUGE

NEW 2025

70 METERS READINGS

WITH RUBBER HOUSING

Mini analog depth gauge with new protection/wristband in soft thermoplastic, 55 mm stainless steel case with parabolic scale and maximum depth needle. SUPER VISION numbers and needles.



BLACK



WHITE



TECHNICAL FEATURES

- Case material: stainless steel
- Dial: SUPER VISION numbers and needles.
- Operation: membrane
- Special features: hand of maximum depth
- Instrument diameter: 55 mm
- Instrument height: 24.5 mm

PRODUCT	CODE		RRP €
WRIST BAND DEPTH GAUGE WHITE	CK760030		89.99
WRIST BAND DEPTH GAUGE BLACK	CK760050		89.99

COMPASS

+ WRISTSTRAP AND BCD HOLDER

Robust and accurate compass for underwater navigation that ensures accuracy and durability for a long time. The compass perfect for travelers. Scratch-resistant and durable oil-filled polycarbonate case. Highly luminous dial for easy reference in low light conditions. Side view window for easy and accurate navigation.

NORTHERN AND SOUTHERN HEMISPHERES COMPATIBILITY

ROTATING BEZEL COMPASS



PRODUCT	CODE		RRP €
COMPASS + FIXING KIT	KB760100		84.99

DIGI SMART COVER



CODE		RRP €
KZ790001		11.99

DESCRIPTION:
Smart display cover for DIGI & DIGI2 console

SUITABLE FOR:
DIGI & DIGI2 Console

DIGI CONSOLES COVERS



PRODUCT	CODE		RRP €
COVER DIGI2 BLACK	KZ790055		11.99
COVER DIGI2 BLUE	KZ790020		11.99
COVER DIGI2 WHITE	KZ790030		11.99
COVER DIGI2 PINK	KZ790040		11.99
COVER DIGI2 RED	KZ790058		11.99
COVER DIGI YELLOW	KZ791010		11.99

BATTERY KIT DIGI2



CODE		RRP €
KZ790003		-

DESCRIPTION:
Replacement battery CR2450 + O-Ring and rear cap kit

SUITABLE FOR:
DIGI2 Console
DIGI Console

HP HOSE



CODE		RRP €
KZ760501		52.99

DESCRIPTION:
HP hose for pressure gauge, length: 81 cm / 32 inch

COMPASS FOR CONSOLE 3



CODE		RRP €
KZ771000		43.99

DESCRIPTION:
Spare compass module for console

SUITABLE FOR:
CP2 Console
CPD3 Console
Donatello 3 Console

DEPTH GAUGE MODULE NEW 2025



WHITE	BLACK	BLACK/FLUO		RRP €
KZ760802	KZ760810	KZ760820		79.99

DESCRIPTION:
Mini-depth gauge module for console reads to 70 meters (230 feet)

SUITABLE FOR:
PD2 Console
CPD3 Console
Console 2
Mini spg
Mini pro spg
Wristband depth gauge



REGULATORS

1ST STAGE

T10 SC CROMO

2ND STAGE

GALAXY ADJUSTABLE

HIGH PERFORMANCE
REGULATOR

CERTIFIED
EN 250/2014
FOR COLD WATERS

Very high performance regulator, same mechanics as the T10 Master. Ideal for seasoned or professional divers who need extremely high

performing equipment that is both simple and resistant, without any of the usual accessories that may get damaged.

Set (INT) + Hose tot. weight 1075 gr

Set (DIN) + Hose tot. weight 957 gr



T10-SC CROMO GALAXY-R
INT REGULATOR



T10-SC CROMO GALAXY-R
DIN REGULATOR



Certification EN250/2014 for cold water

The T10-SEAL CHAMBER 1ST stage is environmentally sealed, protecting it against icing in cold water and against contamination from particulate matter in silty conditions.

RESULTS:

INHALE, EXHALE PRESSURE AND EXT WORK OF BREATHING

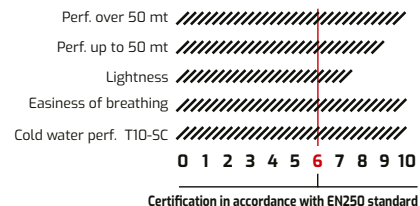
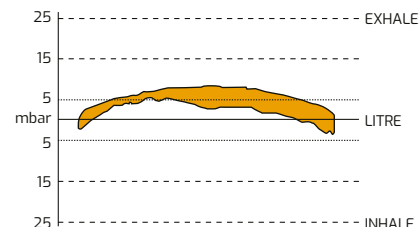

Certification in accordance with EN250 standard

TECHNICAL FEATURES 1ST STAGE

- Hyperbalanced diaphragm (Watertight chamber on T10-SC)
- 2 HP 7/16 UNF ports
- 4 MP 3/8 UNF ports
- Operating pressure: 300 bar (4350 psi) DIN Version, 232 bar (3365 psi) International version
- Calibration pressure: 10 bar
- High-capacity conical filter in chemically nickel-plated spherical bronze
- Removable nozzle in AISI 316 steel
- Hyperbalancing system
- Anti-pressure drop pneumatic spring
- Stainless steel calibration spring with micro opening treatment
- Low-friction technopolymer slider shaft
- Body protection in polyurethane thermoplastic
- Quantity of air supplied: 4500 l/min
- Weight, INT version: 720 gr
- Weight, DIN version: 602 gr

TECHNICAL FEATURES 2ND STAGE

- Pneumatically balanced
- Adjustable Venturi
- Adjustable inhalation effort
- Patented elliptical diaphragm
- Patented low-friction lever
- Air delivery system without injector
- Adjuster knob with dual OR
- Internal heat exchanger
- Cap opening with Cam-Lock
- Noise-absorbing technopolymer body
- Removable technopolymer deflector
- Removable mechanics
- Weight without hose: 202 gr

COMBINATION PERFORMANCE

- Average Cracking effort 3.5 mbar
- Average breathing effort 0.6 J/l

Jacketed hose extremely light and flexible weight: 153 gr

Certification EN250/2014 for cold water

PRODUCT	CODE	RRP €
T10-SC CROMO/GALAXY R (INT) REGULATOR	HX890000	469,99
T10-SC CROMO/GALAXY R (DIN) REGULATOR	HX890100	469,99



1ST STAGE T10 SC PVD 2ND STAGE MASTER

PVD COATING TREATMENT

TITANIUM 2ND STAGE COVER

HIGH PERFORMANCE REGULATOR

CERTIFIED EN 250/2014 FOR COLD WATERS

Very high performance regulator. Ideal for seasoned or professional divers who need extremely high performing equipment that is both

simple and resistant, without any of the usual accessories that may get damaged.

Set (INT) + Hose tot. weight 1080 gr

Set (DIN) + Hose tot. weight 962 gr



T10-SC MASTER INT REGULATOR



T10-SC MASTER DIN REGULATOR

RESULTS:
INHALE, EXHALE PRESSURE AND EXT WORK OF BREATHING

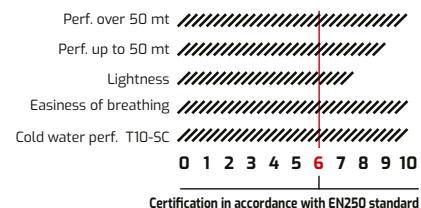
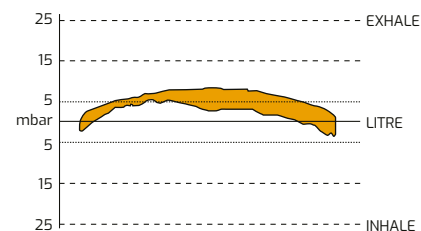

Certification in accordance with EN250 standard

TECHNICAL FEATURES 1ST STAGE

- Hyperbalanced diaphragm (Watertight chamber on T10-SC)
- 2 HP 7/16 UNF ports
- 4 MP 3/8 UNF ports
- Operating pressure: 300 bar (4350 psi) DIN Version, 232 bar (3365 psi) International version
- Calibration pressure: 10 bar
- Body coated with PVD process
- High-capacity conical filter in chemically nickel-plated spherical bronze
- Removable nozzle in AISI 316 steel
- Hyperbalancing system
- Anti-pressure drop pneumatic spring
- Stainless steel calibration spring with micro opening treatment
- Low-friction technopolymer slider shaft
- Body protection in polyurethane thermoplastic
- Quantity of air supplied: 4500 l/min
- Weight, INT version: 720 gr
- Weight, DIN version: 602 gr

TECHNICAL FEATURES 2ND STAGE

- Pneumatically balanced
- Adjustable Venturi
- Adjustable inhalation effort
- Patented elliptical diaphragm
- Patented low-friction lever
- Air delivery system without injector
- Adjuster knob coated with PVD process with dual OR
- Laser-etched titanium front piece
- Internal heat exchanger
- Cap opening with Cam-Lock
- Noise-absorbing technopolymer body
- Removable technopolymer deflector
- Removable mechanics
- Weight without hose: 207 gr

COMBINATION PERFORMANCE

- Average Cracking effort 3.5 mbar
- Average breathing effort 0.6 J/l

Jacketed hose extremely light and flexible weight: 153 gr

Certification EN250/2014 for cold waters



Certification EN250/2014 for cold water
The T10-SEAL CHAMBER 1ST stage is environmentally sealed, protecting it against icing in cold water and against contamination from particulate matter in silty conditions.

PRODUCT	CODE	RRP €
T10-SC PVD / MASTER (INT) REGULATOR	HX830000	499.99
T10-SC PVD / MASTER (DIN 300) REGULATOR	HX830100	499.99





SPECIALIZED
Retailer-Product



MADE IN ITALY

1ST STAGE

T10 SC CROMO

The t10-seal chamber 1st stage is environmentally sealed, protecting it against icing in cold water and against contamination from particulate matter in silty conditions. When paired with the master second stage, which includes an internal heat exchanger, this regulator is an excellent choice

2ND STAGE

MASTER CROMO

for divers exploring the most extreme cold water environments. Very high performance regulator. Ideal for seasoned or professional divers who need extremely high performing equipment that is both simple and resistant, without any of the usual accessories that may get damaged

Set (INT) + Hose tot. weight 1080 gr

Set (DIN) + Hose tot. weight 962 gr



Certification EN250/2014 for cold water

The T10-SEAL CHAMBER 1ST stage is environmentally sealed, protecting it against icing in cold water and against contamination from particulate matter in silty conditions. When paired with the Master second stage, which includes an internal heat exchanger, this regulator is an excellent choice for divers exploring the most extreme cold water environments.



T10-SC MASTER CROMO
INT REGULATOR



T10-SC MASTER CROMO
DIN REGULATOR

PRODUCT	CODE	RRP €
MASTER T10 SC CROMO REGULATOR INT	HX840000	449,99
MASTER T10 SC CROMO REGULATOR DIN	HX840100	449,99



HIGH PERFORMANCE
REGULATOR

STAINLESS STEEL
2ND STAGE COVER

CERTIFIED
EN 250/2014
FOR COLD WATERS

RESULTS:

INHALE, EXHALE PRESSURE AND EXT WORK OF BREATHING

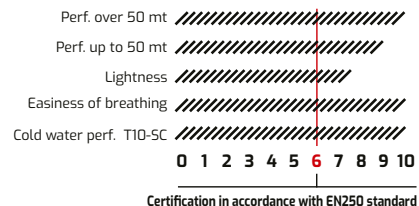
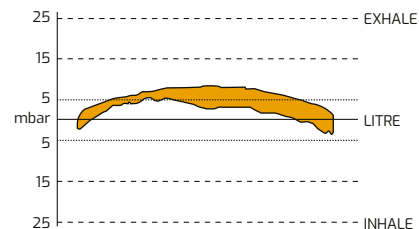

Certification in accordance with EN250 standard

TECHNICAL FEATURES 1ST STAGE

- Hyperbalanced diaphragm (Watertight chamber on T10-SC)
- 2 HP 7/16 UNF ports
- 4 MP 3/8 UNF ports
- Operating pressure: 300 bar (4350 psi) DIN Version, 232 bar (3365 psi) International version
- Calibration pressure: 10 bar
- High-capacity conical filter in chemically nickel-plated spherical bronze
- Removable nozzle in AISI 316 steel
- Hyperbalancing system
- Anti-pressure drop pneumatic spring
- Stainless steel calibration spring with micro opening treatment
- Body protection in polyurethane thermoplastic
- Quantity of air supplied: 4500 l/min
- Weight, INT version: 720 gr
- Weight, DIN version: 602 gr

TECHNICAL FEATURES 2ND STAGE

- Pneumatically balanced
- Adjustable Venturi
- Adjustable inhalation effort
- Patented elliptical diaphragm
- Patented low-friction lever
- Air delivery system without injector
- Adjuster knob coated with PVD process with dual OR
- Internal heat exchanger
- Cap opening with Cam-lock
- Noise-absorbing technopolymer body
- Removable technopolymer deflector
- Removable mechanics
- Weight without hose: 207 gr

COMBINATION PERFORMANCE

- Average Cracking effort 3.5 mbar
- Average breathing effort 0.6 J/l

Jacketed hose extremely light and flexible weight: 153 gr

Certification EN250/2014 for cold waters



CRESSI 3RD GENERATION
FIRST STAGE

FIRST STAGE
ADJUSTABLE PISTON

CERTIFIED
EN 250/2014

1ST STAGE AC25m 2ND STAGE MASTER CROMO

The AC25 is the third generation of Cressi's IP adjustable balanced piston first stage. It features 2 high-pressure ports and 5 low-pressure ports. 4 low-pressure ports are located on a rotating turret that ensures

that regulator and instrument connections are always in the right position. The fifth port is a co-axial Hi-Flow port and is located at the top of the turret.



The rotating turret swivels on 360° axis and features 5 low-pressure ports designed to allow the use of more connections without interfering between them. It features the external direct IP adjustment system that can be set using a simple Allen key. The hi-flow conic shape filter is the same for INT and DIN. The spring and the spring bush are coated preventing rust. Its technologically advanced design delivers consistent intermediate pressure and high performance even with low tank pressures. The AC25m it features a matte finish, in gun metal-coated brass. It is combined with the Master Cromo, the pneumatic balanced 2nd stage that features an elliptical shape and a lateral knob for Venturi adjustment.



AC25m MASTER CROMO
INT REGULATOR



AC25m MASTER CROMO
DIN REGULATOR

PRODUCT	CODE	RRP €
AC25m MASTER CHROME REGULATOR INT	HX900000	579.99
AC25m MASTER CHROME REGULATOR DIN	HX900100	579.99



RESULTS:
INHALE, EXHALE PRESSURE AND EXT WORK OF BREATHING

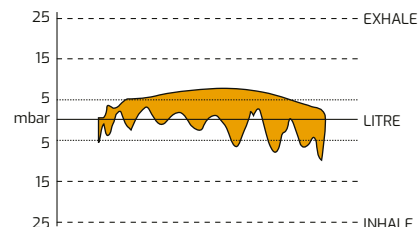

TECHNICAL FEATURES 1ST STAGE

- 3rd generation Cressi's IP adjustable balanced piston first stage
- 2x 7/16" HP ports UNF
- 5x 3/8" LP ports UNF, 1 port on turret top
- Operating pressure:
- INT version: 230 BAR | 3.336 PSI
- DIN version: 300 BAR | 4.351 PSI
- Calibration pressure: 9.8±10 BAR | 142±146 PSI
- 360° revolving head
- Realized in brass-coated, with a matte finish
- The sintered conical filter protects from any impurity
- External Direct IP adjustment system

TECHNICAL FEATURES 2ND STAGE

- Pneumatically balanced
- Adjustable Venturi
- Adjustable inhalation effort
- Patented elliptical diaphragm
- Patented low-friction lever
- Air delivery system without injector
- Adjuster knob coated with PVD process with dual OR
- Internal heat exchanger
- Cap opening with Cam-lock
- Noise-absorbing technopolymer body
- Removable technopolymer deflector
- Removable mechanics
- Weight without hose: 207 gr

COMBINATION PERFORMANCE

- Average breathing effort 0.78 J/L

**Jacketed hose extremely light and flexible
weight: 153 gr**

Certification EN250/2014 A>10° C



1ST STAGE
MC11 SC

2ND STAGE
ZEN PRO

SPECIALIZED
Retailer-Product

NEW 2025

HIGH PERFORMANCE
REGULATOR

CERTIFIED
EN 250/2014
FOR COLD WATER

ZEN is a state of calm attentiveness where actions are guided by intuition rather than by conscious effort.** This is our ZEN of diving—you become one with the water, calm, attentive, breathing intuitively without effort. This regulator features an ultra-lightweight and compact design to minimize jaw strain, even on extended dives. Paired with our hyperbalanced diaphragm system MC11 SC, it provides powerful, smooth breathing for any

water environment around the world - even under ice. This first stage is a dry sealed, cold-water suitable hyperbalanced diaphragm system, power-packed into an ultra-compact size. In order to achieve extremely high performance in low temperature environments, the ZEN PRO second stage in particular was designed with the special thermoconductive thermoplastic neopolymer that has the capacity to transfer heat like a metal while

preserving the chemical resistance and physical and mechanical properties of a conventional thermoplastic. This makes it possible to drastically reduce the weight while delivering heat conductivity on par with metal regulator cases. Thanks to this material and a specially conceived purge valve, it passes the strict EN250 cold water tests

Set (INT) + Hose tot. weight *897 gr

Set (DIN) + Hose tot. weight *750 gr



TECHNICAL FEATURES 1ST STAGE

- First stage MC11SC
- Hyperbalanced diaphragm technology
- Ultra compact: Only adds 6.5mm and 30 grams to MC11
- 2 outlets HP 7/16 UNF
- 4 outlets MP 3/8 UNF
- Service pressure: 300 bar (4350 psi) DIN version, 232 bar (3365 psi) INT version
- Calibration pressure: 9.5-10 Bar
- Brass body Electroless Nickel plated
- Liquid silicone molded diaphragm ensures best breathing effort
- High capacity conical filter electroless nickel plated
- Aisi 316 removable nozzle
- Shockproof technopolymer protections
- Cressi PressureSync system for a smoother inhalation pressure
- New low-effort adjustment spring
- Flow rate: 4500 l/min
- INT version weight: 603 gr
- Din version weight: 458 gr

TECHNICAL FEATURES 2ND STAGE

- Downstream system
- Adjustable Venturi effect
- Patented antifriction lever
- Big purge button
- Double injection purge button
- Radial pressure transmission openings
- Anti-scratch surface
- Bayonet-type cap holder with security lock
- Removable exhaust tee without tools
- Weight without hose: 149 gr



Certification EN250/2014 for cold water

The MC11-SEAL CHAMBER 1ST stage is environmentally sealed, protecting it against icing in cold water and against contamination from particulate matter in silty conditions.



MC11 SC
INT REGULATOR



MC11 SC
DIN REGULATOR

PRODUCT	CODE	RRP €
MC11 SC/ZEN PRO REGULATOR INT SILVER	HZ792051	349.99
MC11 SC/ZEN PRO REGULATOR DIN SILVER	HZ792151	349.99



1ST STAGE
MC11

2ND STAGE
ZEN

SPECIALIZED
Retailer-Product

NEW 2025

HIGH PERFORMANCE
REGULATOR

CERTIFIED
EN 250/2014

"ZEN is a state of calm attentiveness where actions are guided by intuition rather than by conscious effort."* This is our ZEN of diving—you become one with the water, calm, attentive, breathing intuitively without effort. This regulator features an ultra-lightweight and compact design to minimize jaw

strain, even on extended dives. Paired with our hyperbalanced diaphragm system MC11, it provides powerful, smooth breathing for any warm water environment around the world.

Set (INT) + Hose tot. weight *718 gr

Set (DIN) + Hose tot. weight *571 gr



TECHNICAL FEATURES 1ST STAGE

- Balanced diaphragm
- 2 outlets HP 7/16 UNF
- 4 outlets MP 3/8 UNF
- Service pressure: 300 bar (4350 psi) DIN version, 232 bar (3365 psi) INT version
- Calibration pressure: 9.5-10 Bar
- Brass body Electroless Nickel plated
- High capacity conical filter electroless nickel plated
- Aisi 316 removable nozzle
- Hyperbalanced Diaphragm technology
- Cressi PressureSync system for a smoother inhalation pressure
- New low-effort adjustment spring
- Elastomer protector
- Flow rate: 4500 l/min
- INT version weight: 569 gr
- Din version weight: 422 gr

TECHNICAL FEATURES 2ND STAGE

- Downstream system
- Adjustable Venturi effect
- Patented antifriction lever
- Dual-injection, enlarged purge button
- Radial pressure transmission openings
- Anti-scratch surface
- Bayonet-type cap holder with security lock
- Removable exhaust tee without tools
- Weight without hose: 149 gr



PRODUCT	CODE	RRP €
MC11/ZEN REGULATOR INT GOLD	HX791011	299,99
MC11/ZEN REGULATOR DIN GOLD	HX791111	299,99



1ST STAGE MC9 SC 2ND STAGE COMPACT PRO

In order to achieve extremely high performance in low temperature environments, the second stage in particular was designed with the special Thermoconductive Thermoplastic Neopolymer that has the capacity to transfer heat like a metal while preserving the design flexibility, chemical resistance, and physical and mechanical properties

of a conventional thermoplastic. That is, it makes it possible to drastically reduce the weight while delivering heat conductivity on a par with metal cases. Thanks to this material and a specially conceived purge valve, it passes EN 250 cold water tests.

Set (INT) + Hose tot. weight 943 gr

Set (DIN) + Hose tot. weight 803 gr



Certification EN250/2014 for cold water

The MC9-SEAL CHAMBER 1ST stage is environmentally sealed, protecting it against icing in cold water and against contamination from particulate matter in silty conditions.



MC9 SC COMPACT PRO INT REGULATOR



MC9 SC COMPACT PRO DIN REGULATOR

PRODUCT	CODE	RRP €
MC9-SC /XS COMPACT PRO REGULATOR INT	HX782000	329.99
MC9-SC /XS COMPACT PRO REGULATOR DIN	HX782100	329.99



HIGH PERFORMANCE REGULATOR

CERTIFIED EN 250/2014 FOR COLD WATERS

RESULTS:

INHALE, EXHALE PRESSURE AND EXT WORK OF BREATHING

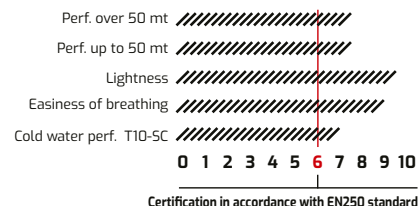
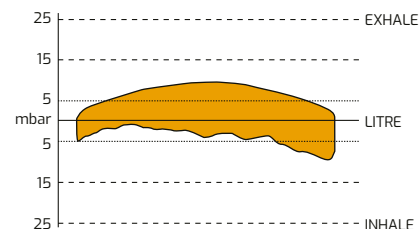

TECHNICAL FEATURES 1ST STAGE

- Balanced diaphragm (seal chamber for MC9SC)
- 2 outlets HP 7/16 UNF
- 4 outlets MP 3/8 UNF
- Service pressure: 300 bar (4350 psi) DIN version, 232 bar (3365 psi) Yoke version
- Calibration pressure: 10 Bar
- Brass body Electroless Nickel plated
- High capacity conical filter electroless nickel plated
- Aisi 316 removable nozzle
- Hyper-balancing
- Anti-pressure drop pneumatic spring
- Setting spring: stainless steel with micro opening treatment
- Cressi PressureSync system for a smoother inhalation pressure
- Elastomer protector
- Flow rate: 4500 l/min
- Yoke version weight: 650 gr
- Din version weight: 510 gr

TECHNICAL FEATURES 2ND STAGE

- Improved reliability front cover (more impact resistant)
- Downstream system
- Adjustable Venturi effect
- Patented antifriction lever
- Thermoconductive technopolymer body
- Big purge button
- Anti-scratch surface
- Bayonet-type cap holder with security lock
- Removable exhaust tee
- Weight without hose: 140 gr

COMBINATION PERFORMANCE

- Average Cracking effort 7.5 mbar
- Average breathing effort 1 J/l

Jacketed hose extremely light and flexible weight: 153 gr

Certification EN250/2014 for cold waters



1ST STAGE
MC9

2ND STAGE
COMPACT

LIGHTWEIGHT
REGULATOR SETS

CERTIFIED
EN 250/2014

This premiere travel regulator packs maximum performance into minimum space. A true featherweight second stage, the Compact is built from lightweight techno-polymers to eliminate jaw

fatigue. Easy to pack and easy to dive, the Compact includes dive/pre-dive Venturi switch for managing freeflow and maximizing performance at depth.



MC9 COMPACT INT MC9 COMPACT DIN



MC9 COMPACT INT MC9 COMPACT DIN

RESULTS:
INHALE, EXHALE PRESSURE AND EXT WORK OF BREATHING

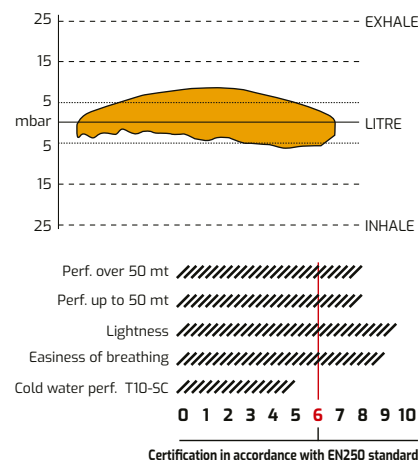

Set (INT) + Hose tot. weight	878 gr
Set (DIN) + Hose tot. weight	783 gr

TECHNICAL FEATURES 1ST STAGE

- Balanced diaphragm (seal chamber for MC95C)
- 2 outlets HP 7/16 UNF
- 4 outlets MP 3/8 UNF
- Service pressure: 300 bar (4350 psi) DIN version, 232 bar (3365 psi) Yoke version
- Calibration pressure: 10 Bar
- Brass body Electroless Nickel plated
- High capacity conical filter electroless nickel plated
- Aisi 316 removable nozzle
- Hyper-balancing
- Anti-pressure drop pneumatic spring
- Setting spring; stainless steel with micro opening treatment
- Cressi PressureSync system for a smoother inhalation pressure
- Elastomer protector
- Flow rate: 4500 l/min
- Yoke version weight: 590 gr
- Din version weight: 450 gr

TECHNICAL FEATURES 2ND STAGE

- Downstream system
- Adjustable Venturi effect
- Patented antifriction lever
- Big purge button
- Anti-scratch surface
- Bayonet-type cap holder with security lock
- Removable exhaust tee without tools
- Weight without hose: 135 gr

COMBINATION PERFORMANCE

- Average Cracking effort 6 mbar
- Average breathing effort 1 J/l

Jacketed hose extremely light and flexible weight: 153 gr

Certification EN250/2014 A>10° C



PRODUCT	CODE	RRP €
MC9/XS COMPACT REGULATOR INT	HX783051	279,99
MC9/XS COMPACT REGULATOR DIN	HX784051	279,99
MC9/XS COMPACT REGULATOR INT WHITE	HX783151	279,99
MC9/XS COMPACT REGULATOR DIN WHITE	HX784151	279,99

1ST STAGE
AC5

2ND STAGE
ZEN

NEW 2025

HIGH PERFORMANCE
REGULATOR

CERTIFIED
EN 250/2014

"ZEN is a state of calm attentiveness where actions are guided by intuition rather than by conscious effort."* This is our ZEN of diving—you become one with the water, calm, attentive, breathing in and out intuitively without effort. This regulator offers an ultra-lightweight and compact design to minimize jaw strain even during long dives. Paired with our AC5, a piston-controlled first stage, it represents simplicity, robustness, and reliability. Maintenance

is straightforward, fast, and cost-effective thanks to an ergonomic design that allows quick disassembly and reassembly without specialized tools, reducing downtime and maintenance costs. The ZEN/AC5 features an optimized design for maximum airflow and an extra large conical filter for improved filtration in both DIN and INT versions. Enlarged water passage slots ensure efficient rinsing, providing smooth, clean functionality and a true ZEN state of mind.

Set (INT) + Hose tot. weight *819 gr

Set (DIN) + Hose tot. weight *644 gr



AC5
INT REGULATOR



AC5
DIN REGULATOR

TECHNICAL FEATURES 1ST STAGE

- New piston 1st stage with INT or DIN 300bar connection.
- 4 L.P. ports, 1 HP port for optimal hose orientation.
- Direct external IP calibration system for precise pressure adjustment.
- IP calibration value: 9.5-10bar for consistent performance.
- New optimized 1st stage design for maximum flow.
- Conical filter for improved filtration in both versions.
- Single maintenance kit for both INT and DIN versions.
- Increased water passage slots for better pressure balance.
- Enlarged tool housing holes for easier servicing.
- CE EN250 certification pending for warm water use.
- Glossy finish with "Gun Metal" DIN wheel.
- Interchangeable parts with AC25 and AC2 models.
- Weight, INT version: 670g
- Weight, DIN version: 495g

TECHNICAL FEATURES 2ND STAGE

- Downstream system
- Adjustable Venturi effect
- Patented antifriction lever
- Dual-injection, enlarged purge button
- Radial pressure transmission openings
- Anti-scratch surface
- Bayonet-type cap holder with security lock
- Removable exhaust tee without tools
- Weight without hose: 149 gr

Jacketed hose extremely light and flexible
weight: 153 gr

Certification EN250/2014 A>10° C

PRODUCT	CODE		RRP €
AC5/ZEN REGULATOR INT RED	HX7900080		279.99
AC5/ZEN REGULATOR DIN RED	HX7900180		279.99





ZEN & ZEN PRO

f @ X J in v



COLD WATERS
CERTIFIED PRODUCT



WARM WATERS
CERTIFIED PRODUCT

**REVOLUTIONARY 2ND STAGE,
ULTRA LIGHT-WEIGHT AND COMPACT** <<

NEW 2025

STEFANO PEDEMONTE
Technical Manager Spearfishing Division



WHY BUY IT?

Compared to all the other second stages in the Cressi range, the Zen is more compact and lighter, which allows it to offer excellent performance.

WHAT MAKES IT DIFFERENT?

The Zen second stage has been studied and designed so that the special shape of the shell, which allows radial water inlets, avoids self-inflation due to swimming against the current

WHERE IS THE INNOVATION?

The soft purge button, made of two materials, makes the Zen much more ergonomic and immediate to use, without compromising abrasive resistance.

1ST STAGE
AC2

2ND STAGE
COMPACT

LIGHTWEIGHT
REGULATOR SETS

CERTIFIED
EN 250/2014



AC2 COMPACT INT

AC2 COMPACT DIN



TECHNICAL FEATURES 1ST STAGE

- Unbalanced piston
- 1 outlets HP 7/16 UNF
- 4 outlets MP 3/8 UNF
- Service pressure: 300 bar (4350 psi) DIN version, 232 bar (3365 psi) Yoke version
- Calibration pressure: 9.5-10 Bar
- Brass body Electroless Nickel plated
- High capacity conical filter electroless nickel plated
- Aisi 316 long lasting piston
- Easy external direct IP adjustment system
- Stainless steel spring
- Flow rate: 2100 l/min
- Yoke version weight: 635 gr
- Din version weight: 495 gr

TECHNICAL FEATURES 2ND STAGE

- Downstream system
- Adjustable Venturi effect
- Patented antifriction lever
- Big purge button
- Anti-scratch surface
- Bayonet-type cap holder with security lock
- Removable exhaust tee without tools
- Weight without hose: 135 gr

Jacketed hose extremely light and flexible weight: 153 gr

Certification EN250/2014 A>10° C



DIRECT IP ADJUSTMENT SYSTEM (NO SHIMS REQUIRED)

Set (INT) + Hose tot. weight 923 gr

Set (DIN) + Hose tot. weight 783 gr

PRODUCT	CODE	RRP €
AC2/COMPACT REGULATOR INT	HX787051	239,99
AC2/COMPACT REGULATOR DIN	HX788051	239,99

1ST STAGE
AC2

2ND STAGE
XS2

RELIABLE
DESIGN

CERTIFIED
EN 250/2014



TECHNICAL FEATURES 1ST STAGE

- Unbalanced piston
- 1 outlets HP 7/16 UNF
- 4 outlets MP 3/8 UNF
- Service pressure: 232 bar (3365 psi) Yoke version
- Calibration pressure: 9.5-10 Bar
- Brass body Electroless Nickel plated
- High capacity conical filter electroless nickel plated
- Aisi 316 long lasting piston
- Easy external direct IP adjustment system
- Stainless steel spring
- Flow rate: 2100 l/min
- Yoke version weight: 635 gr

TECHNICAL FEATURES 2ND STAGE

- Downstream system
- Adjustable Venturi effect
- Easy maintenance
- Weight without hose: 206 gr

Jacketed hose extremely light and flexible weight: 153 gr

Certification EN250/2014 A>10° C



DIRECT IP ADJUSTMENT SYSTEM (NO SHIMS REQUIRED)

Set (INT) + Hose tot. weight 994 gr

PRODUCT	CODE	RRP €
AC2/XS2 REGULATOR INT	HX780000	249,99

1ST STAGE
MC9

2ND STAGE
COMPACT

OCTOPUS
COMPACT

LIGHTWEIGHT
REGULATOR SETS

CERTIFIED
EN 250/2014



TECHNICAL FEATURES 1ST STAGE

- Balanced diaphragm (seal chamber for MC95C)
- 2 outlets HP 7/16 UNF
- 4 outlets MP 3/8 UNF
- Service pressure: 300 bar (4350 psi) DIN version, 232 bar (3365 psi) Yoke version
- Calibration pressure: 10 Bar
- Brass body Electroless Nickel plated
- High capacity conical filter electroless nickel plated
- Aisi 316 removable nozzle
- Hyper-balancing
- Anti-pressure drop pneumatic spring
- Setting spring: stainless steel with micro opening treatment
- Cressi PressureSync system for a smoother inhalation pressure
- Elastomer protector
- Flow rate: 4500 l/min
- Yoke version weight: 590 gr
- Din version weight: 450 gr

TECHNICAL FEATURES 2ND STAGE

- Downstream system
- Adjustable Venturi effect
- Patented antifriction lever
- Big purge button
- Anti-scratch surface
- Bayonet-type cap holder with security lock
- Removable exhaust tee without tools
- Weight without hose: 135 gr

Jacketed hose extremely light and flexible weight: 153 gr

Certification EN250/2014 A>10° C



MC9 COMPACT INT



MC9 COMPACT DIN



DIRECT IP ADJUSTMENT SYSTEM (NO SHIMS REQUIRED)



PRODUCT	CODE	RRP €
MC9/COMPACT + OCTOPUS COMPACT REGULATOR INT	WHY783051	379.99
MC9/COMPACT + OCTOPUS COMPACT REGULATOR DIN	WHY784051	379.99



1ST STAGE
AC5

2ND STAGE
ZEN

**OCTOPUS
ZEN**

NEW 2025

LIGHTWEIGHT
REGULATOR SETS

CERTIFIED
EN 250/2014



TECHNICAL FEATURES 1ST STAGE

- New piston 1st stage with INT or DIN 300bar connection.
- 4 L.P. ports, 1 HP port for optimal hose orientation.
- Direct external IP calibration system for precise pressure adjustment.
- IP calibration value: 9.5-10bar for consistent performance.
- New optimized 1st stage design for maximum flow.
- Conical filter for improved filtration in both versions.
- Single maintenance kit for both INT and DIN versions.
- Increased water passage slots for better pressure balance.
- Enlarged tool housing holes for easier servicing.
- CE EN250 certification pending for warm water use.
- Glossy finish with "Gun Metal" DIN wheel.
- Interchangeable parts with AC25 and AC2 models.
- Weight, INT version: 670g
- Weight, DIN version: 495g

TECHNICAL FEATURES 2ND STAGE

- Downstream system
- Adjustable Venturi effect
- Patented antifricition lever
- Dual-injection, enlarged purge button
- Radial pressure transmission openings
- Anti-scratch surface
- Bayonet-type cap holder with security lock
- Removable exhaust tee without tools
- Weight without hose: 149 gr



AC5
INT REGULATOR

AC5
DIN REGULATOR

PRODUCT	CODE	RRP €
AC5/ZEN RED + ZEN OCTOPUS REGULATOR INT	WHY790280	369,99
AC5/ZEN RED + ZEN OCTOPUS REGULATOR DIN	WHY790180	369,99



1ST STAGE
AC2

2ND STAGE
COMPACT

OCTOPUS
COMPACT

LIGHTWEIGHT
REGULATOR SETS

CERTIFIED
EN 250/2014



AC2 COMPACT INT



AC2 COMPACT DIN

TECHNICAL FEATURES 1ST STAGE

- Unbalanced piston
- 1 outlets HP 7/16 UNF
- 4 outlets MP 3/8 UNF
- Service pressure: 300 bar (4350 psi) DIN version, 232 bar (3365 psi) Yoke version
- Calibration pressure: 9.5-10 Bar
- Brass body Electroless Nickel plated
- High capacity conical filter electroless nickel plated
- Aisi 316 long lasting piston
- Easy external direct IP adjustment system
- Stainless steel spring
- Flow rate: 2100 l/min
- Yoke version weight: 635 gr
- Din version weight: 495 gr

TECHNICAL FEATURES 2ND STAGE

- Downstream system
- Adjustable Venturi effect
- Patented antifriction lever
- Big purge button
- Anti-scratch surface
- Bayonet-type cap holder with security lock
- Removable exhaust tee without tools
- Weight without hose: 135 gr

Jacketed hose extremely light and flexible weight: 153 gr

Certification EN250/2014 A>10° C



DIRECT IP ADJUSTMENT SYSTEM (NO SHIMS REQUIRED)



PRODUCT	CODE		RRP €
AC2 COMPACT+OCTOPUS COMPACT REGULATOR INT	HY787051		349.99
AC2 COMPACT+OCTOPUS COMPACT REGULATOR DIN	HY788051		349.99





MG BALANCED



NATURAL AND EFFORTLESS BREATHING

PNEUMATICALLY BALANCED VALVE

CERTIFIED EN 250/2014 FOR COLD WATERS

OCTOPUS

Octopus regulator specially designed for the most demanding divers. Its main feature is a pneumatically balanced valve that minimises the breathing effort. The Venturi effect adjuster on the mouthpiece tube increases and decreases the air flow, doing away with the risks associated with

free-flow. When scuba diving, breathing is natural and effortless. Thanks to its light weight and ergonomic design, this regulator is very handy and easy to use. Weight without the whip: 182 g.



TECHNICAL FEATURES

- Pneumatically balanced
- Venturi effect adjustment
- Patented elliptical membrane
- Patented low-friction lever
- Air delivery system without injector
- Internal heat exchange
- Cam-lock system to open the case
- Body in noise-absorbent technopolymer
- Removable technopolymer deflector
- Removable mechanical parts
- Weight without whip: 182 gr

Jacketed hose extremely light and flexible weight: 153 gr

Certification Annex B EN 250:2014 for cold water



PRODUCT	CODE	RRP €
OCTOPUS MG BALANCED REGULATOR	HX880000	179.99

ZEN



NEW 2025



NATURAL AND EFFORTLESS BREATHING

CERTIFIED EN 250/2014

OCTOPUS

"ZEN is a state of calm attentiveness where actions are guided by intuition rather than by conscious effort."* This is our ZEN of diving—you become one with the water, calm, attentive, breathing in and out intuitively without any conscious effort. This regulator offers an ultra-lightweight and compact design to minimize jaw strain even during extended dives. The purge button, constructed with dual-injection molding, provides exceptional durability and longevity. It features radial openings on the

front cover, specifically designed to avoid any free-flows even when diving against strong currents. Maintenance is simple, fast, and inexpensive thanks to an ergonomically engineered design that allows quick disassembly and reassembly without specialized tools, reducing downtime and maintenance costs.



TECHNICAL FEATURES

- Downstream system
- Adjustable Venturi effect
- Patented antifriction lever
- Dual-injection, enlarged purge button
- Radial pressure transmission openings
- Anti-scratch surface
- Bayonet-type cap holder with security lock
- Removable exhaust tee without tools
- Weight without hose: 149 gr



PRODUCT	CODE	RRP €
ZEN OCTOPUS REGULATOR	HX790200	109.99

COMPACT PRO

OCTOPUS

An ideal second stage for use as a safe second, the Compact delivers big-regulator performance in a small, easily stowed package. It's unique shape make it easy to purge and deploy quickly.



PRODUCT	CODE	RRP €
OCTOPUS COMPACT PRO REGULATOR	HX789500	129.99

QUICK AND EASY DEPLOYMENT

CERTIFIED EN 250/2014 FOR COLD WATERS

TECHNICAL FEATURES

- Downstream system
- Adjustable Venturi effect
- Patented antifriction lever
- Thermoconductive technopolymer body
- Big purge button
- Anti-scratch surface
- Bayonet-type cap holder with security lock
- Removable exhaust tee without tools
- Weight without hose: 140 gr

Jacketed hose extremely light and flexible weight: 153 gr

Certification Annex B EN 250:2014 for cold water



COMPACT

OCTOPUS

An ideal second stage for use as a safe second, the Compact delivers big-regulator performance in a small, easily stowed package. It's unique shape make it easy to purge and deploy quickly.



PRODUCT	CODE	RRP €
OCTOPUS COMPACT REGULATOR	HX789000	104.99



ALSO FOR RENTAL



MADE IN ITALY

QUICK AND EASY DEPLOYMENT

CERTIFIED EN 250/2014

TECHNICAL FEATURES

- Downstream system
- Adjustable Venturi effect
- Patented antifriction lever
- Big purge button
- Anti-scratch surface
- Bayonet-type cap holder with security lock
- Removable exhaust tee without tools
- Weight without hose :135 gr

Jacketed hose extremely light and flexible weight: 153 gr

Certification Annex B EN 250:2014_ A>10°C



XS2

OCTOPUS

ULTRA RELIABLE DESIGN | CERTIFIED EN 250/2014

Proven and highly affordable, the XS Octopus is ideal for any diver looking for maximum value. Its low maintenance and ultra reliable design also make it a favorite among dive schools and rental centers.



TECHNICAL FEATURES

- Downstream system
- Adjustable Venturi effect
- Easy maintenance
- Weight without hose: 206 gr

Jacketed hose extremely light and flexible weight: 153 gr

Certification Annex B EN 250:2014_ A>10°C



PRODUCT	CODE		RRP €
OCTOPUS XS REGULATOR	HX770098		124,99



Photo by: Voyages of Agape



WE MANUFACTURE
QUALITY
SINCE 1946

1st
STAGES



COLD WATERS
CERTIFIED PRODUCT



WARM WATERS
CERTIFIED PRODUCT



WARM WATERS
CERTIFIED PRODUCT



ULTRA
COMPACT



SHOCKPROOF
PROTECTION



EASE OF
MAINTAINANCE



LOW-FRICTION
VALVE



SMOOTHER
BREATHING



ELASTOMER
PROTECTION



INTERSTAGE PRESSURE
ADJUSTMENT



OPTIMIZED
WATER DRAINAGE



EASE OF
MAINTAINANCE

/ REGULATORS

T10 SC *



VERSION	CODE	RRP €
INT	HZ991008	309,99
DIN	HZ991009	309,99

DESCRIPTION:
Hyperbalanced T shape diaphragm 1st stage with seal chamber system, PVD finishing.

*See compatibility warnings!

T10 SC CROMO *



VERSION	CODE	RRP €
INT	HZ991006	289,99
DIN	HZ991007	289,99

DESCRIPTION:
Hyperbalanced T shape diaphragm 1st stage with seal chamber system, chrome finishing.

*See compatibility warnings!

MC11 SC* NEW 2025



VERSION	CODE	RRP €
INT	HZ820110	219,99
DIN	HZ820111	219,99

DESCRIPTION:
The MC11SC first stage unlocks your next level of diving: You can dive deeper, colder, more streamlined. This first stage is a dry sealed, cold-water suitable hyperbalanced diaphragm system, power-packed into an ultra-compact size. SC stands for sealed chamber and only adds 30grams to the standart, warm water MC11, but additionally keeps its working components dry and clean, preserving lubrication and protecting them from corrosion, while the shockproof technopolymer protection helps to maintain this first stage to look "like new" for many years of diving. .

*See compatibility warnings!

MC11 * NEW 2025



VERSION	CODE	RRP €
INT	HZ820100	209,99
DIN	HZ820101	209,99

DESCRIPTION:
The MC11 first stage is a hyperbalanced diaphragm system, power-packed into an ultra-compact size, ready for your global underwater explorations. The MC11 stands out in the global regulator market by using our proprietary Cressi PressureSync System, a Cressi innovation that drastically reduces the typical drop in working pressure at the beginning of the inhaling phase. Due to the Cressi PressureSync System, your entire inhalation phase will be even and fully supported by 100% of the working pressure - during every breath you take. With a total weight of only 422 g (DIN) and 569 g (INT), the MC11 is the ideal travel companion for any warm water diver. With two high-pressure ports, it also offers extra safety by allowing a redundant pressure gauge.

*See compatibility warnings!

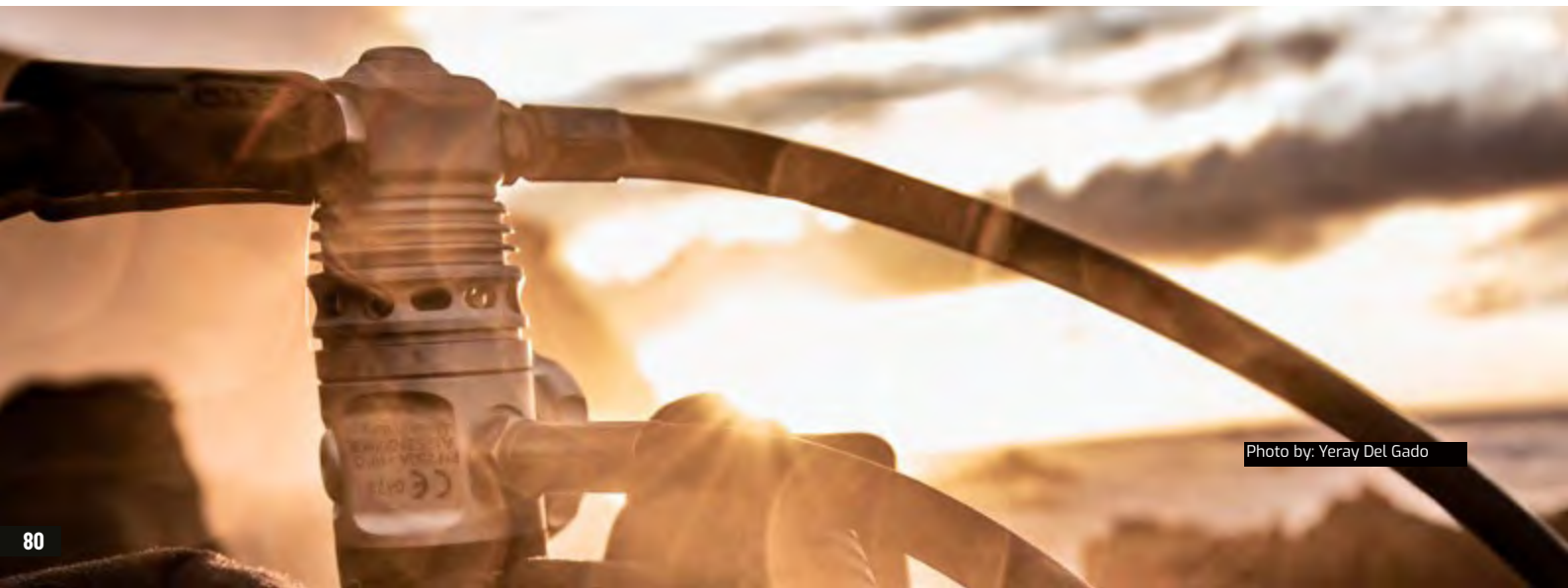

Photo by: Yeray Del Gado

/ REGULATORS

MC9 SC *



VERSION	CODE		RRP €
INT	HZ820095		209,99
DIN	HZ820096		209,99

DESCRIPTION:
Hyperbalanced in-line shape diaphragm 1st stage with seal chamber system.

*See compatibility warnings!

MC9 *



VERSION	CODE		RRP €
INT	HZ820097		199,99
DIN	HZ820098		199,99

DESCRIPTION:
Hyperbalanced in-line shape diaphragm 1st stage; external IP direct adjustment system.

*See compatibility warnings!

AC25m *



VERSION	CODE		RRP €
INT	HZ900003		349,99
DIN	HZ900004		349,99

DESCRIPTION:
Revolving turret balanced piston 1st stage, gun-metal chrome finishing, external IP direct adjustment system.

*See compatibility warnings!

AC5 *

NEW 2025



VERSION	CODE		RRP €
INT	HZ992000		149,99
DIN	HZ992100		149,99

DESCRIPTION:
The AC5 is a piston-controlled first stage that represents the workhorse of the diving industry: simple, robust, reliable! At Cressi, all piston first stages feature our proprietary external direct adjustment system, reducing the regular need for replacement parts or shims, thus minimizing service costs over many years. The AC5 boasts an optimized design for maximum flow and a conical filter for improved filtration in both versions, DIN or INT. Enlarged water passage slots allow for perfectly efficient rinsing, better pressure balance, and enlarged tool housing holes for easy maintenance.

*See compatibility warnings!

AC2 *



VERSION	CODE		RRP €
INT	HZ991001		139,99
DIN	HZ780098		139,99

DESCRIPTION:
Unbalanced piston 1st stage, external IP direct adjustment system.

*See compatibility warnings!

LONG SAFEFLEX HOSES *



LENGHT	CODE		RRP €
150 CM	HZ730231		49,99
210 CM	HZ730232		69,99

DESCRIPTION:
Replacement hoses for regulators

*See compatibility warnings!



/ REGULATORS COMPARISON TABLE

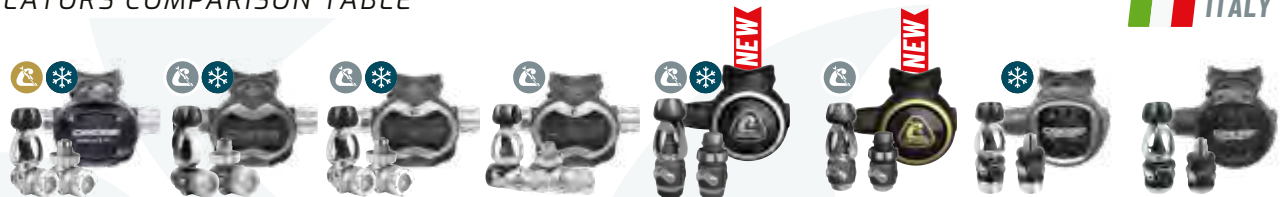

1st STAGE	T10 SC CROMO	T10 SC PVD	T10 SC CROMO	AC25M	MC11 SC	MC11	MC9 SC	MC9
2nd STAGE	GALAXY ADJUSTABLE	MASTER	MASTER CROMO	MASTER CROMO	ZEN PRO	ZEN	COMPACT PRO	COMPACT
Set (INT) + Hose total weight	1075 gr	1080 gr	1080 gr	1170gr	897 gr	861 gr	943 gr	878 gr
Set (DIN) + Hose total weight	957 gr	962 gr	962 gr	1054gr	750 gr	714 gr	803 gr	783 gr
CERTIFIED EN 250/2014	Cold Water (A)	Cold Water (A)	Cold Water (A)	Warm Water (A > 10°C)	Cold Water (A)	Warm Water > 10°C	Cold Water (A)	Warm Water (A > 10°C)

Technical Features 1st stage

Technology	"T" shape Hyperbalanced diaphragm 1st stage with Watertight "Seal chamber" system	"T" shape Hyperbalanced diaphragm 1st stage with Watertight "Seal chamber" system	"T" shape Hyperbalanced diaphragm 1st stage with Watertight "Seal chamber" system	3rd generation Cressi's Revolving Turret Balanced Piston first stage w/ direct IP external control system and 5th co-axial LP port	Hyperbalanced in-line diaphragm 1st stage with Watertight "Seal chamber" system	Hyperbalanced in-line diaphragm 1st stage	Hyperbalanced in-line diaphragm 1st stage with Watertight "Seal chamber" system	Hyperbalanced in-line diaphragm 1st stage
PORTS	*2x HP 7/16 UNF 4x MP 3/8 UNF"	*2x HP 7/16 UNF 4x MP 3/8 UNF"	*2x HP 7/16 UNF 4x MP 3/8 UNF"	*2x HP 7/16 UNF 5x LP 3/8 UNF (1xCo-axial HI FLOW port on turret top)"	*2x HP 7/16 UNF 4x MP 3/8 UNF"	*2x HP 7/16 UNF 4x MP 3/8 UNF"	*2x HP 7/16 UNF 4x MP 3/8 UNF"	*2x HP 7/16 UNF 4x MP 3/8 UNF"
MAX OPERATING PRESSURE	"DIN: 300 bar (4350 psi) INT: 232 bar (3365 psi)"	"DIN: 300 bar (4350 psi) INT: 232 bar (3365 psi)"	"DIN: 300 bar (4350 psi) INT: 232 bar (3365 psi)"	"DIN: 300 bar (4351 psi) INT: 230 bar (3336 psi)"	"DIN: 300 bar (4350 psi) INT: 232 bar (3365 psi)"	"DIN: 300 bar (4350 psi) INT: 232 bar (3365 psi)"	"DIN: 300 bar (4350 psi) INT: 232 bar (3365 psi)"	"DIN: 300 bar (4350 psi) INT: 232 bar (3365 psi)"
IP CALIBRATION PRESSURE	9.5 -10 bar	9.5 -10 bar	9.5 -10 bar	9.5 -10 bar	9.5 -10 bar	9.5 -10 bar	9.5 -10 bar	9.5 -10 bar
FILTER Design	High-capacity conical filter in chemically nickel-plated spherical bronze	High-capacity conical filter in chemically nickel-plated spherical bronze	High-capacity conical filter in chemically nickel-plated spherical bronze	High-capacity conical filter in chemically nickel-plated spherical bronze	High capacity conical filter electroless nickel plated	High capacity conical filter electroless nickel plated	High capacity conical filter electroless nickel plated	High capacity conical filter electroless nickel plated
FLOW RATE	4500 l/min	4500 l/min	4500 l/min	3800l/min	4500 l/min	4500 l/min	4500 l/min	4500 l/min
WEIGHT without Hose	"DIN: 602 gr INT: 720 gr"	"DIN: 602 gr INT: 720 gr"	"DIN: 602 gr INT: 720 gr"	"DIN: 694 gr INT: 814 gr"	"DIN: 458 gr INT: 603 gr"	"DIN: 422 gr INT: 569 gr"	"DIN: 510 gr INT: 650 gr"	"DIN: 450 gr INT: 590 gr"
1st stage Coating protection	Chemical Chromed Coating protection	Chemical Chromed Coating protection	Chemical Chromed Coating protection	"Gun Metal" Chemical Chromed Coating protection	Chemical Chromed Coating protection w/ body Elastomer Protector	Chemical Chromed Coating protection w/ body Elastomer Protector	Chemical Chromed Coating protection w/ body Elastomer Protector	Chemical Chromed Coating protection w/ body Elastomer Protector
MAINTENANCE KITS	1st STAGE HZ800045 2nd STAGE HZ820080	1st STAGE HZ800045 2nd STAGE HZ820080	1st STAGE HZ800045 2nd STAGE HZ820080	1st STAGE HZ850017 2nd STAGE HZ820080	1st STAGE HZ820200 2nd STAGE HZ780060	1st STAGE HZ820200 2nd STAGE HZ780060	1st STAGE HZ800047 2nd STAGE HZ780060	1st STAGE HZ800047 2nd STAGE HZ780060

Technical Features 2st stage

Technology	Pneumatically balanced	Pneumatically balanced	Pneumatically balanced	Pneumatically balanced	Standard Downstream	Standard Downstream	Standard Downstream	Standard Downstream
ADJUSTABLE VENTURI Control System	Yes	Yes	Yes	Yes	Yes	Yes	Yes	Yes
DIAPHRAGM Design	Patented Elliptical Diaphragm with comolded Antifriction plate	Patented Elliptical Diaphragm with comolded Antifriction plate	Patented Elliptical Diaphragm with comolded Antifriction plate	Patented Elliptical Diaphragm with comolded Antifriction plate	Circular with comolded antifriction plate	Circular with comolded antifriction plate	Circular with comolded antifriction plate	Circular with comolded antifriction plate
LEVER Design	Patented Reduced Friction Design Lever	Patented Reduced Friction Design Lever	Patented Reduced Friction Design Lever	Patented Reduced Friction Design Lever	Patented Reduced Friction Design Lever	Patented Reduced Friction Design Lever	Patented Reduced Friction Design Lever	Patented Reduced Friction Design Lever
HEATER EXCHANGER SYSTEM	Internal Heater Exchanger System	Internal Heater Exchanger System	Internal Heater Exchanger System	Internal Heater Exchanger System	No	No	No	No
WEIGHT without Hose	202 gr	207 gr	207 gr	207 gr	149 gr	149 gr	140 gr	135 gr

Combination Performance

EN 250 Average Cracking inhalation Effort	3.5 mbar	3.5 mbar	3.5 mbar	4,5 mbar	5 mbar	5 mbar	5 mbar	6 mbar
EN 250 WOB	0.6 J/l	0.6 J/l	0.6 J/l	0.7 J/l	1 J/l	1 J/l	1 J/l	1 J/l
Elite Case Included	Yes	Yes	Yes	Yes	Yes	Yes	Yes	No
Hose Included	Yes	Yes	Yes	Yes	Yes	Yes	Yes	Yes
Hose Feature	Cressi Safeflex Jacketed hose extremely light and flexible	Cressi Safeflex Jacketed hose extremely light and flexible	Cressi Safeflex Jacketed hose extremely light and flexible	Cressi Safeflex Jacketed hose extremely light and flexible	Thermoplastics Jacketed hose extremely light and flexible	Thermoplastics Jacketed hose extremely light and flexible	Cressi Safeflex Jacketed hose extremely light and flexible	Thermoplastics Jacketed hose extremely light and flexible
Hose Weight	153 g	153 g	153 g	153 g	153 g	153 g	153 g	153 g

/ REGULATORS COMPARISON TABLE



1st STAGE	AC5	AC2	AC2
2nd STAGE	ZEN	COMPACT	X52
Set (INT) + Hose total weight	880 gr	923 gr	994 gr
Set (DIN) + Hose total weight	720 gr	783 gr	-
CERTIFIED EN 250/2014	Warm Water (A > 10°C)	Warm Water (A > 10°C)	Warm Water (A > 10°C)
Technical Features 1st stage			
Technology	Unbalanced piston with external direct IP adj control system	Unbalanced piston	Unbalanced piston
PORTS	"1 HP 7/16 UNF 4 JP 3/8 UNF"	"1 HP 7/16 UNF 4 MP 3/8 UNF"	"1 HP 7/16 UNF 4 MP 3/8 UNF"
MAX OPERATING PRESSURE	"DIN: 300 bar (4350 psi) INT: 232 bar (3365 psi)"	"DIN: 300 bar (4350 psi) INT: 232 bar (3365 psi)"	INT: 232 bar (3365 psi)
IP CALIBRATION PRESSURE	9.5 -10 bar	9.5 -10 bar	9.5 -10 bar
FILTER Design	High-capacity conical filter in chemically nickelplated spherical bronze	High capacity conical filter electroless nickel plated	High capacity conical filter electroless nickel plated
FLOW RATE	-	2100 l/min	2100 l/min
WEIGHT without Hose	"DIN: 435 gr INT: 600 gr"	"DIN: 495 gr INT: 635 gr"	INT: 635 gr
1st stage Coating protection	Chemical Chromed Coating protection and "Gun Metal" DIN Connection)	Chemical Chromed Coating protection	Chemical Chromed Coating protection
MAINTENANCE KITS	1st STAGE HZ892400 2nd STAGE HZ780060	1st STAGE NT: HZ730150 DIN: HZ730149 2nd STAGE HZ780060	1st STAGE HZ730150 2nd STAGE HZ790090

Technical Features 2st stage			
Tecnology	Standard Downstream	Standard Downstream	Standard Downstream
ADJUSTABLE VENTURI Control System	Yes	Yes	Yes
DIAPHRAGM Design	Circular with co-molded antifriction plate	Circular with co-molded antifriction plate	Circular with metal plate
LEVER Design	Patented Reduced Friction Design Lever	Patented Reduced Friction Design Lever	Standard design
HEATER EXCHANGER System	No	No	No
WEIGHT without Hose	149 gr	135 gr	206 gr

Combination Performance			
EN 250 Average Cracking inhalation Effort	6 mbar	6 mbar	9mbar
EN 250 WOB	1 J/l	1 J/l	1.5 J/l
Elite Case Included	No	No	No
Hose Included	Yes	Yes	Yes
Hose Feature	Thermoplastics Jacketed hose extremely light and flexible	Thermoplastics Jacketed hose extremely light and flexible	Thermoplastics Jacketed hose extremely light and flexible
Hose Weight	153 g	153 g	153 g

*** COMPATIBILITY WARNINGS !**

The 1st stages and hoses are sold ONLY as a replacement for the regulator combination for which its use is envisaged under the regulatory requirements in force. Therefore it may only be used as a replacement for the combination with second stages called for in the EC certificate for the type that concern it as well as the EC declaration of conformity for the product according to Regulation (EU) 2016/425, which can be viewed at www.cressi.com. Cressi Sub declines all responsibility for any other use that does not conform with the requirements dictated by the regulations in force. The combinations of the certified Cressi regulators are contained in the last page of the Regulator user manual which can be read or downloaded from www.cressi.com using the following QR Code:



Photo by: Wojciech Dopierala

MAIN REGULATORS SPARE PARTS

NEW SIZES 2025



REGULATORS SPARE PARTS	CODE		RRP €
T10/T10 SC CROMO ANNUAL SERVICE KIT	HZ800045		-
ANNUAL SERVICE KIT AC25g/AC25m	HZ850017		-
MC9-MC9 SC INT/DIN ANNUAL SERVICE KIT	HZ800047		-
MAINTENANCE KIT 1st STAGE AC5 INT/DIN	HZ892400		-
MC11/MC11 SC 1ST STAGE INT/DIN ANNUAL SERVICE KIT	HZ820200		-
AC2 INT ANNUAL SERVICE KIT	HZ730150		-
AC2 DIN 300 ANNUAL SERVICE KIT	HZ730149		-
ANNUAL SERVICE KIT 2nd STAGE COMPACT/COMPACT PRO/ZEN/ZEN PRO	HZ780060		-
ANNUAL SERVICE KIT 2nd STAGE MASTER/GALAXY	HZ820080		-
MAINTEN.KIT 2NDSTAGE ELLIPSE TIT./STEEL/BLACK/OCTOPUS	HZ810067		-
ANNUAL SERVICE KIT 2nd STAGE X52	HZ790090		-
LP BLACK HOSE 80 cm	HZ730222		39,99
LP YELLOW HOSE 100 cm	HZ730225		44,99
COVER PURGE BUTTON BLACK	HZ780067		12,5
COVER PURGE BUTTON WHITE	HZ780064		12,5
SILICONE MOUTHPIECE 2 TONE BLACK/YELLOW	HZ790351		10,99
SILICONE MOUTHPIECE 2 TONE BLACK/GREY	HZ790357		10,99
COMFOBITE STANDARD CLEAR	HZ790400		10,99
COMFOBITE STANDARD BLACK	HZ790450		10,99

REGULATORS TOOLS	CODE		RRP €
1st STAGE SETTING PRESSURE GAUGE	HZ710010		-
THREADED BAR TO TIGHTEN THE REGULATOR IN THE GRIP	HZ709008		-
PIN SPANNER	HZ739003		-

REGULATORS ACCESSORIES	CODE		RRP €
MAGNETIC OCTOPUS HOLDER	TA700002		39,99
SILICONE OCTOPUS HOLDER	HZ702010		9,99

REGS SPECIFIC SERVICE COMPLETE KIT BAG

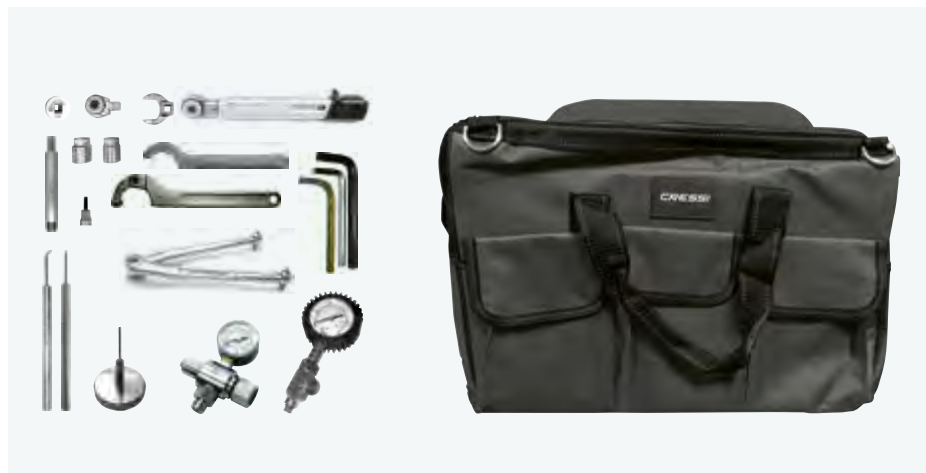

REGULATORS TOOLS 1ST STAGE
 full set dynamometric wrench
 + 1st stage ip setting gauge
 + threaded bar to tighten the regulator in the vice
 + yoke nut removing socket and wrench
 + allen key 6 mm
 + allen key 7 mm
 + extraction pointtool
 + tool to remove o-rings
 + big compass s.c. spanner
 + antifreeze/s.c. spanner
 + push tool
 + ogival tool o-ring bullit
 + pin spanner
 + universal push tool
 + ac2/ac5 ip adjusting tool
 + removing hp seat ac2/ac5
 + pin punch 110 mm 2

REGULATORS TOOLS 2ND STAGE
 5,5 mm socket driver
 + spring push tool
 + allen key 4 mm
 + allen key 6 mm
 + o-ring removal tool
 + 2nd stage inline adjuster with ip gauge
 + 2nd stage setting gauge
 + small compass spanner
 + extraction plier

JACKETS TOOLS
 12 mm socket wrench
 + extraction point tool
 + compass spanner
 + allen key 2,5 mm
 + allen key 6 mm

PRODUCT	CODE		RRP €
SERVICE AND REPAIR COMPLETE KIT	HZ830102		-

TEST GAUGE ARA BAR/PSI



PRODUCT	CODE	RRP €
INT	KK760000	69.99
DIN	KK760600	69.99

DESCRIPTION:

External (non-watertight) pressure gauge for checking cylinder pressure out of water. It has a bracket attachment int. Bleeder screw has large, easy-to-grip knob. Easy-to-read dial with full scale at 315 bar

STANDARD TOOLS



CODE	RRP €
HZ710001	-

DESCRIPTION:

Standard tools set for maintenance Cressi regulators

DYNAMOMETRIC WRENCH



CODE	RRP €
HZ709021	-

DESCRIPTION:

Dynamometric wrench + full set of accessories

COMB. WRENCHES



NEW SIZES 2025

MM	CODE	RRP €
30	HZ709044	-
36	HZ709046	-
25	HZ709047	-
24	HZ709043	-
22	HZ709042	-
19	HZ709041	-
17	HZ709040	-

MOBILE TEST BENCH



CODE	RRP €
HZ709030	-

DESCRIPTION:

Cressi regulator mobile test bench

NEOPRENE PAD



CODE	RRP €
HZ710003	-

DESCRIPTION:

Neoprene pad for regulators maintenance

SPARE PARTS CATALOGUE



CODE	RRP €
VPPART00	-

DESCRIPTION:

Service and repair operative manual

TECHNICAL SCHEME POSTERS



REGULATORS SPARE PARTS	CODE	RRP €
T10 SC CROMO MASTER CROMO	VPOSTERTMC	9.99
T10 SC MASTER	VPOSTERTM	9.99
T10 SC CROMO GALAXY ADJUSTABLE R	VPOSTERTGR	9.99





B.C.D.'S

Photo by: James Muir

B.C.D.'S

BUOYANCY
27LBS
12KG



PLUS



AQUA SERIES

BUOYANCY
38LBS
17KG



MAX



BUOYANCY
27LBS
12KG



AQUAWING MAX

SPECIALIZED
Retailer-Product

ANODISED LIGHT ALLOY BACK PLATE | NYLON 210 D AIR BLADDER
MODULAR ADJUSTMENT SYSTEM | EQUIPPED WITH WEIGHT POCKETS

HIGH BUOYANCY + ONE SIZE FITS ALL + WEIGHT POCKETS

Aquawing Max is the one-size donut jacket designed to adapt to all anatomies (male and female) using the new patented mas (modular adjustment system): the single 50 mm belt that embraces the shoulders and waist can be rapidly adjusted to your size. The bag's profile is designed to ensure perfect buoyancy with a single tank, and the increased volume generates a buoyancy of 170 N, making the Jacket particularly suitable for dives with increased ballast, such as in cold water to compensate for the high thickness of wetsuits. The anodised light alloy back plate reduces the overall weight of the jacket while guaranteeing

stability and safety in use. The special cylinder rest in thermoplastic rubber integrated with the back of the jacket guarantees the positioning of the tank for optimum trim. The shoulder straps and back cover are made with an air-net material to enhance comfort and improve water drainage. The jacket is equipped with two weight pockets attached directly to the back plate in correspondence with your flanks. The back cover is equipped with a special pocket designed to house the decompression buoy.

TECHNICAL FEATURES

- One-size-fits-all (XS / XL)
- Light and stable
- MAS (Modular Adjustment System)
- Extra back weight 2.5kg

BUOYANCY

SIZE	NEWTON	KG	POUNDS
XS-XL	170	17.33	38.21

PRODUCT WEIGHT

SIZE	KG	LBS
XS-XL	3.9	8.6



PRODUCT	CODE	RRP €
AQUAWING MAX BCD XS/XL	IC790200	699,99
BACK WEIGHT BAR 2.5 KG	IZ790400	79,99

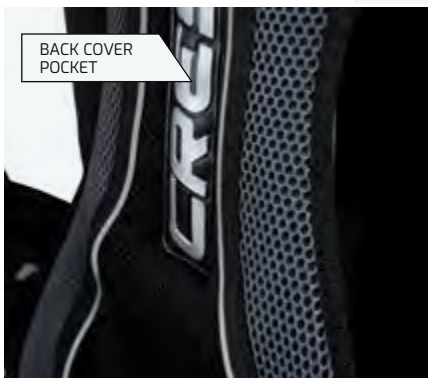

AQUAWING PLUS SPECIALIZED

NEW COLORS 2025

ANODISED LIGHT ALLOY BACK PLATE | NYLON 210 D AIR BLADDER
MODULAR ADJUSTMENT SYSTEM | EQUIPPED WITH WEIGHT POCKETS

ONE SIZE FITS ALL + WEIGHT POCKETS

Aquawing Plus is the one-size donut jacket designed to adapt to all anatomies (male and female) using the new patented MAS (MAS (Modular Adjustment System): in fact, the single 50 mm belt that embraces the shoulders and waist can be rapidly adjusted to your size. The shape of the air bladder has been designed to ensure perfect buoyancy with a monocylinder. The anodised light alloy back plate reduces the overall weight of the jacket while guaranteeing stability and safety in use. The special cylinder rest in thermoplastic rubber integrated with the back

of the jacket guarantees the positioning of the tank for optimum trim. The shoulder straps and back cover are made with an air-net material to enhance comfort and improve water drainage. The jacket is equipped with two weight pockets attached directly to the back plate in correspondence with your flanks. The back cover is equipped with a special pocket designed to house the decompression buoy.

TECHNICAL FEATURES

- One-size-fits-all (XS / XL)
- Air bladder: 210 D nylon
- Air bladder cover: 1500 D cordura
- MAS (Modular Adjustment System)
- 4 Stainless steel D-ring

BUOYANCY

SIZE	NEWTON	KG	POUNDS
XS-XL	120	12,2	26,9

PRODUCT WEIGHT

SIZE	KG	LBS
XS-XL	3,75	8,26



PRODUCT	BLUE	BLACK	RED		RRP €
AQUAWING PLUS BCD XS/XL	IC79010	IC790150	IC790180		649,99
BACK WEIGHT BAR 2.5 KG	IZ790400	IZ790400	IZ790400		79,99





ANODISED LIGHT ALLOY BACK PLATE

NYLON 210 D AIR BLADDER

MODULAR ADJUSTMENT SYSTEM

AQUAWING

ONE SIZE FITS ALL

Aquawing is the one-size donut jacket designed to adapt to all anatomies (male and female) using the new patented MAS (MAS (Modular Adjustment System): in fact, the single 50 mm belt that embraces the shoulders and waist can be rapidly adjusted to your size.

The shape of the air bladder has been designed to ensure perfect buoyancy with a monocyliner. The anodised light alloy back plate reduces the overall weight of the jacket while guaranteeing

stability and safety in use. The special cylinder rest in thermoplastic rubber integrated with the back of the jacket guarantees the positioning of the tank for optimum trim.

The shoulder straps and back cover are made with an air-net material to enhance comfort and improve water drainage.

The back cover is equipped with a special pocket designed to house the decompression buoy.

TECHNICAL FEATURES

- One-size-fits-all (XS / XL)
- Air bladder: 210 D nylon
- Air bladder cover: 1500 D cordura
- MAS (Modular Adjustment System)
- 2 Stainless steel D-ring + 1 optional

BUOYANCY

SIZE	NEWTON	KG	POUNDS
XS-XL	120	12,2	26,9

PRODUCT WEIGHT

SIZE	KG	LBS
XS-XL	2,9	6,39

BUOYANCY
27LBS
12KG

ANODISED LIGHT ALLOY BACK PLATE

MODULAR ADJUSTMENT SYSTEM



OPTIONAL BACK WEIGHT 2.5 KG BAR



PATENTED MODULAR ADJUSTMENT SYSTEM
The single belt that embraces the shoulders and waist can be rapidly adjusted



PRODUCT	CODE	RRP €
AQUAWING BCD XS/XL	IC790000	599,99
BACK WEIGHT BAR 2.5 KG	I2790400	79,99



INTEGRATED CYLINDER REST



AIR-NET MATERIAL



BACK COVER POCKET



BACK WEIGHT POCKETS INCLUDED

EMPEROR



HIGH LIFT CAPACITY | NYLON 420 D HYBRID CELL | FLAT LOCK AID WEIGHT SYSTEM

HIGH VOLUME HYBRID INFLATION B.C.D.

Cressi's Emperor is a jacket with an exclusive design and technical solutions that ensure perfect buoyancy and a snug profile. The shoulder straps are equipped with 50 mm pivoting buckles, offering maximum comfort during movement. The lower strap of the shoulder strap is connected to a ring that allows rotation and thus maximum adaptability. The inside of the jacket is completely made of air-net material, with extra padding to increase comfort and promote water drainage. The two-piece waist band system uses the new patented SPWB (self pivoting waist band)

system. The backrest, which is semi-rigid, soft and padded, allows the G.A.V. to be folded and carried compactly. The integrated Flat Lock Cressi ballast system makes it much easier to remove the weight pockets. There are two pockets on the back to customise weight distribution and always achieve the optimum buoyancy position. In addition, the two integrated supports in the jacket for fixing the tank improve the diver's buoyancy.

TECHNICAL FEATURES

- 50 mm swinging buckles
- Lower shoulder strap connected to a ring for optimal rotation and adjustability.
- Ventral harness with SPWB
- Integrated Flat Lock ballast system
- Customisation of weight distribution



BUOYANCY

SIZE	NEWTON	KG	POUNDS
XS	140	14,2	31
S	160	16,3	35
M	210	21,4	47
L	210	21,4	47

PRODUCT WEIGHT

SIZE	KG	LBS
XS	3,41	7
S	3,43	7
M	3,57	7
L	3,61	8



50mm PIVOTING BUCKLES



FLAT LOCK SYSTEM



PRODUCT	CODE	RRP €
EMPEROR BCD S	IC775002	599.99
EMPEROR BCD M	IC775003	599.99
EMPEROR BCD L	IC775004	599.99
EMPEROR BCD XL	IC775005	599.99

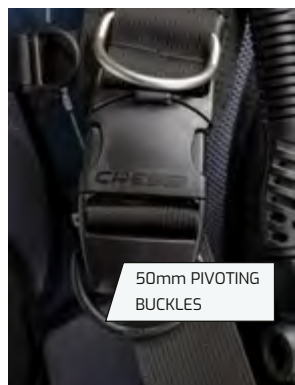

50mm PIVOTING BUCKLES



FULLY ADJUSTABLE WAIST HARNESS



STEEL D-RINGS

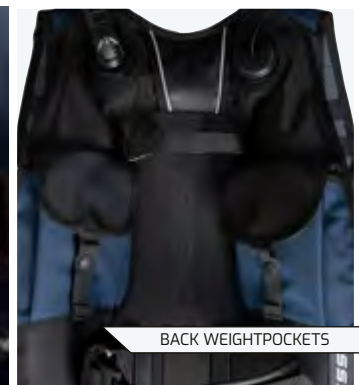

BACK WEIGHTPOCKETS

COMMANDER EVOLUTION

HIGH LIFT CAPACITY | NYLON 420 D BACK CELL | FLAT LOCK AID WEIGHT SYSTEM

HIGH VOLUME BACK INFLATION B.C.D.

The Commander Evolution Jacket is an impressively light high-buoyancy rear-mounted BC, anatomically designed for maximum comfort and wearability. Its main features are its detachable harness and air cell. The rear-mounted air cell interferes neither with the main underwater component nor the adjustment straps, not even when it is inflated to the maximum. This means extra freedom of movement and buoyancy for the diver. The special air cell compression strap guarantees extra quick deflation and volume control. The ultralight rigid back plate with its

integrated carrying handle ensures optimal stability. Its integrated Cressi Flat-Lock Aid weight system makes it extra easy to release the pockets and rear ballast bags (attached to the tank-block band). Accessories include four 50mm shoulder aluminium D-rings and four 25mm aluminium D-rings (of which two on the pockets and two on the lower part of the harness). There are 3 pressure relief valves: one on the upper part of the hose, one reel-operated valve on the right-hand side of the shoulder and a third on the lower right-hand side of the air cell.

TECHNICAL FEATURES

- Development of rear-mounted air cell
- Air cell material: 420 denier nylon
- Integrated Cressi Flat-lock Aid weight System
- 2 rear ballast pouches
- 3 pressure relief valves
- Four 50mm aluminium D-rings on the shoulder straps
- Four 25 mm stainless steel D-rings (2 on the pockets and 2 on the lower part of the harness)
- Ultralight rigid back plate with carrying handle
- Next generation anatomical inflator with hose retainer
- Multipurpose zip pockets
- 50 mm quick-release buckled shoulder straps

BUOYANCY

SIZE	NEWTON	KG	POUNDS
XS	130	13.2	29.2
S	130	13.2	29.2
M	190	19.3	42.7
L	220	22.4	49.4
XL	220	22.4	49.4

PRODUCT WEIGHT

SIZE	KG	LBS
XS	3.1	6.83
S	3.15	6.94
M	3.25	7.16
L	3.4	7.49
XL	3.45	7.6



PRODUCT	CODE	RRP €
COMMANDER EVOLUTION BCD XS	IC771000	649.99
COMMANDER EVOLUTION BCD S	IC771001	649.99
COMMANDER EVOLUTION BCD M	IC771002	649.99
COMMANDER EVOLUTION BCD L	IC771003	649.99
COMMANDER EVOLUTION BCD XL	IC771004	649.99

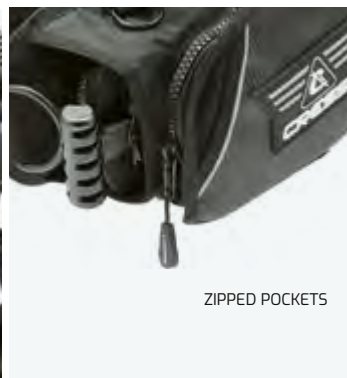

SCORPION SPECIALIZED

Retailer-Product

NYLON 420 D BACK CELL | FLAT LOCK AID WEIGHT SYSTEM

ANATOMICAL BACK INFLATION B.C.D.

The Scorpion Jacket is an impressively light high-buoyancy rear-mounted BC, anatomically designed for maximum comfort and wearability. Its main features are its detachable harness and air cell. The rear-mounted air cell interferes neither with the main underwater component nor with the adjustment straps, not even when it is inflated to the maximum: this means extra freedom of

movement and buoyancy for the diver. The special air cell compression strap guarantees extra quick deflation and volume control. The ultralight semi-rigid harness ensures optimal stability and high comfort with its air-net fabric. Its integrated Cressi Flat-Lock-Aid Weight System makes extra easy to release the pockets.



TECHNICAL FEATURES

- Development of rear-mounted air cell
- Air cell material: 420 denier nylon
- Integrated Cressi Flat-Lock-Aid Weight System on a back vertical position
- 2 pressure relief valves
- Two 50 mm aluminium D-rings on the shoulder straps
- Two 25 mm aluminium D-rings on the pockets
- Ultralight semi-rigid harness
- Next generation anatomical inflator with hose retainer
- Multipurpose zip pockets with weight pockets inside
- 40 mm quick-release buckled shoulder straps
- Side adjustable lumbar flaps

BUOYANCY

SIZE	NEWTON	KG	POUNDS
XS	130	13.2	29.2
S	130	13.2	29.2
M	150	15.2	33.7
L	150	15.2	33.7
XL	150	15.2	33.7

PRODUCT WEIGHT

SIZE	KG	LBS
XS	2.4	5.29
S	2.45	5.4
M	2.5	5.51
L	2.6	5.73
XL	2.65	5.84

PRODUCT	CODE	RRP €
SCORPION BCD XS	IC770000	499.99
SCORPION BCD S	IC770001	499.99
SCORPION BCD M	IC770002	499.99
SCORPION BCD L	IC770003	499.99
SCORPION BCD XL	IC770004	499.99



NYLON 420 D BACK CELL

FLAT LOCK AID WEIGHT SYSTEM

PATROL

ESSENTIAL BACK INFLATION B.C.D.

The Patrol BC is an impressively light weight, rear inflation BC that is anatomically designed for maximum comfort and durability. The special air cell compression strap guarantees extra quick deflation and volume control. The ultralight rigid back plate with its integrated carrying handle ensures optimal stability. The Patrol also features Cressi's Flat-Lock-Aid integrated weight system

that makes it easy to release the pockets. There are 3 pressure relief valves: one on the upper part of the hose, one valve on the right-hand side of the shoulder and a third on the lower right-hand side of the air cell. The Patrol also features plastic d-rings to help reduce weight and the shoulder and waist harness are fully adjustable to one full size up or down from the stated size.

BUOYANCY

SIZE	NEWTON	KG	POUNDS
S	130	13.2	29.2
M	190	19.3	42.7
L	220	22.4	49.4
XL	220	22.4	49.4

PRODUCT WEIGHT

SIZE	KG	LBS
S	2.6	5.73
M	2.75	6.06
L	2.9	6.39
XL	2.9	6.39



PRODUCT	CODE	RRP €
PATROL BCD S	IC741601	419.99
PATROL BCD M	IC741602	419.99
PATROL BCD L	IC741603	419.99
PATROL BCD XL	IC741604	419.99



AQUARIDE

BUOYANCY CONTROL JACKET

Aquaride is a semi-classic structured BC with a special feature: it has adjustable shoulder straps that aren't restricted by the air cell, improving the grip on the tank and improving comfort. Thanks to their anatomical, preformed profile, they are much easier to put on and make resting the tank more comfortable on the shoulders.

The BC features the Flat type Lock Aid System of integrated weight. It is very effective and comfortable thanks to its extremely flat profile and the easy and intuitive arrangement of the pockets. Finally, the anatomical control has a hose retainer, making all inflation and deflation operations very easy and intuitive.

NYLON 420 D STANDARD CELL | FLAT LOCK AID WEIGHT SYSTEM

TECHNICAL FEATURES

- 420 Denier Nylon bag.
- Flat system Lock Aid System integrated weight.
- Superlight rigid backpack with handle.
- Next generation anatomical inflator with hose retainer.
- Expandable sundries pocket with zip closure.
- Quick-attach rear weight pockets (capacity 2 kg).
- 2 overpressure valves.

BUOYANCY

SIZE	NEWTON	KG	POUNDS
XS	80	8,1	17,9
S	90	9,1	20,2
M	130	13,2	29,2
L	160	16,3	35,9
XL	190	19,3	42,7

PRODUCT WEIGHT

SIZE	KG	LBS
XS	3,0	6,61
S	3,1	6,83
M	3,2	7,05
L	3,3	7,27
XL	3,4	7,49



PRODUCT	CODE	RRP €
AQUARIDE BCD BLUE XS	IC740800	469,99
AQUARIDE BCD BLUE S	IC740801	469,99
AQUARIDE BCD BLUE M	IC740802	469,99
AQUARIDE BCD BLUE L	IC740803	469,99
AQUARIDE BCD BLUE XL	IC740804	469,99



ELETTRA SPECIALIZED

Retailer-Product

DESIGNED FOR FEMALE ANATOMY | FLAT LOCK AID WEIGHT SYSTEM

SPECIFICALLY DESIGNED FOR WOMEN

The Elettra jacket has been conceived to adapt to the female anatomy. The exclusive design and technical features provide perfect buoyancy with a close-fitting profile. The 40 mm buckles (shoulder-waist) adapt perfectly to the female anatomy. The lower band of the shoulder strap is anchored to a ring to ensure rotation and therefore maximum adaptability to the female anatomy. The internal part is fully lined with air-net material, with thicker padding to increase comfort and improve water

drainage. The two-piece waist band uses the new patented SPWB (Self Pivoting Waist Band) system. The soft and padded semi-rigid back plate permits the BCD to be folded and transported with the minimum possible volume. The Cressi Flat Lock integrated ballast system makes the extraction of the weight bags particularly easy. The jacket's two integrated cylinder supports improve the diver's trim.

TECHNICAL FEATURES

- Female anatomy (SIZES: XS-S-M-L)
- Air bladder: nylon 420 D
- Pockets and shoulder straps: cordura 1500 D
- Self Pivoting Waist Band
- Integrated Cressi Flat-Lock Aid weight System
- 2 zip up pockets for accessories
- Semi-rigid harness
- 6 D-rings in stainless steel
- 2 overpressure valves



BUOYANCY

SIZE	NEWTON	KG	POUNDS
XS	100	10,1	22,4
S	100	10,1	22,4
M	140	14,2	31,4
L	160	16,3	35,9

PRODUCT WEIGHT

SIZE	KG	LBS
XS	2,95	6,5
S	3	6,61
M	3,1	6,83
L	3,15	6,94



PRODUCT	CODE	RRP €
ELETTRA BCD XS	IC774001	569,99
ELETTRA BCD S	IC774002	569,99
ELETTRA BCD M	IC774003	569,99
ELETTRA BCD L	IC774004	569,99





Photo by: Wojciech Dopierala



Photo by: Voyages of Agape



Photo by: Jason Washington

TRAVELIGHT

TRAVEL B.C.D.

This combination of lightness, flexibility and equipment make this model a perfect option not only for diving travels but also for divers who value

comfort, hydrodynamics and freedom sensation of light and simple jackets.

NYLON 210 D STANDARD CELL | FLAT LOCK AID WEIGHT SYSTEM

TECHNICAL FEATURES

- 210 denier nylon material, rubbery material (rear)
- 2 zip up pockets for accessories
- 2 rear weight carrying pockets
- Soft, padded back, with double strap for fixing the tank
- D-rings and rings in light alloy.
- 2 overpressure valves
- Rear release valve with control brought to the front
- FAST system for folding and compacting the BC
- Velcro strap, closed in a lower zip up pocket for packing the BC.

BUOYANCY

SIZE	NEWTON	KG	POUNDS
XS	60	6.1	13.4
S	80	8.1	17.9
M	90	9.1	20.2
L	130	13.2	29.2
XL	160	16.3	35.9

PRODUCT WEIGHT

SIZE	KG	LBS
XS	2.4	5.29
S	2.4	5.29
M	2.5	5.51
L	2.5	5.51
XL	2.6	5.73



BLUE

PINK

PRODUCT	CODE	RRP €
TRAVELIGHT BCD BLUE XS	IC740600	479.99
TRAVELIGHT BCD BLUE S	IC740601	479.99
TRAVELIGHT BCD BLUE M	IC740602	479.99
TRAVELIGHT BCD BLUE L	IC740603	479.99
TRAVELIGHT BCD BLUE XL	IC740604	479.99
TRAVELIGHT LADY BCD PINK XS	IC740620	479.99
TRAVELIGHT LADY BCD PINK S	IC740621	479.99
TRAVELIGHT LADY BCD PINK M	IC740622	479.99



FLAT LOCK SYSTEM



FAST FOLDING SYSTEM



LIGHT ALLOY D-RINGS

40mm BUCKLES

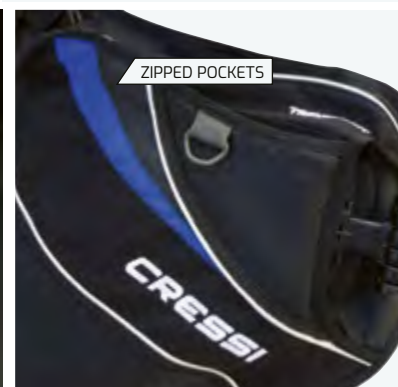

ZIPPED POCKETS

START PRO

ROBUST WEIGHT POCKET INTEGRATED B.C.D.

Its high level of buoyancy (notably in the smaller models) makes this jacket ideal for beginners, diving schools or renting.



HIGH LIFT CAPACITY | CORDURA 500 D STANDARD CELL | FIXED GRAVITY POCKETS

TECHNICAL FEATURES

- 500 denier cordura (exterior) and 420 denier nylon (interior)
- External ballast-carrying pockets with quick-release safety buckle
- 2 very big multipurpose zip pockets
- ultralight rigid backplate with carrying handle.
- 2 pressure relief valves.
- Four 40 mm engineering plastic D-rings (2 on the shoulder straps and 2 on the lower part of the air cell).
- Two 25mm engineering plastic D-rings on the pockets.
- Size indicated clearly on the shoulder strap.
- Shoulder straps with 50mm buckles.

BUOYANCY

SIZE	NEWTON	KG	POUNDS
XXS	70	7.1	15.7
Xs	130	13.2	29.2
S	140	14.2	31.4
M	150	15.2	33.7
L	170	17.3	38.2
XL	200	20.3	44.9
XXL	200	20.3	44.9

PRODUCT WEIGHT

SIZE	KG	LBS
XXS	2.4	5.29
Xs	2.5	5.51
S	2.5	5.51
M	2.75	6.06
L	2.8	6.17
XL	2.9	6.39
XXL	2.9	6.39

PRODUCT	CODE	RRP €
START PRO BCD 2XS	IC721905	379.99
START PRO BCD XS	IC721900	379.99
START PRO BCD S	IC721901	379.99
START PRO BCD M	IC721902	379.99
START PRO BCD L	IC721903	379.99
START PRO BCD XL	IC721904	379.99
START PRO BCD 2XL	IC721906	379.99



FIXED GRAVITY POCKET SYSTEM

GAUGE AND OCTOPUS HOLDER

ENGINEERED PLASTIC D-RINGS

50 mm BUCKLES

START

ROBUST B.C.D.

Simple, robust and efficient jacket designed for diving centers' needs and for professional work

companies that want a reliable product, of great resistance and with affordable price.



TECHNICAL FEATURES

- It has a sack that combines Cordura® 1000 Deniers on the outside, pockets and shoulder pads, and 500 Deniers on the inside part.
- Manometer and octopus fixation integrated system, really useful especially for diving centers.
- High-capacity pockets with closing by Velcro and a wide lapel.
- Abdominal strap separated from the sack to eliminate the oppression during the inflation.
- Chest strap.
- Very light and resistant semi rigid back pack.
- Size visible on the right shoulder pad.
- Small pocket over the shoulder pad that allows introducing in the octopus' hose folded.
- Direct System with double air filtering system easily removable in case of emergency cleaning.
- Extraordinary relationship size / ascensional capacity thanks to its new pattern and to the spacers installed inside the sack: T/XS 13.3 kg; T/S 14,3 kg; T/M 15.3 kg; T/L 17.3 kg; T/XL 20.4 kg.

BUOYANCY

SIZE	NEWTON	KG	POUNDS
XS	130	13,2	29,2
S	140	14,2	31,4
M	150	15,2	33,7
L	170	17,3	38,2
XL	200	20,3	44,9

PRODUCT WEIGHT

SIZE	KG	LBS
XS	2,4	5,29
S	2,5	5,51
M	2,6	5,73
L	2,7	5,95
XL	2,8	6,17

PRODUCT	CODE	RRP €
START BCD XS	IC721700	349,99
START BCD S	IC721701	349,99
START BCD M	IC721702	349,99
START BCD L	IC721703	349,99
START BCD XL	IC721704	349,99



GAUGE AND OCTOPUS HOLDER

SIZE ON SHOULDER PAD

COMPACT TANK BACKPACK

SOLID PLUS

WEIGHT INTEGRATED B.C.D. FOR DIVE CENTERS

The Solid Plus is the evolution of the Solid model to offer greater safety and convenience for dive centres and divers. Equipped with the new Quick Lock System weight release system, it allows quick and safe one-handed release of ballasts. Made of 500 denier Cordura on the outside and 420 denier nylon on the inside, it offers strength and durability. The back features a coloured band to increase visibility in the water and protect the jacket from abrasion. Equipped with a super-light

rigid back with carrying handle, a whistle integrated in the sternal buckle, three relief valves and practical technopolymer D-rings. The adjustable shoulder straps with 50 mm buckles guarantee an optimal fit and clearly indicate the size of the jacket, offering great practicality in rental activities. Solid Plus is the Cressi proposal for the best dive centres looking for a superior jacket for rental and school activities.

TECHNICAL FEATURES

- Quick Lock System
- Increased Visibility
- Integrated Whistle
- Optimal Fit and Size Indication
- Made of 500 denier Cordura and 420 denier nylon for strength and durability.

BUOYANCY

SIZE	NEWTON	KG	POUNDS
XXS	80	8,1	17 ⁷ / ₈
XS	120	12,2	26 ⁷ / ₈
S	140	14,2	31 ¹ / ₄
M	160	16,3	35 ⁷ / ₈
L	190	19,3	42 ¹ / ₂
XL	220	22,4	49 ³ / ₈
XXL	220	22,4	49 ³ / ₈

PRODUCT WEIGHT

SIZE	KG	LBS
XXS	2,6	5 ³ / ₄
XS	2,85	6 ¹ / ₄
S	2,9	6 ³ / ₈
M	2,95	6 ¹ / ₂
L	3	6 ⁵ / ₈
XL	3,1	6 ⁷ / ₈
XXL	3,11	6 ⁷ / ₈



PRODUCT	CODE	RRP €
SOLID PLUS BCD 2XS	JIC741600	399,99
SOLID PLUS BCD XS	JIC741601	399,99
SOLID PLUS BCD S	JIC741602	399,99
SOLID PLUS BCD M	JIC741603	399,99
SOLID PLUS BCD L	JIC741604	399,99
SOLID PLUS BCD XL	JIC741605	399,99
SOLID PLUS BCD 2XL	JIC741606	399,99



GAUGE AND OCTOPUS HOLDER



HIGH VISIBILITY BACK PAD



50mm BUCKLES



QUICK LOCK WEIGHT



ULTRA RESISTANT MATERIALS

SOLID

DESIGNED FOR DIVE CENTERS

Jacket Solid: Good buoyancy, ideal for scuba diving schools and equipment rental centres. It features a coloured reinforcement band in the upper part of the back, at neck level, to enhance visibility in

the water and protect the jacket from the abrasive action of the first stage. The sternal attachment is closed by a buckle which also serves as a safety whistle.



TECHNICAL FEATURES

- 500D Cordura (exterior part) and 420D Nylon (interior)
- 2 large accessory holder zip-up pockets
- Light-weight, rigid backplate with carry handle.
- 2 overpressure dump valves
- 2 25 mm technopolymer D-rings on the pockets
- Size shown on shoulder straps
- 50 mm shoulder straps with buckles.

BUOYANCY

SIZE	NEWTON	KG	POUNDS
XXS	80	8.1	17.9
XS	120	12.2	26.9
S	140	14.2	31.4
M	160	16.3	35.9
L	190	19.3	42.7
XL	220	22.4	49.4
XXL	n/a	n/a	n/a

PRODUCT WEIGHT

SIZE	KG	LBS
XXS	2.1	4.63
XS	2.2	4.85
S	2.25	4.96
M	2.3	5.07
L	2.35	5.18
XL	2.4	5.29
XXL	n/a	n/a



PRODUCT	CODE	RRP €
SOLID BCD DIVE CENTER EDITION 2XS	JIC741705	329.99
SOLID BCD DIVE CENTER EDITION XS	JIC741700	329.99
SOLID BCD DIVE CENTER EDITION S	JIC741701	329.99
SOLID BCD DIVE CENTER EDITION M	JIC741702	329.99
SOLID BCD DIVE CENTER EDITION L	JIC741703	329.99
SOLID BCD DIVE CENTER EDITION XL	JIC741704	329.99
SOLID BCD DIVE CENTER EDITION 2XL	JIC741706	329.99



AQUAWING PLUS SCUBA SET

HIGH PERFORMANCE SET - ONE SIZE FITS ALL

A COMPLETE SCUBA SET INCLUDING:
 B.C.D. Aquawing Plus black
 1st stage MC9 SC
 2nd stage compact pro
 Octopus compact pro
 Digi2 console



PRODUCT UPDATE

TECHNICAL FEATURES 1ST STAGE

- Balanced diaphragm (seal chamber for MC9SC)
- 2 outlets HP 7/16 UNF
- 4 outlets MP 3/8 UNF
- Service pressure: 300 bar (4350 psi) DIN version, 232 bar (3365 psi) Yoke version
- Calibration pressure: 10 Bar
- Brass body Electroless Nickel plated
- High capacity conical filter electroless nickel plated
- Aisi 316 removable nozzle
- Hyper-balancing
- Anti-pressure drop pneumatic spring
- Setting spring: stainless steel with micropeening treatment
- Replaceable cylinder with anti-friction and anti-corrosion properties
- Elastomer protector
- Flow rate: 4500 l/min
- Yoke version weight: 590 gr
- Din version weight: 450 gr

TECHNICAL FEATURES 2ND STAGE

- Improved reliability front cover (more impact resistant)
- Downstream system
- Adjustable Venturi effect
- Patented antifriction lever
- Thermoconductive technopolymer body
- Big purge button
- Anti-scratch surface
- Bayonet-type cap holder with security lock
- Removable exhaust tee
- Weight without hose: 140 gr

COMBINATION PERFORMANCE

- Average Cracking effort 7.5 mbar
- Average breathing effort 1 J/l

Jacketed hose extremely light and flexible weight: 153 gr

Certification EN250/2014 for cold waters

TECHNICAL FEATURES B.C.D.

- One-size-fits-all (XS / XL)
- Air bladder: 210 D nylon
- Air bladder cover: 1500 D cordura
- MAS (Modular Adjustment System)
- 4 Stainless steel D-ring

BUOYANCY

SIZE	NEWTON	KG	POUNDS
XS-XL	120	12.2	26.9

PRODUCT WEIGHT

SIZE	KG	LBS
XS-XL	3,75	8,26

PRODUCT	CODE	RRP €
SET SCUBA AQUAWING PLUS DIGIPACK INT	IY790220	1149,99
SET SCUBA AQUAWING PLUS DIGIPACK DIN	IY790221	1149,99

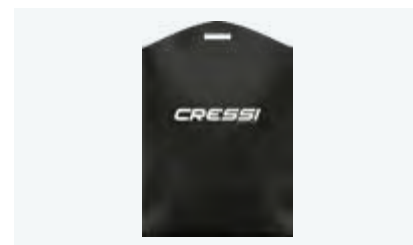

NEW 2025

SOLID PLUS SCUBA SET

ROBUST DIVE CENTER SET

A COMPLETE SCUBA SET INCLUDING:
 B.C.D. Solid Plus
 1st stage AC5
 2nd stage Zen
 Octopus Zen
 Mini SPG



TECHNICAL FEATURES 1ST STAGE

- New piston 1st stage with INT or DIN 300bar connection.
- 4 L.P. ports, 1 HP port for optimal hose orientation.
- Direct external IP calibration system for precise pressure adjustment.
- IP calibration value: 9.5-10bar for consistent performance.
- New optimized 1st stage design for maximum flow.
- Conical filter for improved filtration in both versions.
- Single maintenance kit for both INT and DIN versions.
- Increased water passage slots for better pressure balance.
- Enlarged tool housing holes for easier servicing.
- CE EN250 certification pending for warm water use.
- Glossy finish with "Gun Metal" DIN wheel.
- Interchangeable parts with AC25 and AC2 models.
- Weight, INT version: 670g
- Weight, DIN version: 495g

TECHNICAL FEATURES 2ND STAGE

- Downstream system
- Adjustable Venturi effect
- Patented antifriction lever
- Big purge button
- Double injection purge button
- Radial pressure transmission openings
- Anti-scratch surface
- Bayonet-type cap holder with security lock
- Removable exhaust tee without tools
- Weight without hose: 149 gr

TECHNICAL FEATURES B.C.D.

- Quick Lock System
- Increased Visibility
- Integrated Whistle
- Optimal Fit and Size Indication
- Made of 500 denier Cordura and 420 denier nylon for strength and durability.

BUOYANCY

SIZE	NEWTON	KG	POUNDS
XXS	80	8.1	17 ^{7/8}
X5	120	12.2	26 ^{7/8}
S	140	14.2	31 ^{1/4}
M	160	16.3	35 ^{7/8}
L	190	19.3	42 ^{1/2}
XL	220	22.4	49 ^{3/8}
XXL	220	22.4	49 ^{3/8}

PRODUCT WEIGHT

SIZE	KG	LBS
XXS	2.6	5 ^{3/4}
X5	2.85	6 ^{1/4}
S	2.9	6 ^{3/8}
M	2.95	6 ^{1/2}
L	3	6 ^{5/8}
XL	3.1	6 ^{7/8}
XXL	3.11	6 ^{7/8}

PRODUCT	INT	DIN	RRP €
SOLID PLUS SCUBA SET 2XS	IY731100	IY731200	749.99
SOLID PLUS SCUBA SET X5	IY731101	IY731201	749.99
SOLID PLUS SCUBA SET S	IY731102	IY731202	749.99
SOLID PLUS SCUBA SET M	IY731103	IY731203	749.99
SOLID PLUS SCUBA SET L	IY731104	IY731204	749.99
SOLID PLUS SCUBA SET XL	IY731105	IY731205	749.99
SOLID PLUS SCUBA SET 2XL	IY731106	IY731206	749.99

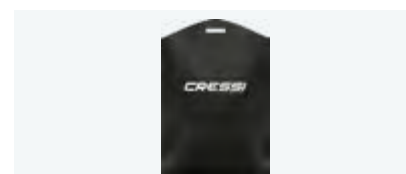

START PRO SCUBA SET

SCUBA SET

A COMPLETE SCUBA SET INCLUDING:
B.C.D. Start Pro
1st Stage MC9
2nd Stage Compact
Octopus Compact
Console 2



A READY TO USE SET
TO START SCUBA DIVING

CONVENIENT AND
QUALITY EQUIPMENT

TECHNICAL FEATURES 1ST STAGE

- Balanced diaphragm (seal chamber for MC95C)
- 2 outlets HP 7/16 UNF
- 4 outlets MP 3/8 UNF
- Service pressure: 300 bar (4350 psi) DIN version, 232 bar (3365 psi) Yoke version
- Calibration pressure: 10 Bar
- Brass body Electroless Nickel plated
- High capacity conical filter electroless nickel plated
- Aisi 316 removable nozzle
- Hyper-balancing
- Anti-pressure drop pneumatic spring
- Setting spring: stainless steel with micropeening treatment
- Replaceable cylinder with anti-friction and anti-corrosion properties
- Elastomer protector
- Flow rate: 4500 l/min
- Yoke version weight: 590 gr
- Din version weight: 450 gr

TECHNICAL FEATURES 2ND STAGE

- Downstream system
- Adjustable Venturi effect
- Patented antifricion lever
- Big purge button
- Anti-scratch surface
- Bayonet-type cap holder with security lock
- Removable exhaust tee without tools
- Weight without hose: 135 gr

Jacketed hose extremely light and flexible
weight: 153 gr

Certification EN250/2014 A>10° C

TECHNICAL FEATURES

- 500 denier cordura (exterior) and 420 denier nylon (interior)
- External ballast-carrying pockets with quick-release safety buckle
- 2 very big multipurpose zip pockets
- ultralight rigid backplate with carrying handle.
- 2 pressure relief valves.
- Four 40 mm engineering plastic D-rings (2 on the shoulder straps and 2 on the lower part of the air cell).
- Two 25mm engineering plastic D-rings on the pockets.
- Size indicated clearly on the shoulder strap.
- Shoulder straps with 50mm buckles.

BUOYANCY

SIZE	NEWTON	KG	POUNDS
XXS	70	7.1	15.7
XS	130	13.2	29.2
S	140	14.2	31.4
M	150	15.2	33.7
L	170	17.3	38.2
XL	200	20.3	44.9
XXL	200	20.3	44.9

PRODUCT	CODE	RRP €
START PRO SCUBA SET/INT XS	IY721800	849,99
START PRO SCUBA SET/INT S	IY721801	849,99
START PRO SCUBA SET/INT M	IY721802	849,99
START PRO SCUBA SET/INT L	IY721803	849,99
START PRO SCUBA SET/INT XL	IY721804	849,99
START PRO SCUBA SET/DIN XS	IY721810	849,99
START PRO SCUBA SET/DIN S	IY721811	849,99
START PRO SCUBA SET/DIN M	IY721812	849,99
START PRO SCUBA SET/DIN L	IY721813	849,99
START PRO SCUBA SET/DIN XL	IY721814	849,99

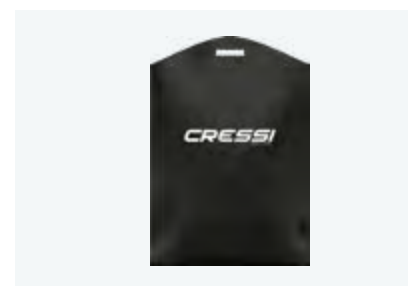

START SCUBA SET

SCUBA SET

A COMPLETE SCUBA SET INCLUDING:
 B.C.D. Start
 1st stage AC2
 2nd stage compact
 Octopus compact
 Pressure Gauge



TECHNICAL FEATURES 1ST STAGE

- Unbalanced piston
- 1 outlets HP 7/16 UNF
- 4 outlets MP 3/8 UNF
- Service pressure: 300 bar (4350 psi) DIN version, 232 bar (3365 psi) Yoke version
- Calibration pressure: 9,5-10 Bar
- Brass body Electroless Nickel plated
- High capacity conical filter electroless nickel plated
- Aisi 316 long lasting piston
- Easy external direct IP adjustment system
- Stainless steel spring
- Flow rate: 2100 l/min
- Yoke version weight: 635 gr
- Din version weight: 495 gr

TECHNICAL FEATURES 2ND STAGE

- Downstream system
- Adjustable Venturi effect
- Patented antifriction lever
- Big purge button
- Anti-scratch surface
- Bayonet-type cap holder with security lock
- Removable exhaust tee without tools
- Weight without hose: 135 gr

Jacketed hose extremely light and flexible weight: 153 gr

Certification EN250/2014 A>10° C

TECHNICAL FEATURES B.C.D.

- It has a sack that combines Cordura® 1000 Deniers on the outside, pockets and shoulder pads, and 500 Deniers on the inside part.
- Manometer and octopus fixation integrated system, really useful especially for diving centers.
- High-capacity pockets with closing by Velcro and a wide lapel.
- Abdominal strap separated from the sack to eliminate the oppression during the inflation.
- Chest strap.
- Very light and resistant semi rigid back pack.
- Size visible on the right shoulder pad.
- Small pocket over the shoulder pad that allows introducing in the octopus' hose folded.
- Direct System with double air filtering system easily removable in case of emergency cleaning.
- Extraordinary relationship size / ascensional capacity thanks to its new pattern and to the spacers installed inside the sack: T/XS 13.3 kg; T/S 14.3 kg; T/M 15.3 kg; T/L 17.3 kg; T/XL 20.4 kg.

BUOYANCY

SIZE	NEWTON	KG	POUNDS
XS	130	13.2	29.2
S	140	14.2	31.4
M	150	15.2	33.7
L	170	17.3	38.2
XL	200	20.3	44.9

PRODUCT	CODE	RRP €
START SCUBA SET/INT XS	IY721700	699,99
START SCUBA SET/INT S	IY721701	699,99
START SCUBA SET/INT M	IY721702	699,99
START SCUBA SET/INT L	IY721703	699,99
START SCUBA SET/INT XL	IY721704	699,99
START SCUBA SET/DIN XS	IY721710	699,99
START SCUBA SET/DIN S	IY721711	699,99
START SCUBA SET/DIN M	IY721712	699,99
START SCUBA SET/DIN L	IY721713	699,99
START SCUBA SET/DIN XL	IY721714	699,99

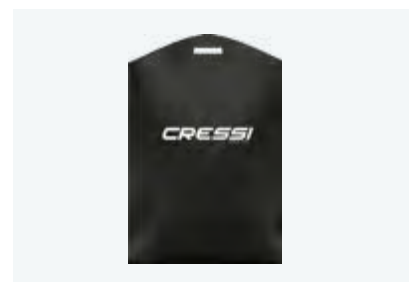

SOLID SCUBA SET

SPECIFIC FOR DIVE CENTERS

A COMPLETE SCUBA SET INCLUDING:

- B.C.D. Solid
- 1st stage AC2
- 2nd stage compact
- Octopus compact
- Pressure Gauge



A READY TO USE SET
TO START SCUBA DIVING

CONVENIENT AND
QUALITY EQUIPMENT

TECHNICAL FEATURES 1ST STAGE

- Unbalanced piston
- 1 outlets HP 7/16 UNF
- 4 outlets MP 3/8 UNF
- Service pressure: 300 bar (4350 psi) DIN version, 232 bar (3365 psi) Yoke version
- Calibration pressure: 9.5-10 Bar
- Brass body Electroless Nickel plated
- High capacity conical filter electroless nickel plated
- Aisi 316 long lasting piston
- Easy external direct IP adjustment system
- Stainless steel spring
- Flow rate: 2100 l/min
- Yoke version weight: 635 gr
- Din version weight: 495 gr

TECHNICAL FEATURES 2ND STAGE

- Downstream system
- Adjustable Venturi effect
- Patented antifriction lever
- Big purge button
- Anti-scratch surface
- Bayonet-type cap holder with security lock
- Removable exhaust tee without tools
- Weight without hose: 135 gr

Jacketed hose extremely light and flexible weight: 153 gr

Certification EN250/2014 A-10° C

TECHNICAL FEATURES B.C.D.

- 500D Cordura (exterior part) and 420D Nylon (interior)
- 2 large accessory holder zip-up pockets
- Light-weight, rigid backplate with carry handle.
- 2 overpressure dump valves
- 2 25 mm technopolymer D-rings on the pockets
- Size shown on shoulder straps
- 50 mm shoulder straps with buckles.

BUOYANCY

SIZE	NEWTON	KG	POUNDS
XXS	80	8,1	17,9
Xs	120	12,2	26,9
S	140	14,2	31,4
M	160	16,3	35,9
L	190	19,3	42,7
XL	220	22,4	49,4
XXL	n/a	n/a	n/a

PRODUCT	CODE	RRP €
SOLID SCUBA SET INT 2XS	IY730100	649,99
SOLID SCUBA SET INT XS	IY730101	649,99
SOLID SCUBA SET INT S	IY730102	649,99
SOLID SCUBA SET INT M	IY730103	649,99
SOLID SCUBA SET INT L	IY730104	649,99
SOLID SCUBA SET INT XL	IY730105	649,99
SOLID SCUBA SET INT 2XL	IY730106	649,99
SOLID SCUBA SET DIN 2XS	IY730200	649,99
SOLID SCUBA SET DIN XS	IY730201	649,99
SOLID SCUBA SET DIN S	IY730202	649,99
SOLID SCUBA SET DIN M	IY730203	649,99
SOLID SCUBA SET DIN L	IY730204	649,99
SOLID SCUBA SET DIN XL	IY730205	649,99
SOLID SCUBA SET DIN 2XL	IY730206	649,99

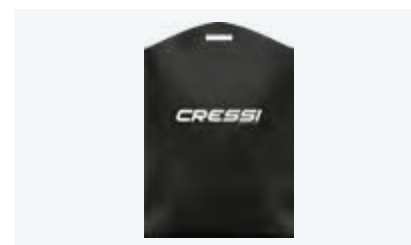

AQUAWING MODULAR SYSTEM KIT



CODE		RRP €
IZ790200		99.99

AQUAWING BACK PLATE 2.5 KG BAR

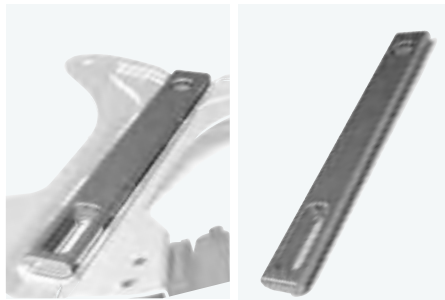

CODE		RRP €
IZ790400		79.99

SPIRAL LANYARD WITH CLIP SNAP



CODE		RRP €
JA800100		29.99

SPIRAL LANYARD WITH RING



CODE		RRP €
JA800000		25.99

HOSE HOLDER CLIP 3 BLACK



CODE		RRP €
HZ734250		5.99

WRITING SLATE 150 X 127 MM



CODE		RRP €
JA700012		9.99

MAGNETIC SHAKER



CODE		RRP €
JA702000		44.99

MINI AUTO-RECOIL LANYARD



CODE		RRP €
TA700200		24.99

/ B.C.D.'S ACCESSORIES

/ B.C.D.'S SPARE PARTS

EMPEROR CUMMERBAND

NEW 2025

DESCRIPTION	CODE		RRP €
CUMMERBAND S	I2750152		49,99
CUMMERBAND M	I2750153		49,99
CUMMERBAND L	I2750154		49,99
CUMMERBAND XL	I2750155		49,99

ELETTRA WAIST BAND

DESCRIPTION	CODE		RRP €
ELETTRA WAIST BAND XS	I2790100		49,99
ELETTRA WAIST BAND S	I2790101		49,99
ELETTRA WAIST BAND M	I2790102		49,99
ELETTRA WAIST BAND L	I2790103		49,99

B.C.D.'S INFLATION HOSE

PRODUCT	CODE		RRP €
STANDARD INFLATION HOSE B.C.D.'S (CM.69)	I2750040		39,99

AQUAWING WEIGHT POCKET



CODE		RRP €
I2790300		19,99

DESCRIPTION:
Internal weight pocket spare parts
SUITABLE FOR:
Aquawing BCDs

BY-PASS INFLATOR



CODE		RRP €
I2750244		55,99

DESCRIPTION:
By-Pass inflator two-piece for jacket
SUITABLE FOR:
All Cressi B.C.D.'S

COMPLETE INFLATOR

NEW 2025



PRODUCT	CODE		RRP €
BCD'S	I2750243		109,99
AQUAWING	I2750242		109,99

DESCRIPTION:
Complete inflator for jacket, By-Pass included
SUITABLE FOR:
All Cressi B.C.D.'S
Aquawing series

BACK WEIGHT POCKET

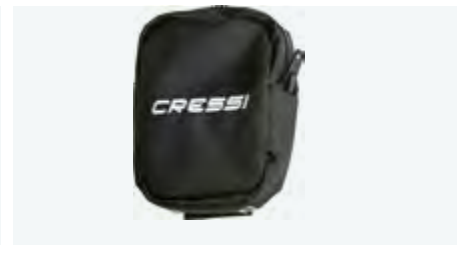

CODE		RRP €
IC760099		32,99

DESCRIPTION:
Cam Band Trim / Tank Strap Back Weight Pocket
SUITABLE FOR:
COMMANDER EVOLUTION - PATROL



WEIGHT POCKET - 2 KG

NEW 2025



CODE		RRP €
IZ750520		37,99

DESCRIPTION:
Flat Lock weight pocket for Solid Plus
SUITABLE FOR:
Solid Plus for XXS only

WEIGHT POCKET - 4,5 KG

NEW 2025



CODE		RRP €
IZ750541		37,99

DESCRIPTION:
Flat Lock weight pocket for Solid Plus
SUITABLE FOR:
Solid Plus from XS to XXL

FLAT LOCK A.S. POCKET



CODE		RRP €
IZ750094		37,99

DESCRIPTION:
Flat Lock Aid System weight pocket for Cressi Jacket
SUITABLE FOR:
Check compatibility at B.C.D.'s comparison table

O-RING KIT

NEW 2025



CODE		RRP €
IZ750080		-
IZ750087		

DESCRIPTION:
O-ring kit for inflator
SUITABLE FOR:
All BCD's - IZ750080
Aquawing series - IZ750087

INFLATION MECHANISM



CODE		RRP €
IZ750032		-

DESCRIPTION:
Inflation mechanism

VALVE MECHANISM



CODE		RRP €
IZ750248		-

DESCRIPTION:
Complete valve mechanism

SEALING GASKET



CODE		RRP €
IZ750074		-

DESCRIPTION:
Sealing gasket for B.C.D.'s exhaust valve

COMPLETE EMPTY CORRUGATED HOSE

NEW 2025



CODE		RRP €
IZ750272		-
IZ750282		-

DESCRIPTION:
Cressi Complete Empty Corrugated Hose for BCD Inflator
SUITABLE FOR:
All BCD's - IZ750272
Aquawing series - IZ750282



Photo by: Lorenzo Mittiga

/ B.C.D. 'S COMPARISON TABLE



	AQUAWING MAX	AQUAWING PLUS	AQUAWING	EMPEROR	COMMANDER EVO	SCORPION	PATROL
TYPE OF AIR CELL MATERIAL	Back Cell Nylon 210 D Cordura 1500 D	Back Cell Nylon 210 D Cordura 1500 D	Back Cell Nylon 210 D Cordura 1500 D	Standard Nylon 420 D	Back Cell Nylon 420 D	Back cell Nylon 420 D	Back cell Nylon 420 D
BUOYANCY IN NEWTON							
XXS				-	-	-	-
XS				-	130	130	130
S	ONE-SIZE X5-XL	ONE-SIZE X5-XL	ONE-SIZE X5-XL	140	130	130	130
M				160	190	150	190
L	170	120	120	210	220	150	220
XL				210	220	150	220
XXL				-	-	-	-
TYPE OF BACKPLATE / CYLINDER FIXING	Rigid / Double strap	Rigid / Double strap	Rigid / Double strap	Soft / Double strap	Rigid / Single strap	Soft / Double strap	Rigid / Single strap
COMPATIBLE CYLINDERS LITRES - DIAMETER MM	MONO 10/12/15/18 - 171/203/216	MONO 10/12/15/18 - 171/203/216	MONO 10/12/15/18 - 171/203/216	MONO 10/12/15/18 - 171/203/216	MONO 10/12/15/18 - 171/203/216	MONO 10/12/15/18 - 171/203/216	MONO 10/12/15/18 - 171/203/216
INTEGRATED WEIGHT POCKETS - MAX KG FOR POCKET	Fixed gravity pocket - 3+3	Fixed gravity pocket - 3+3	NO	Flat lock aid - 4,5+4,5	Flat lock aid - 4,5+4,5	Flat lock aid - 4,5+4,5	Flat lock aid - 4,5+4,5
ABDOMINAL ADJUSTMENT	Buckle	Buckle	Buckle	Buckle + SPWB (self pivoting waistband) "B"	Buckle	Buckle	Buckle + LAS (length adj. system)
STERNAL ADJUSTMENT	No	No	No	Movable	Fixed	Movable	Fixed
SHOULDER STRAP ADJUSTMENT	MAS (Modular Adjustment System)	MAS (Modular Adjustment System)	MAS (Modular Adjustment System)	Standard + Pivoting Buckle	Standard	Standard	Standard + LAS (length adj. system)
QUICK DUMP AND OVER-PRESSURE VALVES							
N°	1	1	1	2	2	2	2
DISCHARGE KNOB POSITION	At the back, lower left area	At the back, lower left area	At the back, lower left area	At the back, lower right area At the front, upper right Area	At the back, lower right area At the front, upper right Area	At the back, lower right area At the front, upper right Area	At the back, lower right area At the front, upper right Area
TOTAL DUMP VALVES	3	3	3	4	4	4	4
N° CHARGE VALVES	2	2	2	2	2	2	2
TYPE OF CONTROL UNIT	FLAT	FLAT	FLAT	FLAT	FLAT	FLAT	FLAT
N° OF POCKETS	No	No	No	2	2	2	1
N° OF BACK POCKETS	2	2	2	-	2	-	-
N° OF "D" RINGS	4	4	2	6	10	4	6
B.C.D. WEIGHT & TOTAL BALLAST THAT CAN BE USED (KG)							
XXS				-	-	-	-
XS				-	3,1 - 14	2,4 - 11	2,6 - 9
S	ONE-SIZE X5-XL	ONE-SIZE X5-XL	ONE-SIZE X5-XL	n/a - 14	3,15 - 14	2,45 - 11	2,6 - 9
M				3,8 - 14	3,25 - 14	2,5 - 13	2,75 - 9
L	3,9 - 11	3,75 - 11	2,9 - 5	n/a - 14	3,4 - 14	2,6 - 13	2,9 - 9
XL				n/a - 14	3,45 - 14	2,65 - 13	2,9 - 9
XXL				-	-	-	-
WEARABILITY: CHEST (CM) - WAIST (CM) - WEIGHT (KG)							
XXS				-	-	-	-
XS				-	80/90 75/90 55/65	80/90 75/90 55/65	80/90 75/90 55/65
S	ONE-SIZE X5-XL	ONE-SIZE X5-XL	ONE-SIZE X5-XL	90/100 85/95 63/78	90/100 85/95 63/78	90/100 85/95 63/78	90/100 85/95 63/78
M	80-130 75-130 55-125	80-130 75-130 55-125	80-130 75-130 55-125	100/110 95/105 75/85	100/110 95/105 75/85	100/110 95/105 75/85	100/110 95/105 75/85
L				105/115 100/110 80/100	105/115 100/110 80/100	105/115 100/110 80/100	105/115 100/110 80/100
XL				115/125 110/120 110/120	115/125 110/120 110/120	115/125 110/120 110/120	115/125 110/120 110/120
XXL				-	-	-	-



	AQUARIDE	ELETTRA	TRAVELIGHT	START PRO	START	SOLID PLUS	SOLID
TYPE OF AIR CELL MATERIAL	Standard Nylon 420 D	Standard Nylon 420 D	Standard Nylon 210 D	Standard Cordura 500 D	Standard Cordura 500 D	Standard Cordura 500 D	Standard Cordura 500 D
BUOYANCY IN NEWTON							
XXS	-	-	-	70	-	80	80
XS	80	100	60	130	130	120	120
S	90	100	80	140	140	140	140
M	130	140	90	150	150	160	160
L	160	160	130	170	170	190	190
XL	190	-	160	200	200	220	220
XXL	-	-	-	200	-	220	220
TYPE OF BACKPLATE / CYLINDER FIXING	Rigid / Single strap	Soft / Double strap	Soft / Double strap	Rigid / Single strap	Rigid / Single strap	Rigid / Single strap	Rigid / Single strap
COMPATIBLE CYLINDERS LITRES - DIAMETER MM	MONO 10/12/15/18 - 171/203/216	MONO 10/12/15/18 - 171/203/216	MONO 10/12/15/18- 171/203/216	MONO 10/12/15/18- 171/203/216	MONO 10/12/15/18- 171/203/216	MONO 10/12/15/18- 171/203/216	MONO 10/12/15/18- 171/203/216
INTEGRATED WEIGHT POCKETS - MAX KG FOR POCKET	Flat lock aid - 4,5+4,5	Flat lock aid - 4,5+4,5	Flat lock aid - 4,5+4,5	Fixed gravity pocket - 2+2 (xxs, xs, s) / 3+3 (m, l, xl)	NO	Quick Lock System 2+2 (xxs) 1 4,5+4,5 (xs, s, m, l, xl, xxl)	NO
ABDOMINAL ADJUSTMENT	Standard waist band + buckle	Buckle + SPWB (self pivoting waistband) "B"	Standard waist band + buckle	Standard waist band + buckle	Standard waist band + buckle	Standard waist band + buckle	Standard waist band + buckle
STERNAL ADJUSTMENT	Fixed	Movable	Fixed	Fixed	Fixed	Fixed	Fixed
SHOULDER STRAP ADJUSTMENT	Standard	Standard	Standard	Standard	Standard	Standard	Standard
QUICK DUMP AND OVER-PRESSURE VALVES							
N°	2	2	2	2	2	2	2
DISCHARGE KNOB POSITION	At the back, lower right area At the front, upper right Area	At the back, lower right area At the front, upper right Area	At the front, lower right area At the front, upper right Area	At the back, lower right area At the front, upper right Area	At the back, lower right area At the front, upper right Area	At the back, lower right area At the front, upper right Area	At the back, lower right area At the front, upper right Area
TOTAL DUMP VALVES	4	4	4	4	4	4	4
N° CHARGE VALVES	2	2	2	2	2	2	2
TYPE OF CONTROL UNIT	FLAT	FLAT	FLAT	FLAT	FLAT	FLAT	FLAT
N° OF POCKETS	2	2	2	2	2	2	2
N° OF BACK POCKETS	2	-	2	-	-	-	-
N° OF "D" RINGS	8	6	6	6	4	3	3
B.C.D.W WEIGHT & TOTAL BALLAST THAT CAN BE USED (KG)							
XXS	-	-	-	2,4 - 4	-	2,6 - 4	2,1 - NO
XS	3,0 - 14	2,95 - 9	2,4 - 14	2,5 - 4	2,4 - NO	2,85 - 9	2,2 - NO
S	3,1 - 14	3 - 9	2,4 - 14	2,5 - 4	2,5 - NO	2,9 - 9	2,25 - NO
M	3,2 - 14	3,1 - 9	2,5 - 14	2,75 - 6	2,6 - NO	2,95 - 9	2,3 - NO
L	3,3 - 14	3,15 - 9	2,5 - 14	2,8 - 6	2,7 - NO	3 - 9	2,35 - NO
XL	3,4 - 14	-	2,6 - 14	2,9 - 6	2,8 - NO	3,1 - 9	2,4 - NO
XXL	-	-	-	2,9	-	3,11 - 9	n/a
WEARABILITY: CHEST (CM) - WAIST (CM) - WEIGHT (KG)							
XXS	-	-	-	70/85 70/80 48/60	-	70/85 70/80 48/60	70/85 70/80 48/60
XS	80/90 75/90 55/65	80/90 75/90 55/65	80/90 75/90 55/65	80/90 75/90 55/65	80/90 75/90 55/65	80/90 75/90 55/65	80/90 75/90 55/65
S	90/100 85/95 63/78	90/100 85/95 63/78	90/100 85/95 63/78	90/100 85/95 63/78	90/100 85/95 63/78	90/100 85/95 63/78	90/100 85/95 63/78
M	100/110 95/105 75/85	100/110 95/105 75/85	100/110 95/105 75/85	100/110 95/105 75/85	100/110 95/105 75/85	100/110 95/105 75/85	100/110 95/105 75/85
L	105/115 100/110 80/100	105/115 100/110 80/100	105/115 100/110 80/100	105/115 100/110 80/100	105/115 100/110 80/100	105/115 100/110 80/100	105/115 100/110 80/100
XL	115/125 110/120 110/120	-	115/125 110/120 110/120	115/125 110/120 110/120	115/125 110/120 110/120	115/125 110/120 110/120	115/125 110/120 110/120
XXL	-	-	-	125/130 120/130 120/125	-	125/130 120/130 120/125	125/130 120/130 120/125

DIVE TORCHES



Photo by: Fabio Rolteri & Giada Campanella

ASTRA 2100 NEW 2025

LED LIGHT TECHNOLOGY
PREMIUM MATERIALS

SCUBA DIVING LIGHT

Astra 2100 is the underwater torch that transforms every dive into an extraordinary visual experience. Equipped with an advanced CREE XHP50 LED, this torch not only illuminates the dark depths with 2000 lumens of power, but also enhances underwater colors, making every detail bright and vivid like never before. Ideal for underwater explorers, Astra allows you to discover the mysteries of the marine world in all their vibrant beauty.

With three lighting modes—100%, 50%, and strobe—suitable for every need, Astra ensures light duration from 4 to 7 hours, allowing for long underwater explorations. The heart of Astra beats thanks to a rechargeable 5000mAh lithium battery, which fully charges in just 3 hours through an innovative magnetic connector. This charging system is designed to withstand sand, salt, and other external agents, ensuring reliability and functionality under any condition.

Made from sturdy and lightweight aluminum alloy, with a reduced weight of 438 grams, Astra is as durable as it is manageable. Its IPX8 certified waterproof up to 100 meters and impact resistance from 1 meter make it the perfect ally for every dive.



TECHNICAL CHARACTERISTICS - ASTRA 2100

LED Chip:	CREE XHP50
Brightness:	100% - 1100 lm / 50% - 550 lm
Light Mode:	100% - 50% - Strobe
Runtime:	100% - 4 h / 50% - 7 h / Strobe - 5,5 h
Charging Time:	3 h
Color temp:	5700~7300 K
Beam Angle:	8,6°
Max Charge Current:	2000 mA
Beam Distance:	350 m - 230 m
Material:	Aluminum alloy
Waterproof:	IPX8 - 100 m
Battery:	5000 mAh
Impact resistance:	1m
Dimensions:	Ø52 x 177 mm
Net Weight:	438 g

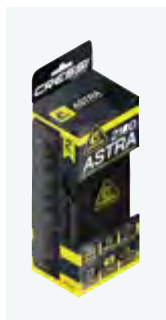

PRODUCT	CODE	RRP €
ASTRA 2100	SJ551250	149,99
CHARGER	SZ541200	39,99

ASTRA 1200 NEW 2025

LED LIGHT TECHNOLOGY
PREMIUM MATERIALS

SCUBA DIVING LIGHT

Astra 1200 is a compact and lightweight diving torch that delivers an exceptional visual experience during dives. Equipped with a CREE XPL2 LED, this torch illuminates the underwater world with 1200 lumens, enhancing color perception and making every detail sharp and vivid. It's ideal for marine exploration enthusiasts who want a handy yet powerful torch.

It offers three lighting modes—100%, 50%, and strobe—that adapt to various underwater conditions, with battery life ranging from 3 to 5 hours depending on the mode used, thus allowing for extended dives. The Astra 1200 recharges in 4 hours via a magnetic connector that resists external agents such as sand and salt.

Constructed from aluminum alloy, it weighs only 240 grams, making it extremely lightweight and easy to handle. Certified IPX8, it can be submerged up to 100 meters and withstands impacts from 1 meter, ensuring reliability and durability.



TECHNICAL CHARACTERISTICS - ASTRA 1200

LED Chip:	CREE XPL2
Brightness: 100%:	100% - 1100 lm / 50% - 550 lm
Light Mode:	100% - 50% - Strobe
Runtime:	100% - 3 h / 50% - 5 h / Strobe: 4,5 h
Charging Time:	4 h
Color temp:	5700~7300 K
Beam Angle:	8,6°
Max Charge Current:	1000 mA
Beam Distance:	250 m - 170 m
Material:	Aluminum alloy
Waterproof:	IPX8 - 100 m
Battery:	2600 mAh
Impact resistance:	1m
Dimensions:	Ø41,5 x 149 mm
Net Weight:	240 g



PRODUCT	CODE	RRP €
ASTRA 1200	SJ551150	129,99
CHARGER	SZ541200	39,99

HUNT

NEW 2025

BEAM OVER 290 METERS

PREMIUM MATERIALS

INTEGRATED GRIP

WHITE COLOR TEMPERATURE

EXCELLENT ERGONOMICS

3 HOURS OF CONTINUOUS OPERATION

SPEARFISHING LIGHT

The Hunt torch, specifically developed for spearfishing, combines power and functionality in an ergonomically advanced design. Equipped with a Luminus SST40 LED, it emits a brightness of 1600 lumens and a light beam that reaches over 290 meters (in the air), perfect for environments with limited visibility.

The ergonomic design is enhanced by a curved profile that ensures a comfortable and secure grip, further improved by an integrated grip and anti-slip button, ideal for intuitive use even with diving gloves. This allows the diver to activate the light only when necessary, thereby maximizing battery life and minimizing the risk of startling fish. The

torch is made from high-quality materials that not only provide robustness and impact resistance up to 1.5 meters but also ensure waterproofness up to 100 meters deep (IPX8). It features a built-in 5000 mAh battery, rechargeable through an innovative magnetic USB connector. This charging solution is particularly advantageous as it prevents the entry of sand, salt, or dust into the connection components, ensuring greater reliability and ease of maintenance. The torch promises up to 2 hours of continuous operation, making it an essential accessory for every spearfishing enthusiast.



BLACK



CAMOU

TECHNICAL CHARACTERISTICS

LED Chip:	Luminus SST40
Brightness:	1600 lm
Runtime:	2 h
Charging Time:	4.5 h
Color temp:	5700-7300 K
Beam Angle:	11°
Max Charge Current:	2000 mA
Beam Distance:	290 m
Material:	Aluminum alloy - Polycarbonate
Waterproof:	IPX8 - 100 m
Battery:	5000 mAh
Impact resistance:	1.5 m
Dimensions:	Ø 38 x 161 mm
Net Weight:	196 g

HUNT

HIGH RANGE COLOR SPECTRUM



STANDARD LIGHT

LIMITED RANGE COLOR SPECTRUM



PRODUCT	CODE	RRP €
HUNT TORCH 1600 BLACK	SJ552050	99,99
HUNT TORCH 1600 CAMOUFLAGE	SJ552077	99,99
CHARGER - MAGNETIC	SZ541200	39,99

LUMIA+

ULTRA LED DIVE LAMP

- WHITE COLOR TEMPERATURE
- ADJUSTABLE ELASTIC STRAP
- EXCELLENT ERGONOMICS
- SWITCH WITH 3 POSITIONS
- LED LIGHT TECHNOLOGY
- PREMIUM MATERIALS
- NARROWED LIGHT BEAM

Torch with a highly asymmetric design boasts excellent ergonomics and a highly tactile perception of its geometric characteristics. Thanks to this particular design, the switch position is immediately found without needing to use your eyesight. The porthole and body are coated with thermoplastic rubber to extend shelf life and reduce noises from impact when used for fishing. These ergonomic features are a big advantage over aluminium torches with a circular section which do not give feedback on the position of the grip and, in some cases, even require the use

of two hands to turn it on. The switch has three positions: Off. On Unstable with Automatic Return, On. The "On Unstable" position is particularly useful in fishing because it allows flashing by one simple press. The strap with slider spring allows adjustment according to the user's needs, but being elastic can be pulled out in case of emergency. Power is supplied by four AA "Stylus" batteries, either alkaline or rechargeable. The electronics ensure a constant level of brightness even when the batteries are rechargeable and/or not fully charged. Batteries included.

Length	168 mm - 6.61 inch
Head diameter	47 mm - 1.85 inch
Weight	130 gr - 4.58 OZ (without batteries)

NEW WHITE COLOR TEMPERATURE

The LED has a white color temperature similar to sunlight for maximum return of the colors in the underwater environment. The light beam of the LED is narrowed into a spot light beam of about 6° by means of a lens made of ultra-transparent material protected by the polycarbonate optical porthole.

ACTIVE ELECTRONICS

Power is supplied by four AA "Stylus" batteries, either alkaline or rechargeable. The power supply has an electronic management system that eliminates the gap between the different electrical potentials of different types of batteries and ensures an efficiency of 30% higher than the commonly used systems. The active electronics of the flashlight guarantee constant light, even when the battery charge decreases. When the charge drops below the safety threshold value, the lighting level will reduce to warn the user that the batteries are depleted.

TECHNICAL CHARACTERISTICS

Luminous Flux	300 Lumens
Lumen Output	6500 °K CRI>75
Burn Time	3,5 h
Viewing Angle	6°
Illuminance	30000 Lux
Impact Resistance	1,5 m
Ingress Protection Code	IPX-8 75m

LUMIA +

HIGH RANGE COLOR SPECTRUM



STANDARD LIGHT

LIMITED RANGE COLOR SPECTRUM

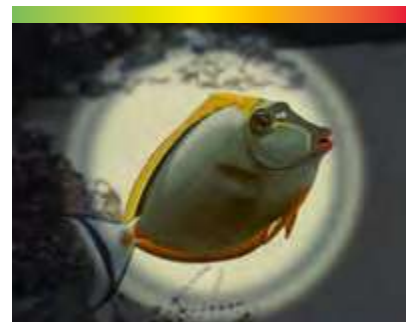

EXCELLENT ERGONOMICS

THANKS TO THERMOPLASTIC RUBBER COATING AND HIGHLY ASYMMETRIC DESIGN

SWITCH WITH 3 POSITIONS

OFF ; ON UNSTABLE WITH AUTOMATIC RETURN ; ON

NARROWED LIGHT BEAM

APPROXIMATELY 6° SPOT LIGHT BEAM THANKS TO TIR LENS

ADJUSTABLE ELASTIC STRAP

TO CUSTOMISE THE USAGE ACCORDING TO YOUR NEEDS

NEUTRAL WHITE COLOR TEMPERATURE

SIMILAR TO SUNLIGHT FOR MAXIMUM RETURN OF THE COLORS

NEW
WHITE COLOR
LED LIGHT



BLACK/SILVER



BLACK/BLACK

PRODUCT	CODE	RRP €
LUMIA+ TORCH BLACK/SILVER	SJ550170	79,99
LUMIA+ TORCH BLACK/BLACK	SJ550150	79,99



ORCA

STAINLESS STEEL

This legendary product has been around for years and years and has now become a sought-after collector's item. It is considerably heavy and large, perfect for a work tool, which this knife is designed to be. The large blade is forged from special steel, with a smooth edge on one side and partly serrated on the other. This side of the blade has a line cutter at the handle end. The anatomical, non-slip handle is made from soft grip material for a comfortable grip and comes with anatomical moulding for the fingers to fit into. On the back, it ends with a chrome-plated knob that can also be used as a mallet. The front of the handle ends with a stainless steel hilt to protect the fingers. The sheath is made from plastic and has a traditional elastic band to hold on the knife. It also has loops to attach the knife to your leg or onto your belt and comes with two leg straps.



Blade length	17,8 cm - 7.01 inch
Total length	30 cm - 11.82 inch
Blade width	32 mm - 1.25 inch
Blade thicknesses	5,5 mm - 0.22 inch
Knife-only weight	450 gr - 0.99 lb
Weight with sheath	600 gr - 1.32 lb

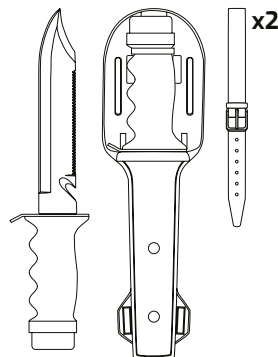

Photo by: Andrea Settini

CODE		RRP €
RC556000		109,99

BORG

STAINLESS STEEL 420

Borg is a modern, large knife with a futuristic design and a strong, tempered blade. One side of the stainless steel blade is straight-edged, the other one is serrated right along the blade; they are both very sharp and effective for line cutting.

Sheath with locking mechanism to allow one-hand release. It is separated from the blade by a small technopolymer thumb tab. The knife comes with two, standard issue straps to attach it to your leg.



Blade length	14,5 cm - 5.7 inch
Total length	26.8 cm - 10.5 inch
Blade width	25 mm - 1 inch
Blade thicknesses	5 mm - 0.19 inch
Knife-only weight	230 gr - 0.5 lb
Weight with sheath	330 gr - 0.72 lb

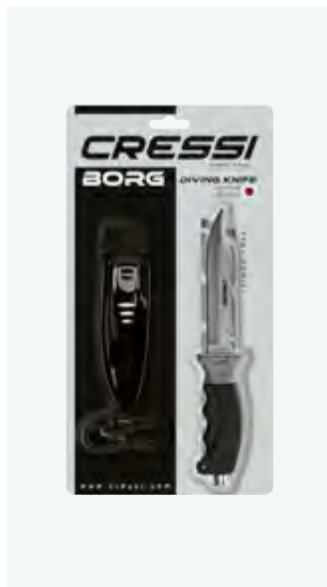
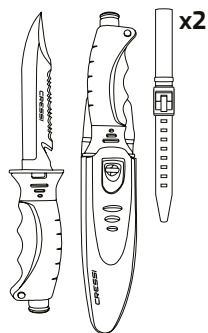

CODE		RRP €
RC559100		74,99

SKORPION

STAINLESS STEEL 420

Skorpion is a modern, medium-sized knife with a futuristic design and a strong, tempered blade.

One side of the stainless steel blade is straight-edged, the other one is serrated right along the blade; they are both very sharp and effective for line cutting. It is separated from the blade by a small technopolymer thumb tab.

Sheath with locking mechanism to allow one-hand release. The knife comes with two, standard issue straps to attach it to your leg.



Blade length	11 cm - 4.33 inch
Total length	23.5 cm - 9.25 inch
Blade width	25,5 mm - 10,03 inch
Blade thicknesses	5 mm - 0.18 inch
Knife-only weight	200 gr - 0.3 lb
Weight with sheath	280 gr - 0.55 lb

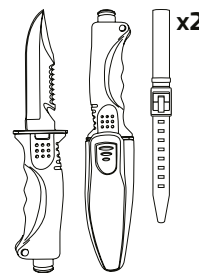

CODE		RRP €
RC559000		64,99



KAI

STAINLESS STEEL W 1.4060 + COATING

Italian-made professional diver's knife, with blade and handle in W 1.4060 martensitic stainless steel, hardness HRC 55/56, for an extremely sharp and honed blade. It has a V-shaped cross section blade and is equipped with a saw, a line cutter and a loop for the leash. The Idrogliider Gold Black surface treatment increases resistance to corrosion in marine environments. Equipped with a 1000 D ballistic nylon sheath and neoprene legbands and armbands in several sizes to perfect fits.



Blade length	10 cm - 3.9 inch
Total length	23 cm - 9 inch
Blade width	30 mm - 1.2 inch
Blade thicknesses	4 mm - 0.15 inch
Knife-only weight	140 gr - 0.3 lb
Weight with sheath	180 gr - 0.39 lb

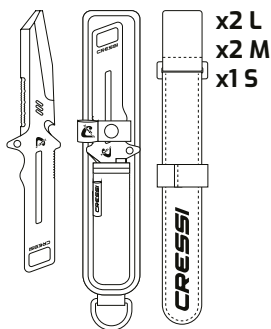

CODE	RRP €
RC559510	54,99

ARGUS

NEW 2025

STAINLESS STEEL 420

Cressi Argus is designed specifically for scuba diving enthusiasts. With its impressive features and durable construction, it's the perfect choice for your underwater adventures. The knife boasts an overall length of 26.8 cm, providing optimal reach and maneuverability in various underwater scenarios. The blade itself measures 13.8 cm in length and is crafted from high-quality 420 stainless steel, ensuring exceptional corrosion resistance and long-lasting sharpness. The knife's sheath is made from matte ABS, a rugged and lightweight material that offers reliable protection for the blade when not in use. The handle is constructed from a combination of ABS and TPR, providing a comfortable and secure grip even in wet or slippery conditions. For added convenience and versatility, Argus comes with two additional knife straps made from durable rubber. These straps securely fasten the knife to your gear, ensuring quick and easy access whenever you need it during your dive.



Blade length	13,8 cm - 5,3 inch
Total length	26,8 cm - 10,5 inch
Blade width	2,7 cm - 1 inch
Blade thicknesses	3,5 mm - 0,13 inch
Knife-only weight	550 gr - 1,2 lb
Weight with sheath	590 gr - 1,3 lb

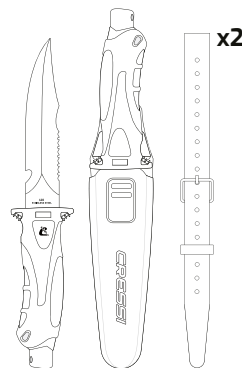

CODE	RRP €
RC560367	54,99

ARGUS SB

NEW 2025

STAINLESS STEEL 420

Argus SB is the shorter version of the Argus Knife. This compact and versatile knife offers exceptional features and robust construction, making it an indispensable tool for your underwater explorations. Argus SB features a shorter blade, the length is 9.8 cm for a total length of 22.8 cm. Crafted from high-quality 420 stainless steel, the blade ensures remarkable resistance to corrosion and maintains its sharpness even in challenging underwater conditions. Equipped with a matte ABS sheath, the handle is constructed from a combination of ABS and TPR materials, providing a comfortable and secure grip.

For added convenience, the Argus SB Dive Knife comes with two durable rubber knife straps. With its compact dimensions and great performance, the Argus SB proves to be an essential tool to enjoy your dives with unwavering confidence.



Blade length	9,5 cm - 3.7 inch
Total length	22,8 cm - 8.9inch
Blade width	2,5 cm - 1 inch
Blade thicknesses	3,5 mm - 0.13 inch
Knife-only weight	500 gr - 1.1 lb
Weight with sheath	515 gr - 1.1 lb

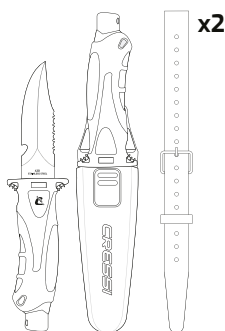

CODE		RRP €
RC560467		49,99

KAI MINI

STAINLESS STEEL W 1.4060 + COATING

Italian-made professional diver's compact multitool, with blade and handle in W 1.4060 martensitic stainless steel, hardness HRC 55/56, for an extremely sharp and honed blade. It has a V-shaped cross section blade and is equipped with a saw, a line cutter, a bottle opener and a loop for the leash.

The Idroglider Gold Black surface treatment increases resistance to corrosion in marine environments.

Equipped with a 1000 D ballistic nylon sheath and neoprene leg bands and armbands in several sizes to perfect fits.



Blade length	4,5 cm - 1.77 inch
Total length	11 cm - 4.33 inch
Blade width	30 mm - 1.2 inch
Blade thicknesses	4 mm - 0.15 inch
Knife-only weight	65 gr - 0.14 lb
Weight with sheath	90 gr - 0.19 lb

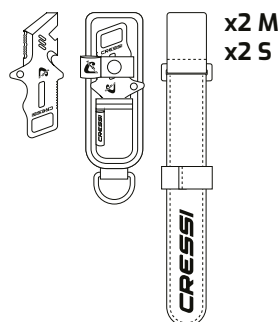

CODE		RRP €
RC559500		44,99



SUPERTOTEM

STAINLESS STEEL

An inexpensive, average-size knife with an excellent quality-price ratio. One side of the stainless steel blade is straight-edged, the other one is serrated right along the blade; they are both very sharp and effective for line cutting. The anatomic grip is made from technopolymers and has a series of moulds for the fingers, ending with a thumb protection tab at the blade end. The plastic sheath holds the knife firmly with a traditional elastic band and has loops to attach it to the leg or strap. The knife comes with two, standard issue straps to attach it to your leg.



Blade length	12.4 cm - 4.89 inch
Total length	23.2 cm - 9.14 inch
Blade width	32 mm - 1.25 inch
Blade thicknesses	3 mm - 0.12 inch
Knife-only weight	120 gr - 0.26 lb
Weight with sheath	210 gr - 0.46 lb

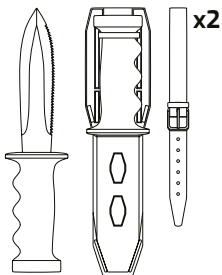

CODE		RRP €
RC550000		39,99

ALLIGATOR KNIFE/ SCISSORS

STAINLESS STEEL 420

Knife-scissors very practical for all types of operations underwater. Made of high-strength stainless steel, it is helpful as scissors, as a knife with a smooth edge blade, or as a saw blade, and also has a valuable recess as a wire cutter. Includes serration for use as pliers. Compared to other similar knives, it has the advantage of its contained size and its full use and ergonomics without having to open it to cut efficiently using it as a knife. Excellent cutting capacity and oxidation resistance.



Blade length	8.6 cm - 3.38 inch
Total length	17.5 cm - 6.88 inch
Blade width	26 mm - 1.02 inch
Blade thicknesses	6 mm - 0.23 inch
Knife-only weight	125 gr - 0.27 lb
Weight with sheath	164 gr - 0.36 lb

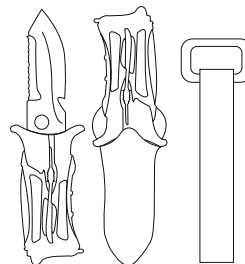

CODE		RRP €
RC559200		99,99

LINE CUTTER WITH POUCH

STAINLESS STEEL

The Line Cutter is a simple yet effective line cutting tool with a safety blade design. It can be used with one hand. This cutter is very convenient to carry, as it 176 mm long, with a 36 mm blade. It comes in a 60 by 90 mm case. Its sheath can be mounted on a harness rig or on a BCD. It comes with Velcro attached to the strap of the blade, in addition to a case with Velcro that can be attached to harnesses and belts.



Blade length	3,6 cm - 1,4 inch
Total length	17,5 cm - 6,88 inch
Blade width	n.a.
Blade thicknesses	n.a.
Knife-only weight	n.a.
Weight with sheath	n.a.



CODE		RRP €
RC560200		25,99

HAKA SCISSORS

NEW 2025

STAINLESS STEEL

Expertly crafted from stainless steel, these scissors ensure resilience in challenging underwater conditions. The blade design guarantees precision, making them reliable for any diving scenario. With a purpose-built sheath for convenient storage and quick access, the Haka scissors are designed for ease. The secure grip handles facilitate easy and precise cutting, even with gloves on, enhancing the overall diving experience and promoting safety for every diver. The Haka is your commitment to responsible diving and preserving our precious aquatic environments.



Blade length	n.a.
Total length	34,3 cm - 14 inch
Blade width	n.a.
Blade thicknesses	n.a.
Knife-only weight	90,7 gr - 3 oz
Weight with sheath	n.a.



CODE		RRP €
RC580050		19,99



LIZARD SPECIALIZED

STAINLESS STEEL W 1.14116

Italian-made professional, multipurpose diver's knife, with blade and handle in 1.14116 martensitic stainless steel, hardness HRC 55/56, for an extremely sharp and honed blade. A knife with a dagger handle designed specifically for fishing. In the body of the knife a part is intended for the extraction of stranded shafts and for straightening them. The knife can be removed from its sheath quickly and with one hand thanks to a special mechanical system.

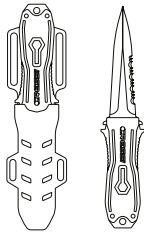

Blade length	10,5 cm - 4.13 inch
Total length	21 cm - 8.26 inch
Thickness blade	3.8 mm - 0.15 inch



PRODUCT	CODE	RRP €
LIZARD KNIFE BLACK	RC559600	79,99
LIZARD KNIFE RED	RC559680	79,99
LIZARD KNIFE GREEN	RC559690	79,99

SNAKE SPECIALIZED

STAINLESS STEEL W 1.14116

Easy to pull out and reinsert into the sheath, it can be done without having to look.

The Snake's blade is designed to offer a perfect balance between edge retention and corrosion resistance. This means you can count on a sharp and durable blade that will maintain its edge over time and withstand the most adverse conditions. The Snake's main innovation is its quick release and rod catcher integrated into the handle. This feature allows the knife to be pulled out and stored quickly and effortlessly, offering greater convenience and safety during use. In addition, the integrated rod breaker makes it easy to break glass in emergency situations, making the Snake a versatile and reliable knife in a variety of circumstances.



Blade length	8.1 cm - 3.18 inch
Total length	18.6 cm - 7.3 inch
Thickness blade	3.8 mm - 0.14 inch

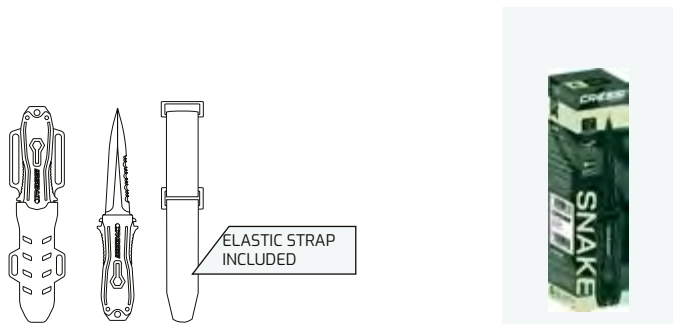

CODE	RRP €
RC559850	69,99

PREDATOR

STAINLESS STEEL 420 + COATING

Small stiletto knife, designed for underwater fishing. Manageable, blade penetration and durability and grip. The blade extends through the interior of the handle and, at the end of the handle, has a small pommel. Tempered AISI 420 steel with Black Coating. The duration of these features is guaranteed not by the sharpness itself, but by the quality of the material that guarantees the durability of the blade. Rhomboidal cross section for greater resistance to flexing and breaking. Double-edged blade with one smooth-edged side and the other serrated. Comfortable handle with rubbery polymer coating.



Blade length	8.6 cm - 3.39 inch
Total length	18 cm - 7.1 inch
Blade width	17 mm - 0.67 inch
Blade thicknesses	3-5 mm - 0.1-0.2 inch
Knife-only weight	120 gr - 0.26 lb
Weight with sheath	200 gr - 0.44 lb

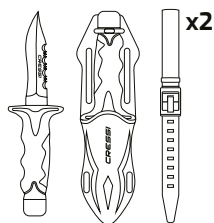

CODE		RRP €
RC554500		69.99

FINISHER

STAINLESS STEEL 304 + COATING

Medium-sized stiletto knife designed for underwater fishing. Manageable, high blade penetration and durability with a secure grip. The blade extends through the interior of the handle and, at the end of the handle, has a small pommel. Tempered AISI 304 steel with Black Coating. The duration of these features is guaranteed not by the sharpness itself, but by the quality of the material that guarantees the durability of the blade. Rhomboidal cross section for greater resistance to flexing and breaking. Double-edged blade with one smooth-edged side and the other serrated. Comfortable handle with rubbery polymer coating.



Blade length	12.7 cm - 5 inch
Total length	24.7 cm - 9.7 inch
Blade width	17 mm - 0.67 inch
Blade thicknesses	3-5 mm - 0.1-0.2 inch
Knife-only weight	130 gr - 0.28 lb
Weight with sheath	200 gr - 0.44 lb

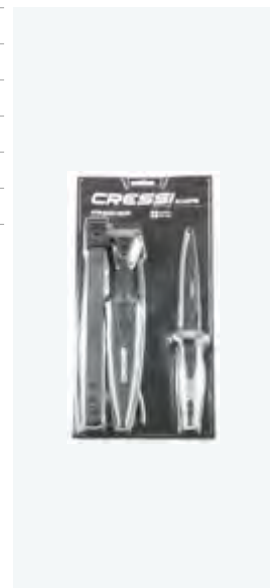
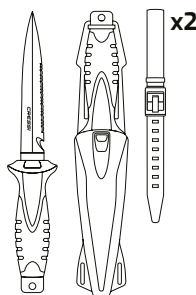

CODE		RRP €
RC559300		79.99

VIGO

STAINLESS STEEL

Blades are made from stainless steel specifically made for the marine environment.
 Sheath with locking mechanism to allow one-hand release.
 The knife comes with two, standard issue straps to attach it to your leg



Blade length	11,8 cm - 4.6 inch
Total length	23,5 cm - 9.2 inch
Blade width	25,2 mm - 1 inch
Blade thicknesses	5 mm - 0.19 inch
Knife-only weight	147 gr - 0.32 lb
Weight with sheath	217 gr - 0.47 lb

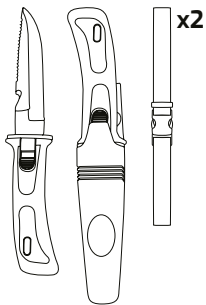

CODE		RRP €
RC555000		27,99

KILLER

STAINLESS STEEL

A small knife that's been around for years now, highly appreciated because it is easy to handle and the blade penetrates really well. This is forged from a single piece of stainless steel, and is blocked at the grip by a screw knob situated at the end of the grip. One side of the blade has a smooth cutting edge, the other is partly serrated.
 The anatomical technopolymer grip ends at the blade with a thumb tab. The sheath is made from plastic and has a traditional elastic band to hold on the knife and loops to attach the knife to your leg or onto your belt.
 The knife comes with two, standard issue straps to attach it to your leg.



Blade length	8,6 cm - 3.39 inch
Total length	18 cm - 7.09 inch
Blade width	25,2 mm - 1 inch
Blade thicknesses	3-5 mm - 0.12-0.2 inch
Knife-only weight	120 gr - 0.26 lb

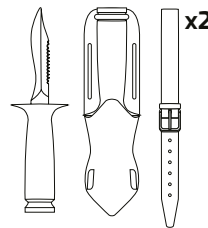

CODE		RRP €
RC554000		59,99

STRIKER

STAINLESS STEEL 420

NEW 2025

The Striker dive knife is designed to offer maximum strength and functionality, essential for every diver. Made of grade 420 stainless steel, it guarantees durability and corrosion resistance. The one-piece design includes a double-edged blade, excellent for cutting various materials underwater. The Striker features a low-profile case with a safety mechanism that prevents leakage but allows quick access to the knife when needed. Innovative is the integration of specific tools such as the extraction and straightening of underwater fishing rods, useful for dealing with complex situations while diving. Complemented by a robust strap and the ability to be mounted on a weight belt, the Striker proves to be a versatile and reliable diving tool, ready to face any challenge in the marine environment.



Blade length	9 cm - 3.54 inch
Total length	22 cm - 8.66 inch
Blade width	2,5 cm - 0.98 inch
Blade thicknesses	2 mm - 0.07 inch
Knife-only weight	774 gr - 1.6 lb
Weight with sheath	n.a.

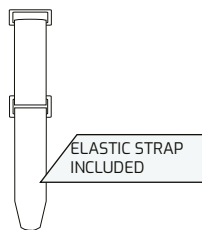

CODE		RRP €
RC560080		54,99

GRIP

STAINLESS STEEL 304

The Grip Spear is a small-sized knife with a tapered blade that makes it ideal for spearfishing. The blade is made in stainless steel. It features a high precision dagger point tip. One side is an extra rigid serrated blade for sawing, the other side is a skillfully crafted straight blade. It features an ergonomic non-slip handle grip and a hole to add a lanyard (not included). The knife comes with a sheath that can be attached to the BCD shoulder strap. The sheath has a locking mechanism that prevents the knife from falling out. With 2 rubber straps (included) you can fix the sheath to your leg or your arm. The straps are 20 in (50.8 cm) long. Great for spear fishing or scuba diving; as primary knife or back-up.



Blade length	8,1 cm - 3.1 inch
Total length	17,4 cm - 6.8 inch
Knife-only weight	49 gr - 0.1 lb
Weight + sheath	85 gr - 0.18 lb

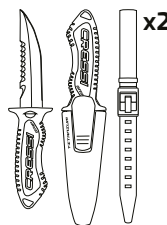

CODE		RRP €
RC559400		44,99

CHAKU NEW 2025

MULTI BLADE OPTIONS

Introducing the Chaku dive knife - the ultimate foldable-blade solution for scuba diving and spearfishing. The blade can be folded manually by pressing the upper lever. Engineered for versatility, its razor-sharp stainless steel flip blade effortlessly handles lines, nets, and vegetation. The wrist strap ensures secure accessibility, adding an extra layer of safety during dives. With dual serrated and smooth blade options, this compact and streamlined knife offers efficient maneuverability without compromising power.



Blade length	n.a.
Total length	17.1 cm - 7 inch
Blade width	n.a.
Blade thicknesses	n.a.
Knife-only weight	113.4 gr - 4 oz
Weight with sheath	n.a.

COLOR	CODE	RRP €
CHAKU KNIFE BLUE	RC570020	29,99
CHAKU KNIFE w/BLACK ELECTRO-PLATING BLACK	RC570050	39,99
CHAKU KNIFE TITANIUM/BLACK	RC570072	59,99
CHAKU KNIFE ORANGE	RC570085	29,99

SILICONE GREASE

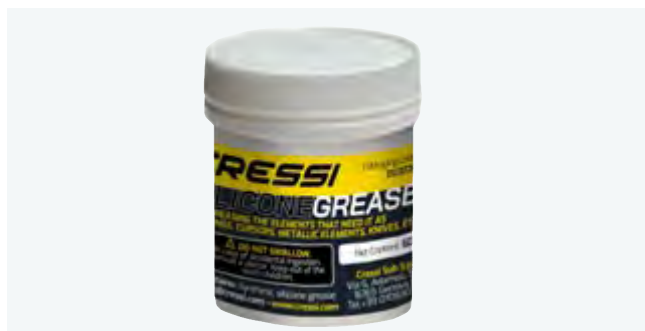

PRODUCT	CODE	RRP €
SILICONE GREASE	HZ704060	11,99

MAIN KNIVES SPARE PARTS

PRODUCT	CODE	RRP €
KAI KNIFE SHEATH NYLON	RZ559500	14,50
KNIFE BLACK STRAPS (2pcs)	RZ550097	10,5
HOLDER KILLER KNIFE	RZ550008	4,99
HOLDER SUPERTOTEM/ORCA	RZ551007	4,99
SHEATH + STRAPS ORCA	RZ550003	24,99
SHEATH + STRAPS KILLER	RZ550006	15,99



Photo by: Lorenzo Mittiga

KNIVES COMPARISON TABLE

SCUBA KNIVES



PRODUCT	BLADE LENGTH	TOTAL LENGTH	BLADE WIDTH	BLADE THICKNESSES	KNIFE-ONLY WEIGHT	WEIGHT WITH SHEATH
ARGUS	13.8 cm 5.3 inch	26.8 cm 10.5 inch	2.7 cm 1 inch	3.5 mm 0.13 inch	550 gr 1.2 lb	590 gr 1.3 lb
ARGUS SB	9.5 cm 3.7 inch	22.8 cm 8.9 inch	2.5 cm 1 inch	3.5 mm 0.13 inch	500 gr 1.1 lb	515 gr 1.1 lb
KAI	10 cm 3.9 inch	23 cm 9 inch	30 mm 1.2 inch	4 mm 0.15 inch	140 gr 0.3 lb	180 gr 0.39 lb
KAI MINI	4.5 cm 1.77 inch	11 cm 4.33 inch	30 mm 1.2 inch	4 mm 0.15 inch	65 gr 0.14 lb	90 gr 0.19 lb
ORCA	17.8 cm 7.01 inch	30 cm 11.82 inch	32 mm 1.25 inch	5.5 mm 0.22 inch	450 gr 0.99 lb	600 gr 1.32 lb
BORG	14.5 cm 5.7 inch	26.8 cm 10.5 inch	25 mm 1 inch	5 mm 0.19 inch	230 gr 0.5 lb	330 gr 0.72 lb
NORGE	11.7 cm 4.61 inch	22.8 cm 8.98 inch	25 mm 1 inch	4.5 mm 0.18 inch	140 gr 0.3 lb	250 gr 0.55 lb
SKORPION	11 cm 4.33 inch	23.5 cm 9.25 inch	25.5 mm 10.03 inch	5 mm 0.18 inch	200 gr 0.3 lb	280 gr 0.55 lb
SUPERTOTEM	12.4 cm 4.89 inch	23.2 cm 9.14 inch	32 mm 1.25 inch	3 mm 0.12 inch	120 gr 0.26 lb	210 gr 0.46 lb
ALLIGATOR	8.6 cm 3.38 inch	17.5 cm 6.88 inch	26 mm 1.02 inch	6 mm 0.23 inch	125 gr 0.27 lb	164 gr 0.36 lb

SPEARFISHING KNIVES



PRODUCT	BLADE LENGTH	TOTAL LENGTH	BLADE WIDTH	BLADE THICKNESSES	KNIFE-ONLY WEIGHT	WEIGHT WITH SHEATH
LIZARD	10.5 cm 4.13 inch	21 cm 8.26 inch	n/a	3.8 mm 0.15 inch	128 gr 0.28 lb	160 gr 0.35 lb
SNAKE	8.1 cm 3.18 inch	18.6 cm 7.3 inch	n/a	3.8 mm 0.14 inch	110 gr 0.24 lb	135 gr 0.29 lb
PREDATOR	8.6 cm 3.39 inch	18 cm 7.1 inch	17 mm 0.67 inch	3-5 mm 0.1-0.2 inch	120 gr 0.26 lb	200 gr 0.44 lb
FINISHER	12.7 cm 5 inch	24.7 cm 9.7 inch	17 mm 0.67 inch	3-5 mm 0.1-0.2 inch	130 gr 0.28 lb	200 gr 0.44 lb
VIGO	11.8 cm 4.6 inch	23.5 cm 9.2 inch	25.2 mm 1 inch	5 mm 0.19 inch	147 gr 0.32 lb	217 gr 0.47 lb
KILLER	8.6 cm 3.39 inch	18 cm 7.09 inch	25.2 mm 1 inch	3-5 mm 0.1-0.2 inch	120 gr 0.26 lb	n/a
STRIKER	9 cm 3.54 inch	22 cm 8.66 inch	2.5 cm 0.98 inch	2 mm 0.07 inch	774 gr 1.6 lb	n/a
GRIP POINT TIP	8.1 cm 3.1 inch	17.4 cm 6.8 inch	n/a	n/a	49 gr 0.1 lb	85 gr 0.18 lb
CHAKU	n/a	17.1 cm 7 inch	n/a	n/a	113.4 gr 4 oz	n/a





DRYSUITS & WEETSUITS

GLACIER SPECIALIZED

THICKNESS
4 MM HIGH DENSITY

ANTI-ABRASION
X-DIAMOND PADS

ADDITIONAL PROTECTIVE
NEOPRENE COLLAR

CE CERTIFICATION
DIVING WETSUIT
EN 14225-2:2017



HIGH DENSITY 4 mm DRYSUIT

Glacier is a 4mm precompressed high-density neoprene, heavy duty, dry-suit. The main feature of Glacier is its collar and wrist sealing. It is made of latex. This ensures the best adherence possible to your body and minimizes the chance of water leaking in the suit. Both collar and wrist sealing are customizable. Have them cut to your precise size to have a perfect fit. Collar and wrists are replaceable too, in case they wear out or

accidentally tear. Glacier features a second 1.5 mm neoprene collar, for additional thermal protection. Shoulders, back, hips and knees are reinforced with X-Diamond pad material, making this dry-suit very resistant to abrasion. The feet are made of soft and elastic neoprene for a comfortable fit. Inside the dry-suit a pair of suspenders will hold the suit in place when it is open. The zip is covered by a neoprene flap.

The charging valve is activated by a side button, while the deflating valve is adjustable. Glacier features two large pockets on the sides of the legs to comfortably place the additional gear you want to carry with you underwater.



LATEX COLLAR
+
ADDITIONAL THERMIC
NEOPRENE COLLAR

LONG-LASTING
X-DIAMOND PAD
(SHOULDERS, UPPER
BACK, HIPS, LOWER
BACK AND KNEES)



LATEX CUFFS

DOUBLE STORAGE
POCKETS

SOFT NEOPRENE
SOCKS

TECHNICAL FEATURES

- 4 mm High-density prestressed neoprene (external / internal nylon)
- Double storage pocket (one on the right and one on the left)
- Latex collar and cuffs
- Additional 1.5 mm neoprene thermal protection collar
- Shoulders, upper back, hips and lumbar area, knees with the special anti-abrasion X-Diamond Pad lining.
- Soft neoprene boots
- Internal braces
- Zipper flap
- Side-operated swivel fill valve
- Adjustable discharge relief valve

LATEX COLLAR + THERMIC NEOPRENE COLLAR

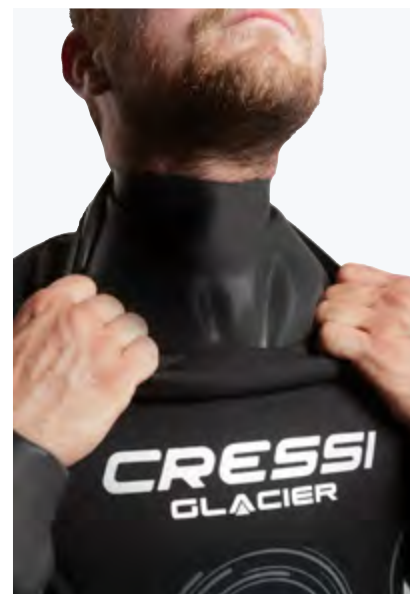

PRODUCT	THK	SIZE	CODE	RRP €
GLACIER DRY SUIT	4 mm	MAN S/2	LQ401302	1199,99
GLACIER DRY SUIT	4 mm	MAN M/3	LQ401303	1199,99
GLACIER DRY SUIT	4 mm	MAN L/4	LQ401304	1199,99
GLACIER DRY SUIT	4 mm	MAN XL/5	LQ401305	1199,99
GLACIER DRY SUIT	4 mm	MAN 2L/6	LQ401306	1199,99
GLACIER DRY SUIT	4 mm	MAN 3XL/7	LQ401307	1199,99
GLACIER DRY SUIT	4 mm	LADY XS/1	LQ401401	1199,99
GLACIER DRY SUIT	4 mm	LADY S/2	LQ401402	1199,99
GLACIER DRY SUIT	4 mm	LADY M/3	LQ401403	1199,99
GLACIER DRY SUIT	4 mm	LADY L/4	LQ401404	1199,99
GLACIER DRY SUIT	4 mm	LADY XL/5	LQ401405	1199,99
INFLATAION HOSE + OR FOR DRY SUIT (86cm)			LZ750038	41,99

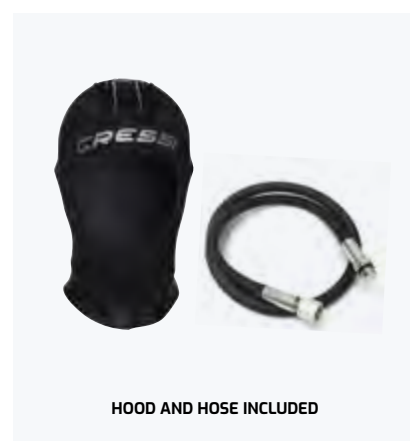

HOOD AND HOSE INCLUDED

DESERT

HIGH DENSITY 4 mm DRYSUIT

THICKNESS
4 MM HIGH DENSITY

METALLIC
BACK ZIP

HIGH STRETCH
SPANFLEX MATERIAL

LIQUID SEAL
TECHNOLOGY

CE CERTIFICATION
DIVING WETSUIT
EN 14225-2:2017



Comfortable and resistant thanks to its 4mm thick High-Density pre-compressed neoprene dry suit and Liquid Seal protected stitched joints. The seams and outer neoprene lining are covered with a special layer of elastomer so as to simultaneously create an impermeable obstacle for the water and increased resistance at the joints. On the inside, an additional sealing strip guarantees total waterproof-ability. This

double sealing system has been carefully designed to meet the needs of the most discerning and seasoned divers that often require their dry suits to be able to adapt to extreme working or weather conditions. The special Spanflex material has also been used in the outer part so as to increase elasticity and abrasion resistance. The cuffs are made of smooth 3,5 mm-thick neoprene on the inside in order to improve sealability and from

Ultraspan on the outside in order to improve elasticity. The collar is made of the same materials but with 2,5mm-thick neoprene for more comfort and breathability when turned-up. The shoulder neck and knee lines are reinforced with a special anti-abrasion X-Diamond Pad lining. The suit comes with a practical multipurpose pocket placed on the right leg as well as a comfortable hood.

TECHNICAL FEATURES

- 4 mm-thick High-Density pre-compressed neoprene.
- Soft neoprene socks.
- Internal suspender system.
- Fly with concealed zip.
- Heavy duty kneepads
- Side action rotating inflation valve.
- Adjustable discharge relief valve.

LIQUID SEAL TECHNOLOGY

A layer of polymer is spread along the seams to protect and seal them, thereby increasing the resistance to wear, the lifetime of the suit, and its insulating power.

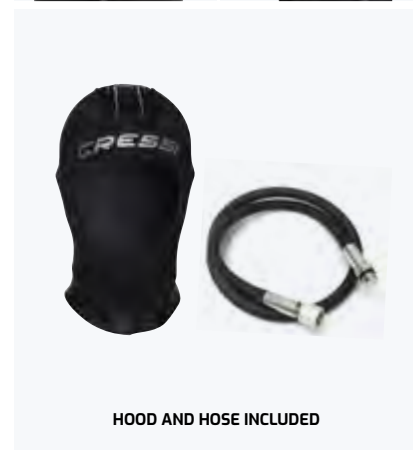

HOOD AND HOSE INCLUDED

PRODUCT	THK	SIZE	CODE	RRP €
DESERT DRY SUIT HD	4 mm	MAN S/2	LQ401002	999,99
DESERT DRY SUIT HD	4 mm	MAN M/3	LQ401003	999,99
DESERT DRY SUIT HD	4 mm	MAN L/4	LQ401004	999,99
DESERT DRY SUIT HD	4 mm	MAN XL/5	LQ401005	999,99
DESERT DRY SUIT HD	4 mm	MAN 2L/6	LQ401006	999,99
DESERT DRY SUIT HD	4 mm	MAN 3XL/7	LQ401007	999,99
DESERT DRY SUIT HD	4 mm	LADY XS/1	LQ401101	999,99
DESERT DRY SUIT HD	4 mm	LADY S/2	LQ401102	999,99
DESERT DRY SUIT HD	4 mm	LADY M/3	LQ401103	999,99
DESERT DRY SUIT HD	4 mm	LADY L/4	LQ401104	999,99
DESERT DRY SUIT HD	4 mm	LADY XL/5	LQ401105	999,99
INFLATION HOSE + OR FOR DRY SUIT (86cm)			LZ750038	41,99

DRYSUIT UNDERSUIT

RECYCLED MATERIALS

BASE LAYER NEW FLEECE FABRIC

THERMAL UNDERSUIT

The Undersuit is an undersuit to wear underneath your scuba diving drysuit for more warmth. It is lightweight with a front vertical zipper, plus elastic feet and hand stirrups for a more convenient

experience. It is composed of recycled polyester and recycled spandex.

TECHNICAL FEATURES

- Suit for diving
- Recycled polyester + recycled spandex
- Thumb-hole design
- 550g/yd



PRODUCT	SIZE	CODE		RRP €
UNDERSUIT for DRY SUIT	UNISEX XS/1	LW475011		149,99
UNDERSUIT for DRY SUIT	UNISEX S/2	LW475012		149,99
UNDERSUIT for DRY SUIT	UNISEX M/3	LW475013		149,99
UNDERSUIT for DRY SUIT	UNISEX L/4	LW475014		149,99
UNDERSUIT for DRY SUIT	UNISEX XL/5	LW475015		149,99
UNDERSUIT for DRY SUIT	UNISEX 2XL/6	LW475016		149,99
UNDERSUIT for DRY SUIT	UNISEX 3XL/7	LW475017		149,99

ICE  **SPECIALIZED**
Retailer-Product

THICKNESS
7 MM

DRY BACK
ZIP

100% HIGH
STRETCH CONCEPT

ELASTIC
PLUSH INSIDE

10-18° C
50-64.4° F
CE CERTIFICATION
DIVING WETSUIT
EN 14225-1:2017: B



SEMI-DRYSUIT 7 mm

One-piece 7 mm semi-dry suit for cold water. Very easy to wear thanks to special outer ELASTIC SPAN cover and internal ELASTIC PLUSH lining. To facilitate the diver who carries important accessories, the suit is equipped with a convenient double compartment side pocket. One of them has a zipper closure while the other, intended for objects needing faster retrieved, has a Velcro

closing. Two D-RINGS allow you to secure objects. It has a HOOD HOLDER for attaching the hood and special SMALL DYMOND anti-abrasion reinforcements on the shoulders, knees and on the back side. Double cuffs on wrists and ankles. Comfortable waterproof MASTER SEAL rear zip.

TECHNICAL FEATURES

- 7 mm-thick neoprene
- Elastic-span
- Elastic plush inside
- High volume pocket d-ring and hood holder
- Ankles and wrists with double cuffs

Thickness composition



HORIZONTAL DRY BACK TIZIP® MASTERSEAL



HIGH VOLUME POCKET D-RING AND HOOD HOLDER



PRODUCT	THK	SIZE	CODE	RRP €
ICE SEMI-DRY WETSUIT	7 mm	MAN S/2	LQ403402	599,99
ICE SEMI-DRY WETSUIT	7 mm	MAN M/3	LQ403403	599,99
ICE SEMI-DRY WETSUIT	7 mm	MAN L/4	LQ403404	599,99
ICE SEMI-DRY WETSUIT	7 mm	MAN XL/5	LQ403405	599,99
ICE SEMI-DRY WETSUIT	7 mm	MAN 2XL/6	LQ403406	599,99
ICE SEMI-DRY WETSUIT	7 mm	MAN 3XL/7	LQ403407	599,99
ICE SEMI-DRY WETSUIT	7 mm	LADY XS/1	LQ403501	599,99
ICE SEMI-DRY WETSUIT	7 mm	LADY S/2	LQ403502	599,99
ICE SEMI-DRY WETSUIT	7 mm	LADY M/3	LQ403503	599,99
ICE SEMI-DRY WETSUIT	7 mm	LADY L/4	LQ403504	599,99
ICE SEMI-DRY WETSUIT	7 mm	LADY XL/5	LQ403505	599,99



HOOD INCLUDED

FACILE 8MM SPECIALIZED

Retailer-Product

NEW SIZE 2025

MULTI THICKNESS
8+6+5 MM

FRONT
ZIP

ELASTIC SPAN
OUTSIDE

X-PLUSH
INSIDE

 7-12° C
44,6-53,6° F
CE CERTIFICATION
DIVING WETSUIT
EN 14225-1:2017: A

MULTI THICKNESS WETSUIT 8+6+5 mm

One-piece wetsuit with different thicknesses (8, 6.5 e 5 mm) and attached hood for cold water. The suit is characterized by the WATER STOP SYSTEM, whereby a particular bib inside in ULTRASTRETCH material creates a double barrier against water infiltration and improves thermal insulation.

Transverse front zipper, along with the special ELASTIC SPAN cover and X-PLUSH lining, greatly facilitate the fit and donning. Special 6.5 mm inserts on the arms and legs improve the joint anatomy, enabling smoother motion. Additional pre-bent embossing in the folds of the joints.

SMALL DIAMOND anti abrasion reinforcements on the shoulder and back side (buttocks). Protective reinforcement on the knees. 5 mm hood with Air Free valve to remove the air. Wrists and ankles have double cuffs with a zip; the size is printed in evidence on the inside wrists.



HOOD WITH AIR FREE VALVE SYSTEM



ELASTIC-SPAN X-PLUSH INSIDE

ANKLES AND WRISTS WITH DOUBLE CUFFS

TECHNICAL FEATURES

- Multi thickness wetsuit
- Front zip
- Elastic span outside, x-plush inside
- Ankles and wrists with double cuffs

Thickness composition



WATER STOP SYSTEM

HOOD, AIR FREE VALVE

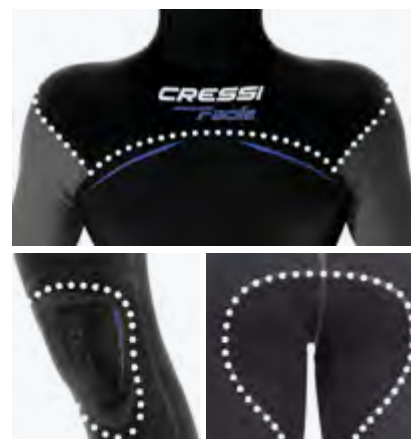

REINFORCED NEOPRENE

PRODUCT	THK	SIZE	CODE	RRP €
FACILE MONOPIECE WETSUIT	8 mm	LADY XS/1	LT473501	429,99
FACILE MONOPIECE WETSUIT	8 mm	LADY S/2	LT473502	429,99
FACILE MONOPIECE WETSUIT	8 mm	LADY M/3	LT473503	429,99
FACILE MONOPIECE WETSUIT	8 mm	LADY L/4	LT473504	429,99
FACILE MONOPIECE WETSUIT	8 mm	LADY XL/5	LT473505	429,99
FACILE MONOPIECE WETSUIT	8 mm	MAN S/2	LT473402	429,99
FACILE MONOPIECE WETSUIT	8 mm	MAN M/3	LT473403	429,99
FACILE MONOPIECE WETSUIT	8 mm	MAN L/4	LT473404	429,99
FACILE MONOPIECE WETSUIT	8 mm	MAN XL/5	LT473405	429,99
FACILE MONOPIECE WETSUIT	8 mm	MAN 2XL/6	LT473406	429,99
FACILE MONOPIECE WETSUIT	8 mm	MAN 3XL/7	LT473407	429,99

NEW

FACILE 5MM



SPECIALIZED
Retailer-Product

NEW 2025

FRONT ZIP

ELASTIC SPAN OUTSIDE

X-PLUSH INSIDE

THICKNESS 5 MM

16-24° C
60.8-75.2° F
CE CERTIFICATION
DIVING WETSUIT
EN 14225-1:2017: C



MULTILAYER 5MM DIVESUIT WITH INTEGRATED WATER STOP SYSTEM

One-piece wetsuit with different thicknesses (5 and 3 mm) and attached hood. The wetsuit features the WATER STOP SYSTEM, whereby a special inner bib with a 3 mm ULTRA STRETCH material zip creates a double barrier against water infiltration and improves thermal insulation.

The transverse front zip and the Ultrastretch materials at the points of articulation considerably

facilitate fit and wearability. The inner lining is made of elastic Plush material to increase the wetsuit's thermal insulation and wearability. Greatly facilitated fit and donning; additional embossing in the joint folds to improve articulation. SMALL DIAMOND abrasion-resistant reinforcements on the shoulders, back, knees and back (buttocks). The knees and elbows also have

additional elastic abrasion-resistant polyurethane protection. 5 mm hood with Air valve to eliminate air. Wrists and ankles have 3 mm cuffs made of a smooth material (Hydro Sealing); the size is prominently printed on the inside of the front under the zip, where there is a white rectangle where the diver's data can be written.

TECHNICAL FEATURES

- 5mm thickness wetsuit
- Front zip
- Elastic span outside, x-plush inside
- Water stop system



WATER STOP SYSTEM

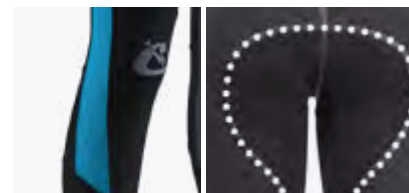

REINFORCED NEOPRENE

PRODUCT	THK	SIZE	CODE		RRP €
FACILE MONOPIECE WETSUIT	5 mm	LADY XS/1	LT472421		349,99
FACILE MONOPIECE WETSUIT	5 mm	LADY S/2	LT472422		349,99
FACILE MONOPIECE WETSUIT	5 mm	LADY M/3	LT472423		349,99
FACILE MONOPIECE WETSUIT	5 mm	LADY L/4	LT472424		349,99
FACILE MONOPIECE WETSUIT	5 mm	LADY XL/5	LT472425		349,99
FACILE MONOPIECE WETSUIT	5 mm	MAN S/2	LT472212		349,99
FACILE MONOPIECE WETSUIT	5 mm	MAN M/3	LT472213		349,99
FACILE MONOPIECE WETSUIT	5 mm	MAN L/4	LT472214		349,99
FACILE MONOPIECE WETSUIT	5 mm	MAN XL/5	LT472215		349,99
FACILE MONOPIECE WETSUIT	5 mm	MAN 2XL/6	LT472216		349,99

COMFORT ATELIER

offline product

THICKNESS
7 MM

BACK
ZIP

100%
ELASTIC SPAN

ELASTIC
PLUSH INSIDE

10-18° C
50-64.4° F
CE CERTIFICATION
DIVING WETSUIT
EN 14225-1:2017: B



100% HIGH-STRETCH MONOPIECE WETSUIT 7 mm

One piece cold water wetsuit made of 7 mm neoprene, with an outer layer in Elastic-Span and inner lining in Elastic-Plush. These materials make the suit warm and extremely elastic, making it very easy to put on. A YKK zipper (ensuring optimal quality) runs vertically on the back. The knees

are reinforced with special protective patches. A very handy pocket on the right leg has two compartments and a useful D-ring. Double sleeves and zippers on wrists and ankles. A special sealing system on the collar minimises water infiltration.

TECHNICAL FEATURES

- 7 mm-thick neoprene
- Elastic-span
- Elastic plush inside
- High volume pocket d-ring and hood holder
- Ankles and wrists with zips and double cuffs
- Anti-seepage collar

Thickness composition

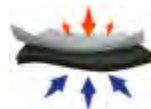

ELASTIC-SPAN
ELASTIC PLUSH INSIDE



HIGH VOLUME
POCKET D-RING
AND HOOD HOLDER

ANKLES AND WRISTS
WITH ZIPS
AND DOUBLE CUFFS



PRODUCT	THK	SIZE	CODE		RRP €
COMFORT MONOPIECE WETSUIT	7 mm	MAN S/2	LS507602		399.99
COMFORT MONOPIECE WETSUIT	7 mm	MAN M/3	LS507603		399.99
COMFORT MONOPIECE WETSUIT	7 mm	MAN L/4	LS507604		399.99
COMFORT MONOPIECE WETSUIT	7 mm	MAN XL/5	LS507605		399.99
COMFORT MONOPIECE WETSUIT	7 mm	MAN 2XL/6	LS507606		399.99
COMFORT MONOPIECE WETSUIT	7 mm	MAN 3XL/7	LS507607		399.99
COMFORT MONOPIECE WETSUIT	7 mm	LADY XS/1	LS507701		399.99
COMFORT MONOPIECE WETSUIT	7 mm	LADY S/2	LS507702		399.99
COMFORT MONOPIECE WETSUIT	7 mm	LADY M/3	LS507703		399.99
COMFORT MONOPIECE WETSUIT	7 mm	LADY L/4	LS507704		399.99
COMFORT MONOPIECE WETSUIT	7 mm	LADY XL/5	LS507705		399.99

COMFORT

THICKNESS
5 MM

BACK
ZIP

100%
ELASTIC SPAN

ELASTIC
PLUSH INSIDE

16-24° C
60.8-75.2° F
CE CERTIFICATION
DIVING WETSUIT
EN 14225-1:2017: C



100% HIGH-STRETCH MONOPIECE WETSUIT 5 mm

One piece wet suit for temperate waters. Made of 5mm-thick neoprene with Elastic-Span external lining and Elastic-Plush internal lining. These materials enhance elasticity, heat level and wearability.

The zip is a YKK in order to guarantee maximum quality and is placed vertically on the rear-side of the suit. The suit includes heavy duty kneepads for extra protection.



TECHNICAL FEATURES

- 5 mm-thick neoprene
- Elastic-span
- Elastic plush inside
- Hood holder

Thickness composition



PRODUCT	THK	SIZE	CODE		RRP €
COMFORT MONOPIECE WETSUIT BLACK	5 mm	MAN S/2	LS507402		349.99
COMFORT MONOPIECE WETSUIT BLACK	5 mm	MAN M/3	LS507403		349.99
COMFORT MONOPIECE WETSUIT BLACK	5 mm	MAN L/4	LS507404		349.99
COMFORT MONOPIECE WETSUIT BLACK	5 mm	MAN XL/5	LS507405		349.99
COMFORT MONOPIECE WETSUIT BLACK	5 mm	MAN 2XL/6	LS507406		349.99
COMFORT MONOPIECE WETSUIT BLACK	5 mm	MAN 3XL/7	LS507407		349.99
COMFORT MONOPIECE WETSUIT BLACK	5 mm	LADY XS/1	LS507501		349.99
COMFORT MONOPIECE WETSUIT BLACK	5 mm	LADY S/2	LS507502		349.99
COMFORT MONOPIECE WETSUIT BLACK	5 mm	LADY M/3	LS507503		349.99
COMFORT MONOPIECE WETSUIT BLACK	5 mm	LADY L/4	LS507504		349.99
COMFORT MONOPIECE WETSUIT BLACK	5 mm	LADY XL/5	LS507505		349.99

FAST  **SPECIALIZED**
Retailer-Product

MONOPIECE WETSUIT 7 mm

Stylish, warm and versatile, the Fast can be used in the widest range of temperate and cold waters. Durable 7 mm, double-lined neoprene, stands up

well to compression at depth for maximum heat retention. Pre-shaped legs improve flexibility for easier kicking.

THICKNESS
7 MM

BACK
ZIP

10-18° C
50-64.4° F
CE CERTIFICATION
DIVING WETSUIT
EN 14225-1:2017: B



TECHNICAL FEATURES

- One-piece 7 mm wetsuit in double lined neoprene
- Ultraspan neoprene on arms and calves
- Pre-shaped legs
- YKK back zip with under zip lining and water-stop system
- Anti-abrasion reinforcement on the knees
- Wrists and ankles with water-stop system / watertight seals



WATERTIGHT SEALS



UNDER ZIP LINING



NEW DESIGN KNEEPAD

PRODUCT	THK	SIZE	CODE	RRP €
FAST MONOPIECE WETSUIT	7 mm	MAN S/2	LR108702	274.99
FAST MONOPIECE WETSUIT	7 mm	MAN M/3	LR108703	274.99
FAST MONOPIECE WETSUIT	7 mm	MAN L/4	LR108704	274.99
FAST MONOPIECE WETSUIT	7 mm	MAN XL/5	LR108705	274.99
FAST MONOPIECE WETSUIT	7 mm	MAN 2XL/6	LR108706	274.99
FAST MONOPIECE WETSUIT	7 mm	MAN 3XL/7	LR108707	274.99
FAST MONOPIECE WETSUIT	7 mm	LADY XS/1	LR109701	274.99
FAST MONOPIECE WETSUIT	7 mm	LADY S/2	LR109702	274.99
FAST MONOPIECE WETSUIT	7 mm	LADY M/3	LR109703	274.99
FAST MONOPIECE WETSUIT	7 mm	LADY L/4	LR109704	274.99
FAST MONOPIECE WETSUIT	7 mm	LADY XL/5	LR109705	274.99



FAST  **SPECIALIZED**
Retailer-Product

THICKNESS 5 MM | BACK ZIP  16-24° C
60.8-75.2° F
CE CERTIFICATION
DIVING WETSUIT
EN 14225-1:2017: C

MONOPIECE WETSUIT 5 mm

Stylish, warm and versatile, the Fast can be used in the widest range of temperate waters. Durable 5 mm, double-lined neoprene, stands up well to

compression at depth for maximum heat retention. Pre-shaped legs improve flexibility for easier kicking.

TECHNICAL FEATURES

- One-piece wetsuit in 5 mm double lined neoprene
- Pre-shaped legs
- YKK back zip with under zip lining and water-stop system
- Anti-abrasion reinforcement on the knees
- Wrists and ankles with water-stop system / watertight seals



WATERTIGHT SEALS



UNDER ZIP LINING



NEW DESIGN KNEEPAD

PRODUCT	THK	SIZE	CODE	RRP €
FAST MONOPIECE WETSUIT	5 mm	MAN S/2	LR108502	219.99
FAST MONOPIECE WETSUIT	5 mm	MAN M/3	LR108503	219.99
FAST MONOPIECE WETSUIT	5 mm	MAN L/4	LR108504	219.99
FAST MONOPIECE WETSUIT	5 mm	MAN XL/5	LR108505	219.99
FAST MONOPIECE WETSUIT	5 mm	MAN 2XL/6	LR108506	219.99
FAST MONOPIECE WETSUIT	5 mm	MAN 3XL/7	LR108507	219.99
FAST MONOPIECE WETSUIT	5 mm	LADY XS/1	LR109501	219.99
FAST MONOPIECE WETSUIT	5 mm	LADY S/2	LR109502	219.99
FAST MONOPIECE WETSUIT	5 mm	LADY M/3	LR109503	219.99
FAST MONOPIECE WETSUIT	5 mm	LADY L/4	LR109504	219.99
FAST MONOPIECE WETSUIT	5 mm	LADY XL/5	LR109505	219.99



FAST  **SPECIALIZED**
Retailer-Product

THICKNESS
3 MM

BACK
ZIP

>22° C
>71.6° F
CE CERTIFICATION
SURFACE WETSUIT
EN 14225-1:2017: D



MONOPIECE WETSUIT 3 mm

Stylish and versatile, the Fast can be used in the widest range of temperate waters. Durable 3 mm neoprene, pre-shaped legs improve flexibility for

easier kicking and anti-abrasion reinforcement on the knees.

TECHNICAL FEATURES

- One-piece wetsuit in 3 mm double lined neoprene
- Pre-shaped legs
- YKK back zip with under zip lining
- Anti-abrasion reinforcement on the knees



PRODUCT	THK	SIZE	CODE		RRP €
FAST MONOPIECE WETSUIT	3 mm	MAN S/2	LR108302		164.99
FAST MONOPIECE WETSUIT	3 mm	MAN M/3	LR108303		164.99
FAST MONOPIECE WETSUIT	3 mm	MAN L/4	LR108304		164.99
FAST MONOPIECE WETSUIT	3 mm	MAN XL/5	LR108305		164.99
FAST MONOPIECE WETSUIT	3 mm	MAN 2XL/6	LR108306		164.99
FAST MONOPIECE WETSUIT	3 mm	MAN 3XL/7	LR108307		164.99
FAST MONOPIECE WETSUIT	3 mm	LADY XS/1	LR109301		164.99
FAST MONOPIECE WETSUIT	3 mm	LADY S/2	LR109302		164.99
FAST MONOPIECE WETSUIT	3 mm	LADY M/3	LR109303		164.99
FAST MONOPIECE WETSUIT	3 mm	LADY L/4	LR109304		164.99
FAST MONOPIECE WETSUIT	3 mm	LADY XL/5	LR109305		164.99

FISTERRA SPECIALIZED

Retailer-Product

AVAILABLE IN TWO THICKNESS: 8 OR 5 MM

TWO-PIECE WETSUIT

ULTRA DURABLE NEOPRENE

 7-12° C
44.6-53.6° F
CE CERTIFICATION DIVING WETSUIT EN 14225-1:2017: A

8 mm

 16-24° C
60.8-75.2° F
CE CERTIFICATION DIVING WETSUIT EN 14225-1:2017: C

5 mm



TWO-PIECE WETSUIT 8 mm, 5 mm

ROBUST WETSUIT ALSO IDEAL FOR COMMERCIAL FISHING

Fisterra was originally born in version 8mm, to respond to the need of professional divers in cold waters. The demand for professional divers, diving instructors and users who demand maximum thermal performance and comfort has encouraged us to incorporate a 5 mm version for temperate waters into the collection.

Fisterra 5 mm is a resistant, very watertight and highly thermal combination with jacket without zippers and high trousers with dungarees. A combination that combines, therefore,

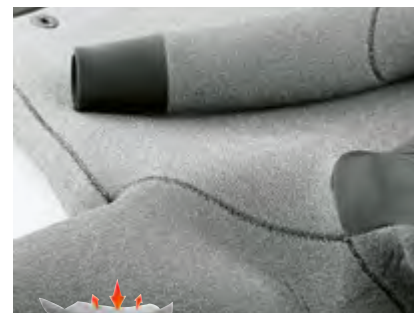
characteristics that place it at the apex of pure performance in a wetsuit of this thickness. Low-compression LC neoprene that guarantees optimum thermal protection at the bottom due to its high resistance to compression ideal for professional work or long duration diving. Nylon outer lining of high weight very resistant, interior X-Plush elastic terry loop, waterproof and great sliding that facilitates the placement and removal of the suit at the same time has a large thermal memory. Wide anti-abrasion knee-spin pads and elbow pads in Supratex®.



ELASTIC PLUSH INSIDE

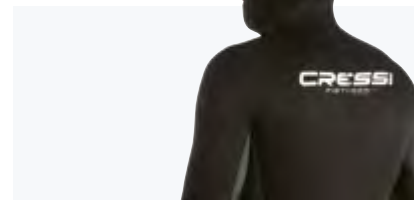

PRODUCT	THK	SIZE	CODE	RRP €
FISTERRA TWO-PIECE WETSUIT	8 mm	S/2	LK489502	349,99
FISTERRA TWO-PIECE WETSUIT	8 mm	M/3	LK489503	349,99
FISTERRA TWO-PIECE WETSUIT	8 mm	L/4	LK489504	349,99
FISTERRA TWO-PIECE WETSUIT	8 mm	XL/5	LK489505	349,99
FISTERRA TWO-PIECE WETSUIT	8 mm	2XL/6	LK489506	349,99
FISTERRA TWO-PIECE WETSUIT	5 mm	S/2	LK489002	299,99
FISTERRA TWO-PIECE WETSUIT	5 mm	M/3	LK489003	299,99
FISTERRA TWO-PIECE WETSUIT	5 mm	L/4	LK489004	299,99
FISTERRA TWO-PIECE WETSUIT	5 mm	XL/5	LK489005	299,99
FISTERRA TWO-PIECE WETSUIT	5 mm	2XL/6	LK489006	299,99

MEDAS

TWO-PIECE WETSUIT 5 mm

The Medas is a classic 5+5 mm suit apt for dives in temperate waters, and also useful in cold waters with use of an inner vest. Renovated pattern, with larger more anatomical panels, in a discrete and elegant combination of black and blue for the male version and black and turquoise for the female version, with contrasting seams and the new logos sporting a more modern look. The pattern of this model is derived from the

most sophisticated Cressi dive models and thus is very anatomical, with preformed legs and arms for an always-natural position and without any seams in the armpit area.

The purchase price is contained, the pattern, the production, and the attention to details make it a great choice and it is one of the most widely used globally.

THICKNESS
5 MM

FRONT
ZIP

TWO-PIECE
WETSUIT

16-24° C
60.8-75.2° F
CE CERTIFICATION
DIVING WETSUIT
EN 14225-1:2017: C



TECHNICAL FEATURES

- Wrists and ankles with "Glide Skin" smooth neoprene micro cuff seals
- Powertex® knee-shin pads
- RIRI® 8 pitch diagonal frontal zipper with metallic pull to prevent tearing
- The facial contouring and neck area have a smooth neoprene insert to minimize leaks.
- Pants with a high closed bib and zipper for greater insulation
- Clip closure in male version and swimsuit style in female version



PRODUCT	THK	SIZE	CODE	RRP €
MEDAS TWO-PIECE WETSUIT	5 mm	MAN S/2	LK486502	299,99
MEDAS TWO-PIECE WETSUIT	5 mm	MAN M/3	LK486503	299,99
MEDAS TWO-PIECE WETSUIT	5 mm	MAN L/4	LK486504	299,99
MEDAS TWO-PIECE WETSUIT	5 mm	MAN XL/5	LK486505	299,99
MEDAS TWO-PIECE WETSUIT	5 mm	MAN 2XL/6	LK486506	299,99
MEDAS TWO-PIECE WETSUIT	5 mm	LADY XS/1	LK486401	299,99
MEDAS TWO-PIECE WETSUIT	5 mm	LADY S/2	LK486402	299,99
MEDAS TWO-PIECE WETSUIT	5 mm	LADY M/3	LK486403	299,99
MEDAS TWO-PIECE WETSUIT	5 mm	LADY L/4	LK486404	299,99
MEDAS TWO-PIECE WETSUIT	5 mm	LADY XL/5	LK486405	299,99

DIVER

MONOPIECE WETSUIT 7 mm, 5 mm

AVAILABLE IN TWO THICKNESS: 7 OR 5 MM

FRONT ZIP

JUNIOR SIZES AVAILABLE

10-18° C
50-64.4° F
CE CERTIFICATION
DIVING WETSUIT
EN 14225-1:2017: B

7 mm
CE

16-24° C
60.8-75.2° F
CE CERTIFICATION
DIVING WETSUIT
EN 14225-1:2017: C

5 mm
CE

All-in-one suit available in 5 and 7 mm double lined neoprene, with incorporated hood and front zip fastening which has recently been up dated, both technically and aesthetically. Traditional all-in-one suit for dives in warm waters, very easy to put on and take off, designed to offer great freedom of movement. The legs are pre-shaped to allow the natural, typical bending of the limbs when swimming. The front zip stretches from the waist to the right cheek.

A smooth neoprene seal runs along the edge of the facial profile of the hood thus limiting water infiltration and increasing comfort. There are reinforced anti-wear pads on the knees. At the wrists the seal is guaranteed by double lined cuffs, the same solution is also used at the ankles, in this case, however, they have handy zips to help the user put on and take off the suit. Available in men's, women's and children's versions.

WHO IT IS FOR

Diver is a wetsuit that has been designed for scuba diving in warm waters, like those of the Mediterranean during the summer months, or those of the tropics during the winter seasons. Quick and easy to put on and take off, it offers great freedom of movement and is much appreciated by diving guides and by those who have to perform several dives on the same day.



REINFORCED NEOPRENE



ANKLE ZIPPER



THK	SIZE	CODE	RRP €
5 mm	MAN S/2	LU489502	249,99
5 mm	MAN M/3	LU489503	249,99
5 mm	MAN L/4	LU489504	249,99
5 mm	MAN XL/5	LU489505	249,99
5 mm	MAN 2XL/6	LU489506	249,99
5 mm	MAN 3XL/7	LU489507	249,99
5 mm	LADY XS/1	LU488001	249,99
5 mm	LADY S/2	LU488002	249,99
5 mm	LADY M/3	LU488003	249,99
5 mm	LADY L/4	LU488004	249,99
5 mm	LADY XL/5	LU488005	249,99
5 mm	JR 3X5 (age 8/9)	LU489001	189,99
5 mm	JR 2X5 (age10/11)	LU489002	189,99
5 mm	JR X5 (age12/13)	LU489003	189,99

THK	SIZE	CODE	RRP €
7 mm	MAN S/2	LU489602	299,99
7 mm	MAN M/3	LU489603	299,99
7 mm	MAN L/4	LU489604	299,99
7 mm	MAN XL/5	LU489605	299,99
7 mm	MAN 2XL/6	LU489606	299,99
7 mm	LADY XS/1	LU489701	299,99
7 mm	LADY S/2	LU489702	299,99
7 mm	LADY M/3	LU489703	299,99
7 mm	LADY L/4	LU489704	299,99
7 mm	LADY XL/5	LU489705	299,99

ENDURANCE

MONOPIECE WETSUIT ADULT 3 mm, JUNIOR 5 mm

THICKNESS 3 OR 5MM FRONT ZIP JUNIOR SIZES AVAILABLE

>22° C
>71.6° F
CE CERTIFICATION
SURFACE WETSUIT
EN 14225-1:2017: D
5 mm
3 mm
CE

3 mm one piece double lined neoprene diving suit. Conceived for intensive use in tepid waters. Easy to put on thanks to its YKK zippers: a heavy duty one on the front and two on the ankles. In the areas most exposed to wear on the part of the jacket,

such as the belly and the shoulders, "Xdiamond", a special neoprene ensuring superior resistance to abrasion, is used. Special neoprene also covers the back and the knees, which are subjected to high stresses.

TECHNICAL FEATURES

- Shoulder, waist, back and knee reinforced pads with X-diamond ultraresistant material
- YKK front zip
- Ankle zipper

REPRICED %



3 mm

5 mm

3 mm

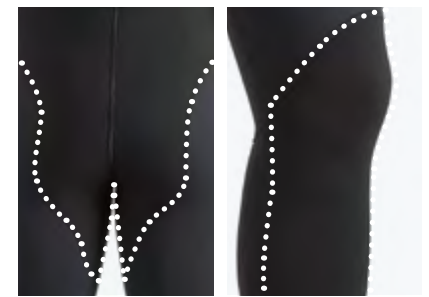
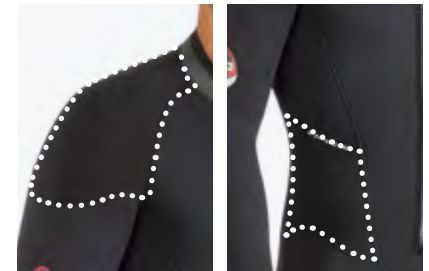

PRODUCT	THK	SIZE	CODE	RRP €
ENDURANCE MONO. WETSUIT	3 mm	MAN S/2	JLV495302	199.99
ENDURANCE MONO. WETSUIT	3 mm	MAN M/3	JLV495303	199.99
ENDURANCE MONO. WETSUIT	3 mm	MAN L/4	JLV495304	199.99
ENDURANCE MONO. WETSUIT	3 mm	MAN XL/5	JLV495305	199.99
ENDURANCE MONO. WETSUIT	3 mm	MAN 2XL/6	JLV495306	199.99
ENDURANCE MONO. WETSUIT	3 mm	LADY XS/1	JLV497301	199.99
ENDURANCE MONO. WETSUIT	3 mm	LADY S/2	JLV497302	199.99
ENDURANCE MONO. WETSUIT	3 mm	LADY M/3	JLV497303	199.99
ENDURANCE MONO. WETSUIT	3 mm	LADY L/4	JLV497304	199.99
ENDURANCE KID MONO.	5 mm	XS (age 8-10)	JLV498301	199.99
ENDURANCE KID MONO.	5 mm	S (age 10-12)	JLV498302	199.99
ENDURANCE KID MONO.	5 mm	M (age 12-14)	JLV498303	199.99
ENDURANCE KID MONO.	5 mm	L (age 14-16)	JLV498304	199.99

SHELL JACKET

OVERSUIT 5+3.5 mm

OVERSUIT WEAR MULTI THICKNESS 5+3.5 MM

The short-sleeved Cressi shell oversuit is made with Ultra Stretch neoprene with differentiated thicknesses. The smooth neoprene facial contour helps to limit the water in-leakage. The shoulder neck is reinforced with a special anti-abrasion X-Diamond material.

Ideal to wear over the wetsuit.

Back and chest: 5 mm
Underarms and inseam: 3.5 mm



PRODUCT	THK	SIZE	CODE	RRP €
SHELL JACKET	5 mm	MAN S/2	LS562002	159,99
SHELL JACKET	5 mm	MAN M/3	LS562003	159,99
SHELL JACKET	5 mm	MAN L/4	LS562004	159,99
SHELL JACKET	5 mm	MAN XL/5	LS562005	159,99
SHELL JACKET	5 mm	MAN 2XL/6	LS562006	159,99
SHELL JACKET	5 mm	MAN 3XL/7	LS562007	159,99
SHELL JACKET	5 mm	LADY XS/1	LS563001	159,99
SHELL JACKET	5 mm	LADY S/2	LS563002	159,99
SHELL JACKET	5 mm	LADY M/3	LS563003	159,99
SHELL JACKET	5 mm	LADY L/4	LS563004	159,99
SHELL JACKET	5 mm	LADY XL/5	LS563005	159,99



HOOD VEST

BASE LAYER 2.5+5 mm

UNDERSUIT WEAR MULTI THICKNESS 2.5 +5 MM

Multi thickness neoprene vest, designed to be worn under the wetsuit.

Vest: 2.5 mm
Hood: 5 mm



PRODUCT	THK	SIZE	CODE	RRP €
BASE LAYER HOOD VEST	2.5 mm	MAN S/2	LW476212	119,99
BASE LAYER HOOD VEST	2.5 mm	MAN M/3	LW476213	119,99
BASE LAYER HOOD VEST	2.5 mm	MAN L/4	LW476214	119,99
BASE LAYER HOOD VEST	2.5 mm	MAN XL/5	LW476215	119,99
BASE LAYER HOOD VEST	2.5 mm	MAN 2XL/6	LW476216	119,99
BASE LAYER HOOD VEST	2.5 mm	MAN 3XL/7	LW476217	119,99
BASE LAYER HOOD VEST	2.5 mm	LADY XS/1	LW476231	119,99
BASE LAYER HOOD VEST	2.5 mm	LADY S/2	LW476232	119,99
BASE LAYER HOOD VEST	2.5 mm	LADY M/3	LW476233	119,99
BASE LAYER HOOD VEST	2.5 mm	LADY L/4	LW476234	119,99
BASE LAYER HOOD VEST	2.5 mm	LADY XL/5	LW476235	119,99

SHORTS VEST

UNDERSUIT WEAR | THICKNESS 2.5 MM

BASE LAYER 2.5 mm

2.5 mm neoprene shorty undersuit, designed to be worn under the wetsuit.



PRODUCT	THK	SIZE	CODE		RRP €
BASE LAYER SHORTS VEST	2.5 mm	MAN S/2	LW476512		79.99
BASE LAYER SHORTS VEST	2.5 mm	MAN M/3	LW476513		79.99
BASE LAYER SHORTS VEST	2.5 mm	MAN L/4	LW476514		79.99
BASE LAYER SHORTS VEST	2.5 mm	MAN XL/5	LW476515		79.99
BASE LAYER SHORTS VEST	2.5 mm	MAN 2XL/6	LW476516		79.99
BASE LAYER SHORTS VEST	2.5 mm	MAN 3XL/7	LW476517		79.99
BASE LAYER SHORTS VEST	2.5 mm	LADY XS/1	LW476521		79.99
BASE LAYER SHORTS VEST	2.5 mm	LADY S/2	LW476522		79.99
BASE LAYER SHORTS VEST	2.5 mm	LADY M/3	LW476523		79.99
BASE LAYER SHORTS VEST	2.5 mm	LADY L/4	LW476524		79.99
BASE LAYER SHORTS VEST	2.5 mm	LADY XL/5	LW476525		79.99

CORE VEST

UNDERSUIT WEAR | THICKNESS 2.5 MM

BASE LAYER 2.5 mm

2.5 mm neoprene core vest, designed to be worn under the wetsuit.



PRODUCT	THK	SIZE	CODE		RRP €
BASE LAYER CORE VEST	2.5 mm	MAN S/2	LW476102		69.99
BASE LAYER CORE VEST	2.5 mm	MAN M/3	LW476103		69.99
BASE LAYER CORE VEST	2.5 mm	MAN L/4	LW476104		69.99
BASE LAYER CORE VEST	2.5 mm	MAN XL/5	LW476105		69.99
BASE LAYER CORE VEST	2.5 mm	MAN 2XL/6	LW476106		69.99
BASE LAYER CORE VEST	2.5 mm	MAN 3XL/7	LW476107		69.99
BASE LAYER CORE VEST	2.5 mm	LADY XS/1	LW476111		69.99
BASE LAYER CORE VEST	2.5 mm	LADY S/2	LW476112		69.99
BASE LAYER CORE VEST	2.5 mm	LADY M/3	LW476113		69.99
BASE LAYER CORE VEST	2.5 mm	LADY L/4	LW476114		69.99
BASE LAYER CORE VEST	2.5 mm	LADY XL/5	LW476115		69.99

ALTUM

MONOPIECE WETSUIT 3 mm

The Altum one-piece wetsuit is perfect for snorkeling, swimming and water sports enthusiasts. Made of 3 mm neoprene, it offers exceptional comfort and optimal protection. The assembly with flat seams and abrasion-resistant thread ensures superior durability, while the high-

quality back zipper ensures a comfortable and secure fit. The ankles and cuffs are made with an overlak hem, which prevents skin irritation and keeps the wetsuit securely in place. With Altum you can enjoy your water adventures to the fullest.

THICKNESS 3 MM | MONOPIECE WETSUIT | REAR ZIP | OVERLOK HEMMED

TECHNICAL FEATURES

- Perfect for snorkelling, swimming and water sports
- 3 mm neoprene
- Assembly with flat seams and anti-abrasion thread
- High-quality rear zip
- Ankles and wrists are overlak hemmed



PRODUCT	THK	SIZE	CODE		RRP €
MAN MONOPIECE BLACK/BLUE	3mm	S/2	XLV435912		199,99
MAN MONOPIECE BLACK/BLUE	3mm	M/3	XLV435913		199,99
MAN MONOPIECE BLACK/BLUE	3mm	L/4	XLV435914		199,99
MAN MONOPIECE BLACK/BLUE	3mm	XL/5	XLV435915		199,99
MAN MONOPIECE BLACK/BLUE	3mm	2XL/6	XLV435916		199,99
MAN MONOPIECE BLACK/BLUE	3mm	3XL/7	XLV435917		199,99
LADY MONOPIECE BLACK/PINK	3mm	XS/1	XLV435951		199,99
LADY MONOPIECE BLACK/PINK	3mm	S/2	XLV435952		199,99
LADY MONOPIECE BLACK/PINK	3mm	M/3	XLV435953		199,99
LADY MONOPIECE BLACK/PINK	3mm	L/4	XLV435954		199,99
LADY MONOPIECE BLACK/PINK	3mm	XL/5	XLV435955		199,99

MOREA

MONOPIECE WETSUIT 3 mm

The Morea is a 3 mm neoprene one-piece without a hood, sporting long sleeves and pants, perfect for any aquatic sport.

THICKNESS
3 MM

BACK
ZIP

JUNIOR SIZES
AVAILABLE

MIXED ULTRASpan
MATERIAL

>22° C
>71.6° F
CE CERTIFICATION
SURFACE WETSUIT
EN 14225-1:2017: D



PREMIUM
ULTRA STRETCH
NEOPRENE
ON ARMS



PREMIUM
ULTRA STRETCH
NEOPRENE
ON LEGS

TECHNICAL FEATURES

- 3-mm neoprene with Ultraspan ends on the arms and legs.
- Rubberized neoprene on the chest and protection on the knees.



PRODUCT	THK	SIZE	CODE		RRP €
MOREA MONOPIECE BLACK/BLUE	3 mm	MAN S/2	LU476002		179.99
MOREA MONOPIECE BLACK/BLUE	3 mm	MAN M/3	LU476003		179.99
MOREA MONOPIECE BLACK/BLUE	3 mm	MAN L/4	LU476004		179.99
MOREA MONOPIECE BLACK/BLUE	3 mm	MAN XL/5	LU476005		179.99
MOREA MONOPIECE BLACK/BLUE	3 mm	MAN 2XL/6	LU476006		179.99
MOREA MONOPIECE BLACK/TURQUOISE	3 mm	LADY XS/1	LU476501		179.99
MOREA MONOPIECE BLACK/TURQUOISE	3 mm	LADY S/2	LU476502		179.99
MOREA MONOPIECE BLACK/TURQUOISE	3 mm	LADY M/3	LU476503		179.99
MOREA MONOPIECE BLACK/TURQUOISE	3 mm	LADY L/4	LU476504		179.99
MOREA MONOPIECE BLACK/TURQUOISE	3 mm	LADY XL/5	LU476505		179.99
MOREA MONOPIECE JR	3 mm	JR 3/4Y	LU476611		159.99
MOREA MONOPIECE JR	3 mm	JR 5/6Y	LU476612		159.99
MOREA MONOPIECE JR	3 mm	JR 6/7Y	LU476601		159.99
MOREA MONOPIECE JR	3 mm	JR 8/9Y	LU476602		159.99
MOREA MONOPIECE JR	3 mm	JR 10/11Y	LU476603		159.99
MOREA MONOPIECE JR	3 mm	JR 12/13Y	LU476604		159.99
MOREA MONOPIECE JR	3 mm	JR 13/14Y	LU476605		159.99

LUI, LEI

MONOPIECE WETSUIT 2.5 mm

This a front-entry fullsuit is effortless to don and provides just the right warmth (and uv protection) for diving, snorkeling and other water sports in warm water. Cuff seals help prevent water entry while swimming and the double lined neoprene resists compression at depth. The wetsuit features a separate anatomical cuts for both men and women. It is made in double lined

neoprene thick 2.5 mm thick. The double-lined is stronger than single-lined of other competitors wetsuit. It is very easy to wear thanks to th front zip. The aquastop wrist and ankle seals limit the water exchange. Ideal for any kind of water sport, windsurfing, kitesurfing, snorkeling, diving, surfing.

THICKNESS
2.5 MM

FRONT
ZIP

>22° C
>71.6° F
CE CERTIFICATION
SURFACE WETSUIT
EN 14225-1:2017: D



TECHNICAL FEATURES

- Separate anatomical cuts for both men and women
- Front zip entry for easier donning
- YKK zipper and Aquastop under zip lining
- Aquastop wrist and ankle seals limit water exchange
- Pre-shaped legs improve flexibility for easy kicking

REPRICED %



COLOR	THK	SIZE	CODE		RRP €
BLACK/YELLOW	2.5 mm	MAN 5/2	LU479002		149,99
BLACK/YELLOW	2.5 mm	MAN M/3	LU479003		149,99
BLACK/YELLOW	2.5 mm	MAN L/4	LU479004		149,99
BLACK/YELLOW	2.5 mm	MAN XL/5	LU479005		149,99
BLACK/YELLOW	2.5 mm	MAN 2XL/6	LU479006		149,99
BLACK/PINK	2.5 mm	LADY XS/1	LU478001		149,99
BLACK/PINK	2.5 mm	LADY 5/2	LU478002		149,99
BLACK/PINK	2.5 mm	LADY M/3	LU478003		149,99
BLACK/PINK	2.5 mm	LADY L/4	LU478004		149,99
BLACK/PINK	2.5 mm	LADY XL/5	LU478005		149,99

WAHOO

ADULT LONG SLEEVES WETSUIT 2mm

One-piece wetsuit for adult, made from 1.5/2 mm thick neoprene (front and back) and from Elastane (sides, sleeves and collar). YKK front zip.

Offers excellent protection from the cold and the sun and maximum freedom of movement thanks to the areas in Elastane that won't irritate the skin whilst water activities.

EXCELLENT FIT

COMPOSITION
NEOPRENE 85% - ELASTANE 15%

SUN, WIND AND COLD
PROTECTION

TECHNICAL FEATURES

- Premium 1.5/2mm neoprene
- For snorkeling, swimming, and water sports
- Protection from the sun, wind, and cold
- Front zip



□ NEOPRENE
■ ELASTANE

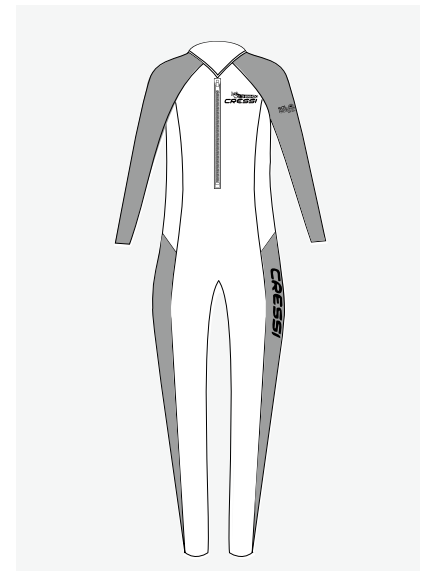

COLOR	THK	SIZE	CODE		RRP €
WAHOO MAN MONOPIECE WETSUIT	2 mm	MAN XS/1	XDG022021		79,99
WAHOO MAN MONOPIECE WETSUIT	2 mm	MAN S/2	XDG022022		79,99
WAHOO MAN MONOPIECE WETSUIT	2 mm	MAN M/3	XDG022023		79,99
WAHOO MAN MONOPIECE WETSUIT	2 mm	MAN L/4	XDG022024		79,99
WAHOO MAN MONOPIECE WETSUIT	2 mm	MAN XL/5	XDG022025		79,99
WAHOO MAN MONOPIECE WETSUIT	2 mm	MAN 2XL/6	XDG022026		79,99
WAHOO MAN MONOPIECE WETSUIT	2 mm	MAN 3XL/7	XDG022027		79,99
WAHOO MAN MONOPIECE WETSUIT	2 mm	LADY XS/1	XDG022121		79,99
WAHOO LADY MONOPIECE WETSUIT	2 mm	LADY S/2	XDG022122		79,99
WAHOO LADY MONOPIECE WETSUIT	2 mm	LADY M/3	XDG022123		79,99
WAHOO LADY MONOPIECE WETSUIT	2 mm	LADY L/4	XDG022124		79,99
WAHOO LADY MONOPIECE WETSUIT	2 mm	LADY XL/5	XDG022125		79,99
WAHOO LADY MONOPIECE WETSUIT	2 mm	LADY 2XL/5	XDG022126		79,99



SKIN

FULLSUIT 1 mm

Crafted from 1 mm material (86% Polyester / 14% Spandex), the Skin is a versatile and a must-have fullsuit for traveling divers. The high-stretch material is effortless to swim in and naturally conforms to the body to reduce drag. The Skin provides UV protection on the surface and just the

warmth needed for extended snorkeling or diving sessions in tropical waters. A long front zip makes the Skin easy to put on and the suit easily layers under thicker dive wear.

THICKNESS 1 MM | FRONT ZIP | 86% POLYESTER 14% SPANDEX

TECHNICAL FEATURES

- High-stretch 1 mm material easy to swim in
- Heel straps providing a secure fit
- Easy to don with front-entry zipper



PRODUCT	THK	SIZE	CODE		RRP €
BLACK/BLUE	1 mm	MAN S/2	WDG050202		79.99
BLACK/BLUE	1 mm	MAN M/3	WDG050203		79.99
BLACK/BLUE	1 mm	MAN L/4	WDG050204		79.99
BLACK/BLUE	1 mm	MAN XL/5	WDG050205		79.99
BLACK/BLUE	1 mm	MAN 2XL/6	WDG050206		79.99
BLACK/PINK	1 mm	LADY XS/1	WDG050401		79.99
BLACK/PINK	1 mm	LADY S/2	WDG050402		79.99
BLACK/PINK	1 mm	LADY M/3	WDG050403		79.99
BLACK/PINK	1 mm	LADY L/4	WDG050404		79.99
BLACK/PINK	1 mm	LADY XL/5	WDG050405		79.99

SHORTY WETSUITS



/ SHORTY WETSUITS



Photo by: Ourdays

ALTUM

SHORTY WETSUIT 3 mm

One-piece shorty in 3 mm double-lined/mono-lined neoprene. Perfect for snorkeling, swimming, sailing and all water sports in general. Lightweight

and easy to wear, it allows excellent freedom of movement. Stylish and versatile, the Altum can be used in the broadest range of temperate waters.

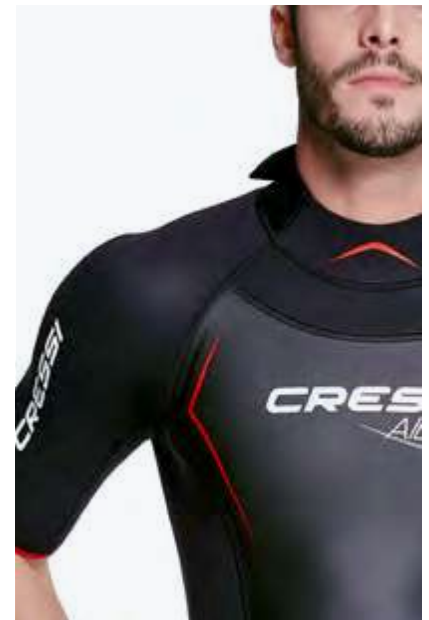

PRODUCT	THK	SIZE	CODE		RRP €
ALTUM SHORTY WETSUIT BLACK/RED	3 mm	MAN S/2	XLV436022		129.99
ALTUM SHORTY WETSUIT BLACK/RED	3 mm	MAN M/3	XLV436023		129.99
ALTUM SHORTY WETSUIT BLACK/RED	3 mm	MAN L/4	XLV436024		129.99
ALTUM SHORTY WETSUIT BLACK/RED	3 mm	MAN XL/5	XLV436025		129.99
ALTUM SHORTY WETSUIT BLACK/RED	3 mm	MAN 2XL/6	XLV436026		129.99
ALTUM SHORTY WETSUIT BLACK/RED	3 mm	MAN 3XL/7	XLV436027		129.99
ALTUM SHORTY WETSUIT BLACK/PINK	3 mm	LADY XS/1	XLV436061		129.99
ALTUM SHORTY WETSUIT BLACK/PINK	3 mm	LADY S/2	XLV436062		129.99
ALTUM SHORTY WETSUIT BLACK/PINK	3 mm	LADY M/3	XLV436063		129.99
ALTUM SHORTY WETSUIT BLACK/PINK	3 mm	LADY L/4	XLV436064		129.99
ALTUM SHORTY WETSUIT BLACK/PINK	3 mm	LADY XL/5	XLV436065		129.99

MED X

NEW SIZES 2025

THICKNESS 2.5 MM | BACK ZIP | JUNIOR SIZES AVAILABLE

SHORTY WETSUIT 2.5 mm

This is the new version of the most known Cressi one-piece wetsuit for water sports and tropical seas. It's presented with a new pattern, and new captivating aesthetic. It's available in man, woman and kids version.

Monoshort without hook, with short pants and sleeves in double fodder neoprene 2.5mm.

Flat neoprene on the chest area to obtain more elasticity.

YKK® 8 pitch dorsal zip with Velcro® closing.

TECHNICAL FEATURES

- Rear zip.
- Adjustable collar with Velcro closure.
- Children's sizes available.



NEW
NEW

NEW
NEW

PRODUCT	THK	SIZE	CODE		RRP €
MED X SHORTY WETSUIT	2.5 mm	MAN XS/1	LV437001		99,99
MED X SHORTY WETSUIT	2.5 mm	MAN S/2	LV437002		99,99
MED X SHORTY WETSUIT	2.5 mm	MAN M/3	LV437003		99,99
MED X SHORTY WETSUIT	2.5 mm	MAN L/4	LV437004		99,99
MED X SHORTY WETSUIT	2.5 mm	MAN XL/5	LV437005		99,99
MED X SHORTY WETSUIT	2.5 mm	MAN 2XL/6	LV437006		99,99
MED X SHORTY WETSUIT	2.5 mm	MAN 3XL/7	LV437007		99,99
MED X SHORTY WETSUIT	2.5 mm	MAN 4XL/8	LV437008		99,99
MED X SHORTY WETSUIT	2.5 mm	LADY XS/1	LV437501		99,99
MED X SHORTY WETSUIT	2.5 mm	LADY S/2	LV437502		99,99
MED X SHORTY WETSUIT	2.5 mm	LADY M/3	LV437503		99,99
MED X SHORTY WETSUIT	2.5 mm	LADY L/4	LV437504		99,99
MED X SHORTY WETSUIT	2.5 mm	LADY XL/5	LV437505		99,99
MED X SHORTY WETSUIT	2.5 mm	LADY 2XL/6	LV437506		99,99
MED X SHORTY WETSUIT	2.5 mm	JR XS/(age 6/7)	LV438001		79,99
MED X SHORTY WETSUIT	2.5 mm	JR S/(age 8/9)	LV438002		79,99
MED X SHORTY WETSUIT	2.5 mm	JR M/(age10/11)	LV438003		79,99
MED X SHORTY WETSUIT	2.5 mm	JRL/(age12/13)	LV438004		79,99
MED X SHORTY WETSUIT	2.5 mm	JR XL/(age 14/15)	LV438005		79,99

/ SHORTY WETSUITS



PLAYA

NEW COLORS 2025

SHORTY WETSUIT 2.5 mm

Hoodless one piece with shorts and short sleeves, in 2.5-mm double-lined neoprene. Plastic YKK® zipper that's impervious to external agents, located on the front to make it easier to put on the suit. Flat stitching with scratch-resistant thread and sleeves and legs hemmed with neoprene for

improved durability and comfort. Playa is perfect for snorkeling, swimming, sailing, and water sports in general.

TECHNICAL FEATURES

- Separate anatomical cuts for both men and women
- Single neoprene cuff seals
- Front zip entry for easier donning



MAN:

LADY:



BLACK/RED



BLACK/PINK



BLACK/LIME



BLACK/AQUAMARINE



SIZE	BLACK/RED	BLACK/LIME	BLACK/PINK	BLACK/ACUQAM.	THK	RRP €
MAN XS/1	LV445001	-	-	-	2.5mm	89,99
MAN S/2	LV445002	XLV445052	-	-	2.5mm	89,99
MAN M/3	LV445003	XLV445053	-	-	2.5mm	89,99
MAN L/4	LV445004	XLV445054	-	-	2.5mm	89,99
MAN XL/5	LV445005	XLV445055	-	-	2.5mm	89,99
MAN 2XL/6	LV445006	XLV445056	-	-	2.5mm	89,99
MAN 3XL/7	-	XLV445057	-	-	2.5mm	89,99
MAN 4XL/6	-	XLV445058	-	-	2.5mm	89,99
LADY XS/1	-	-	LV446001	XLV446021	2.5mm	89,99
LADY S/2	-	-	LV446002	XLV446022	2.5mm	89,99
LADY M/3	-	-	LV446003	XLV446023	2.5mm	89,99
LADY L/4	-	-	LV446004	XLV446024	2.5mm	89,99
LADY XL/5	-	-	LV446005	XLV446025	2.5mm	89,99
LADY 2XL/6	-	-	-	XLV446026	2.5mm	89,99

LIDO

SHORTY WETSUIT 2 mm

Highly flexible 2 mm neoprene and a flattering cut conform easily to most body shapes for a great fit.

THICKNESS
2 MM

FRONT ZIPPER ENTRY
ZIP 2.5 MM AVAILABLE



TECHNICAL FEATURES

- Separate anatomical cuts for both men and women
- Double-lined neoprene
- Front zip entry for easier donning

MAN:

LADY:



BLACK/BLUE



BLACK/AQUAMARINE



BLACK/RED



BLACK/LILAC

PRODUCT	THK	SIZE	CODE		RRP €
LIDO SHORTY BLACK/BLUE	2 mm	MAN XS/1	LV455001		69,99
LIDO SHORTY BLACK/BLUE	2 mm	MAN S/2	LV455002		69,99
LIDO SHORTY BLACK/BLUE	2 mm	MAN M/3	LV455003		69,99
LIDO SHORTY BLACK/BLUE	2 mm	MAN L/4	LV455004		69,99
LIDO SHORTY BLACK/BLUE	2 mm	MAN XL/5	LV455005		69,99
LIDO SHORTY BLACK/BLUE	2 mm	MAN 2XL/6	LV455006		69,99
LIDO SHORTY BLACK/BLUE	2 mm	MAN 3XL/7	LV455007		69,99
LIDO SHORTY BLACK/RED	2 mm	MAN S/2	XLV455512		79,99
LIDO SHORTY BLACK/RED	2 mm	MAN M/3	XLV455513		79,99
LIDO SHORTY BLACK/RED	2 mm	MAN L/4	XLV455514		79,99
LIDO SHORTY BLACK/RED	2 mm	MAN XL/5	XLV455515		79,99
LIDO SHORTY BLACK/RED	2 mm	MAN 2XL/6	XLV455516		79,99
LIDO SHORTY BLACK/RED	2 mm	MAN 3XL/7	XLV455517		79,99
LIDO SHORTY BLACK/AQUAMARINE	2 mm	LADY XS/1	LV457001		79,99
LIDO SHORTY BLACK/AQUAMARINE	2 mm	LADY S/2	LV457002		79,99
LIDO SHORTY BLACK/AQUAMARINE	2 mm	LADY M/3	LV457003		79,99
LIDO SHORTY BLACK/AQUAMARINE	2 mm	LADY L/4	LV457004		79,99
LIDO SHORTY BLACK/AQUAMARINE	2 mm	LADY XL/5	LV457005		79,99
LIDO SHORTY BLACK/LILAC	2 mm	LADY S/2	XLV457502		79,99
LIDO SHORTY BLACK/LILAC	2 mm	LADY M/3	XLV457503		79,99
LIDO SHORTY BLACK/LILAC	2 mm	LADY L/4	XLV457504		79,99
LIDO SHORTY BLACK/LILAC	2 mm	LADY XL/5	XLV457505		79,99
LIDO SHORTY BLACK/LILAC	2 mm	LADY 2XL/6	XLV457506		79,99



TIBURON

EXCELLENT FIT

COMPOSITION
NEOPRENE 85% - ELASTANE 15%

SUN, WIND AND COLD
PROTECTION

ADULT SHORT SLEEVES WETSUIT 2mm

One-piece wetsuit for adult, made from 1.5/2 mm thick neoprene (front and back) and from Elastane (sides, sleeves and collar). YKK front zip.

Offers excellent protection from the cold and the sun and maximum freedom of movement thanks to the areas in Elastane that won't irritate the skin whilst water activities.

TECHNICAL FEATURES

- Premium 1.5/2mm neoprene
- For snorkeling, swimming, and water sports
- Protection from the sun, wind, and cold
- Front zip



□ NEOPRENE
■ ELASTANE

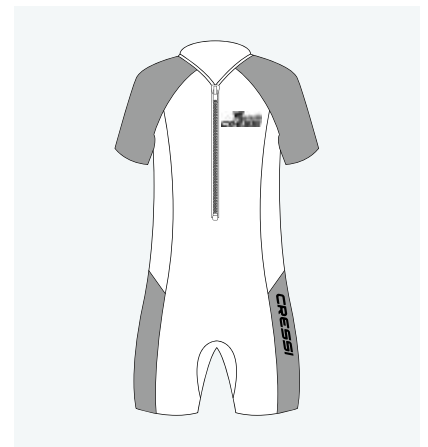

PRODUCT	THK	SIZE	CODE		RRP €
TIBURON MAN SHORTY WETSUIT	2 mm	S/2	XDG014522		49,99
TIBURON MAN SHORTY WETSUIT	2 mm	M/3	XDG014523		49,99
TIBURON MAN SHORTY WETSUIT	2 mm	L/4	XDG014524		49,99
TIBURON MAN SHORTY WETSUIT	2 mm	XL/5	XDG014525		49,99
TIBURON MAN SHORTY WETSUIT	2 mm	2XL/6	XDG014526		49,99
TIBURON LADY SHORTY WETSUIT	2 mm	XS/1	XDG015521		49,99
TIBURON LADY SHORTY WETSUIT	2 mm	S/2	XDG015522		49,99
TIBURON LADY SHORTY WETSUIT	2 mm	M/3	XDG015523		49,99
TIBURON LADY SHORTY WETSUIT	2 mm	L/4	XDG015524		49,99
TIBURON LADY SHORTY WETSUIT	2 mm	XL/5	XDG015525		49,99



CRESSI
KIDS



CRESSI
JUNIOR

COMPOSITION
NEOPRENE 85% - ELASTANE 15%

SUN, WIND AND COLD
PROTECTION

LITTLE SHARK L.S.

JUNIOR LONG SLEEVES WETSUIT 2mm

The longer version of the Little Shark. Cressi Little Shark L.S. offers good protection wet or dry, against sun, wind, and cold. The front zip makes it comfortable and quick to put on and take off, and it reduces water leaks to a minimum. Cressi Little Shark is also effective protection

against jellyfish. In special highly elastic fabric and neoprene, it offers excellent freedom of movement and superior comfort.



BLACK/PINK

BLACK/BLUE

TECHNICAL FEATURES

- Premium 1.5/2mm neoprene
- For snorkeling, swimming, and water sports
- Protection from the sun, wind, and cold
- Front zip

☐ NEOPRENE
☑ ELASTANE



JR AGE	WEIGHT (KG)	HEIGHT (CM)
3-4	13.1 - 20.9	83.2 - 109.2
5-6	20.9 - 25.6	109.2 - 119.4
7-8	25.6 - 32.2	119.4 - 134.6
9-10	32.2 - 38.6	134.6 - 144.8
11-12	38.6 - 43.5	144.8 - 149.9
13-14	43.5 - 47.2	149.9 - 157.5

JR AGE	WEIGHT (LB)	HEIGHT (INCH)
3-4	29 - 46	33 - 43
5-6	46 - 57	43 - 47
7-8	57 - 71	47 - 53
9-10	71 - 85	53 - 57
11-12	85 - 96	57 - 59
13-14	96 - 104	59 - 62

AGE	BLACK/BLUE	BLACK/PINK	RRP €
3-4	XDG006203	XDG006403	44,99
5-6	XDG006204	XDG006404	44,99
7-8	XDG006205	XDG006405	44,99
9-10	XDG006206	XDG006406	44,99
11-12	XDG006207	XDG006407	44,99
13-14	XDG006208	XDG006408	44,99
15-16	XDG006209	XDG006409	44,99

LITTLE SHARK

JUNIOR SHORT SLEEVES WETSUIT 2mm

Cressi Little Shark offers good protection wet or dry, against sun, wind, and cold. The front zip makes it comfortable and quick to put on and take off, and it reduces water leaks to a minimum.

Cressi Little Shark is also effective protection against jellyfish. In special highly elastic fabric and neoprene, it offers excellent freedom of movement and superior comfort.



BLACK/BLUE

BLACK/PINK

BLACK/LIME

BLACK/YELLOW

AGE	BLACK/BLUE	BLACK/PINK	BLACK/LIME	BLACK/YELLOW	RRP €
3-4	DG003503	DG003103	XDG003303	XDG003203	39,99
5-6	DG003504	DG003104	XDG003304	XDG003204	39,99
7-8	DG003505	DG003105	XDG003305	XDG003205	39,99
9-10	DG003506	DG003106	XDG003306	XDG003206	39,99
11-12	DG003507	DG003107	XDG003307	XDG003207	39,99
13-14	DG003508	DG003108	XDG003308	XDG003208	39,99

EXCELLENT FIT

COMPOSITION
NEOPRENE 85% - ELASTANE 15%

SUN, WIND AND COLD
PROTECTION

TECHNICAL FEATURES

- Premium 1.5/2mm neoprene
- For snorkeling, swimming, and water sports
- Protection from the sun, wind, and cold
- Front zip

□ NEOPRENE
■ ELASTANE



JR AGE	WEIGHT (KG)	HEIGHT (CM)
3-4	13.1 - 20.9	83.2 - 109.2
5-6	20.9 - 25.6	109.2 - 119.4
7-8	25.6 - 32.2	119.4 - 134.6
9-10	32.2 - 38.6	134.6 - 144.8
11-12	38.6 - 43.5	144.8 - 149.9
13-14	43.5 - 47.2	149.9 - 157.5

JR AGE	WEIGHT (LB)	HEIGHT (INCH)
3-4	29 - 46	33 - 43
5-6	46 - 57	43 - 47
7-8	57 - 71	47 - 53
9-10	71 - 85	53 - 57
11-12	85 - 96	57 - 59
13-14	96 - 104	59 - 62



CRESSI
BABY



CRESSI
KIDS

KIDS SHORTY

KIDS SHORT SLEEVES WETSUIT 1.5mm

One-piece wetsuit for children, made from 1.5/2 mm thick neoprene (front and back) and from Elastane (sides, sleeves and collar), YKK front zip.

Offers excellent protection from the cold and the sun and maximum freedom of movement thanks to the areas in Elastane that won't irritate the skin whilst swimming.

MAXIMUM FREEDOM OF MOVEMENT

COMPOSITION NEOPRENE: FRONT & BACK

COMPOSITION ELASTANE: SIDES, SLEEVES & COLLAR

SUN AND COLD PROTECTION

TECHNICAL FEATURES

- Premium 1.5/2mm neoprene
- For snorkeling, swimming, and water sports
- Protection from the sun, wind, and cold
- Front zip

□ NEOPRENE
■ ELASTANE



JR AGE	WEIGHT (KG)	HEIGHT (CM)
2	10 - 12	85 - 90
3	12 - 14	90 - 95
4	15 - 20	95 - 105
5-6	20 - 25.6	105 - 119.4
7-8	25.6 - 32.2	119.4 - 134.6

JR AGE	WEIGHT (LB)	HEIGHT (INCH)
2	22 - 26	33.5 - 35.4
3	26 - 30	35.4 - 37.4
4	33 - 44	37.4 - 41
5-6	44 - 56	41 - 47
7-8	56 - 70	47 - 53



BLUE

PINK

BLACK/LIME

AGE	BLUE	PINK	BLACK/LIME	RRP €
2	DG001001	DG001101	XDG001301	44,99
3	DG001002	DG001102	XDG001302	44,99
4	DG001003	DG001103	XDG001303	44,99
5-6	DG001004	DG001104	XDG001304	44,99
7-8	DG001005	DG001105	XDG001305	44,99



EASY ACCESS FOR USE WITH CRESSI SWIM DIAPERS

COMPOSITION NEOPRENE 100%

KEEPS CHILDREN WARM

BABY WARMER

BABY WETSUIT 1.5 mm

This baby warmer has been constructed with neoprene, which guarantees warmth and sun protection.



BLUE

PINK

AGE	BLUE	PINK	RRP €
6-12 months	DG002006	DG002106	29,99
12-18 months	DG002012	DG002112	29,99
18-24 months	DG002018	XDG002118	29,99

TECHNICAL FEATURES

- Kid safe but is not a life saving device. Should always be used under adult supervision.
- With back flotation for survival breathing training
- Provides comfort with and without swimming diapers



MONTHS	WEIGHT (KG)	HEIGHT (CM)
6-12	7 - 13	76
12-18	9 - 17	81
18-24	14+	91

MONTHS	WEIGHT (LB)	HEIGHT (INCH)
6-12	16 - 28	30
12-18	22 - 37	32
18-24	30+	36

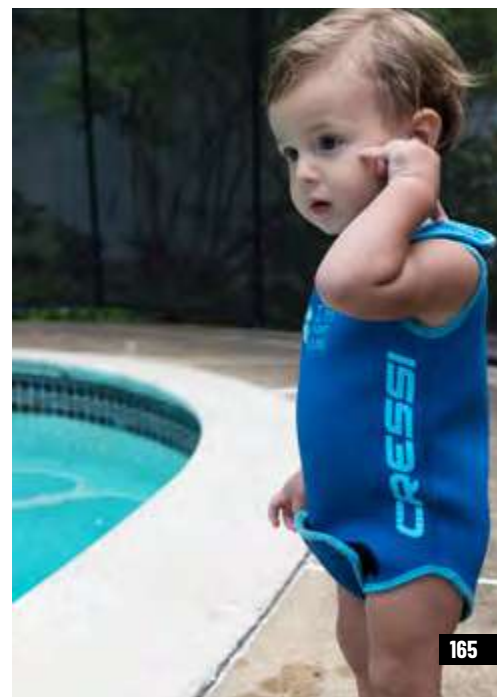

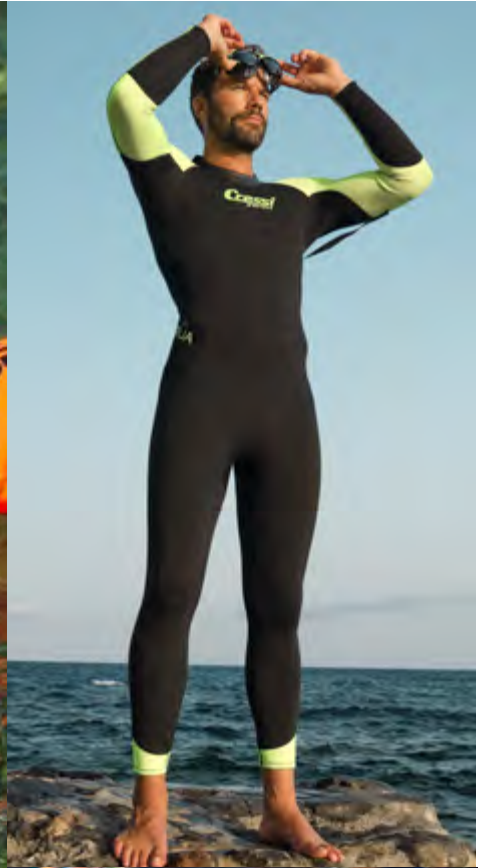

Photo by: Wojciech Dopierala

SWIMMING WETSUITS

KUWAE

MULTI THICKNESS MONOPIECE WETSUIT 4+3+2 mm

The new Cressi swimming suit is inspired by the underwater caldera Kuwae, located in the Vanuatu archipelago in the South Pacific Ocean. The coral colour of the upper part of the wetsuit recalls the lava of the volcanic eruption, like the truly explosive design. This particular colour was also chosen to give the swimmer maximum visibility when in open water. Kuwae has been entirely designed with the help of sophisticated 3D software for the modelling of wetsuits, which made it possible to study the fitting of the materials and the different sizes on virtual mannequins. In this way, Cressi not only

facilitates an innovative approach to research and development, but also obtains a positive environmental impact by eliminating unnecessary sample collections.

The different thicknesses (2-3-4 mm) of the super-elastic materials favour buoyancy, help the swimmer to achieve a perfect trim when swimming on the surface and improve the fit in the arms/ armpits, while ensuring complete freedom of movement.

The striped material insert applied in the wrist area helps to move more water during the classic freestyle stroke. The new low neckline design has

been studied to avoid any friction around the neck, while maintaining a perfect seal against water infiltration.

On the inner part of the under zip panel it is possible to customize the wetsuit with your name and insert the key of any means of transport in the special pocket. The YKK back zip guarantees tightness and resistance over time: the slider is made of anti-corrosion metal material, to ensure greater sturdiness when pulling the lanyard during the closing/opening of the wetsuit.

TECHNICAL FEATURES

- The ultimate swimming wetsuit
- Completely designed with a sophisticated 3d modelling software
- Graphics inspired by underwater volcanic eruption
- Maximum visibility for the swimmer when in open water
- Back zip
- Different thicknesses (2-3-4 mm)



SWIM HOOD INCLUDED WITH EACH PURCHASED WETSUIT



TOP/ARMS 2 mm COMPLETE FREEDOM OF MOVEMENT

FRONT 3 mm COLD WATER PROTECTION

LEGS 4 mm IMPROVED BUOYANCY



NEW LOW NECKLINE DESIGN



PRODUCT	THK	SIZE	CODE		RRP €
KUWAE SWIMSUIT BLACK/RED	2/3/4mm	MAN XS/1	DG002411		349.99
KUWAE SWIMSUIT BLACK/RED	2/3/4mm	MAN S/2	DG002412		349.99
KUWAE SWIMSUIT BLACK/RED	2/3/4mm	MAN M/3	DG002413		349.99
KUWAE SWIMSUIT BLACK/RED	2/3/4mm	MAN L/4	DG002414		349.99
KUWAE SWIMSUIT BLACK/RED	2/3/4mm	MAN XL/5	DG002415		349.99
KUWAE SWIMSUIT BLACK/RED	2/3/4mm	MAN 2XL/6	DG002416		349.99
KUWAE SWIMSUIT BLACK/LILAC	2/3/4mm	LADY XS/1	DG002611		349.99
KUWAE SWIMSUIT BLACK/LILAC	2/3/4mm	LADY S/2	DG002612		349.99
KUWAE SWIMSUIT BLACK/LILAC	2/3/4mm	LADY M/3	DG002613		349.99
KUWAE SWIMSUIT BLACK/LILAC	2/3/4mm	LADY L/4	DG002614		349.99
KUWAE SWIMSUIT BLACK/LILAC	2/3/4mm	LADY XL/5	DG002615		349.99

KUWAE

SWIM MONOPIECE WETSUIT 2 mm

The new Cressi swimming suit is inspired by the underwater caldera Kuwae, located in the Vanuatu archipelago in the South Pacific Ocean. The fluorescent colour of the upper part of the wetsuit recalls the lava of the volcanic eruption, as does the truly explosive design. This particular colour was also chosen to give the swimmer maximum visibility when in open water. Kuwae has been entirely designed with the help of sophisticated 3D software for the modelling of wetsuits, which made it possible to study the fitting of the materials and the different sizes on virtual mannequins. In this way, Cressi not only

facilitates an innovative approach to research and development, but also obtains a positive environmental impact by eliminating unnecessary sample collections. The 2.0 mm high-density Hyperstretch neoprene optimizes comfort, provides UV protection, and protects swimmers against scratches while ensuring complete freedom of movement. The smooth exterior finish and the Glide Skin XT waterproof treatment guarantee exceptional hydrodynamics. The new low neckline design has been studied to avoid any friction around the neck, while

- THICKNESS 2 MM
- BACK ZIP
- UV PROTECTION
- QUICK DRYING
- HYPERSTRETCH NEOPRENE

maintaining a perfect seal against water infiltration. On the inner part of the under-zip panel you can customize the wetsuit with your name and stash a key for any means of transport in the special pocket. The YKK back zip guarantees tightness and durability over time: the slider is made of anti-corrosion metal material, to ensure greater sturdiness when pulling the lanyard to zip/unzip the wetsuit.



SWIM HOOD INCLUDED WITH EACH PURCHASED WETSUIT



TECHNICAL FEATURES

- The ultimate swimming wetsuit
- Completely designed with a sophisticated 3d modelling software
- Graphics inspired by underwater volcanic eruption
- Maximum visibility for the swimmer when in open water
- Back zip

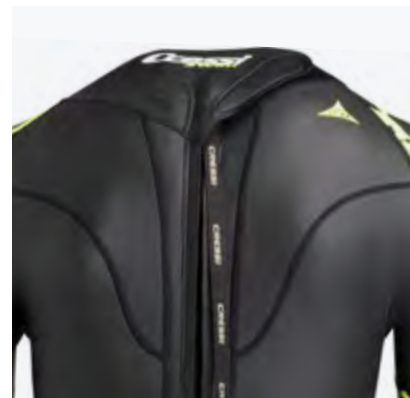

PRODUCT	THK	SIZE	CODE		RRP €
KUWAE SWIMSUIT BLACK/GREEN	2 mm	MAN XS/1	DG002701		289,99
KUWAE SWIMSUIT BLACK/GREEN	2 mm	MAN S/2	DG002702		289,99
KUWAE SWIMSUIT BLACK/GREEN	2 mm	MAN M/3	DG002703		289,99
KUWAE SWIMSUIT BLACK/GREEN	2 mm	MAN L/4	DG002704		289,99
KUWAE SWIMSUIT BLACK/GREEN	2 mm	MAN XL/5	DG002705		289,99
KUWAE SWIMSUIT BLACK/GREEN	2 mm	MAN 2XL/6	DG002706		289,99
KUWAE SWIMSUIT BLACK/ORANGE	2 mm	LADY XS/1	DG002801		289,99
KUWAE SWIMSUIT BLACK/ORANGE	2 mm	LADY S/2	DG002802		289,99
KUWAE SWIMSUIT BLACK/ORANGE	2 mm	LADY M/3	DG002803		289,99
KUWAE SWIMSUIT BLACK/ORANGE	2 mm	LADY L/4	DG002804		289,99

KARUA

MULTI THICKNESS MONOPIECE WETSUIT 3+2 mm

The new Cressi hybrid wetsuit is inspired by the underwater caldera Karua, located in the Vanuatu archipelago in the South Pacific Ocean. The graphics at the wetsuit's sleeves recall the lava of the volcanic eruption. The fluorescent-coloured sleeves, the upper back panel, and the ankles give maximum visibility when in open water. Karua has been entirely designed with the help of sophisticated 3D software for the modelling of wetsuits, which made it possible to study the fitting of the materials and the different sizes on virtual mannequins. In this way, Cressi not only facilitates an innovative approach to research

and development, but also obtains a positive environmental impact by eliminating unnecessary sample collections.

Both the exterior and interior are smooth, comfortable and durable nylon-covered 3mm Ultrastretch neoprene, which provides a great flexibility, UV protection, and protects swimmers against scratches while ensuring complete freedom of movement. The perfect thin hybrid wetsuit for those who are looking for a suit for swimming, snorkelling, surfing, paddling, canyoning, and all other experiences in the water. The new low neckline design with the 2mm Glide

Skin XT neoprene has been studied to avoid any friction around the neck, while maintaining a perfect seal against water infiltration. On the inner part of the under-zip panel, you can customize the wetsuit with your name and stash a key for any means of transport in the special pocket. The YKK back zip guarantees tightness and durability over time: the slider is made of anti-corrosion metal material, to ensure greater sturdiness when pulling the lanyard to zip/unzip the wetsuit.



TECHNICAL FEATURES

- The ultimate swimming wetsuit
- Completely designed with a sophisticated 3d modelling software
- Graphics inspired by underwater volcanic eruption
- Maximum visibility for the swimmer when in open water
- Back zip
- Different thicknesses (2-3 mm)



PRODUCT	THK	SIZE	CODE		RRP €
KARUA SWIMSUIT BLACK/LIME	3/2 mm	MAN XS/1	DG002901		199,99
KARUA SWIMSUIT BLACK/LIME	3/2 mm	MAN S/2	DG002902		199,99
KARUA SWIMSUIT BLACK/LIME	3/2 mm	MAN M/3	DG002903		199,99
KARUA SWIMSUIT BLACK/LIME	3/2 mm	MAN L/4	DG002904		199,99
KARUA SWIMSUIT BLACK/LIME	3/2 mm	MAN XL/5	DG002905		199,99
KARUA SWIMSUIT BLACK/LIME	3/2 mm	MAN 2XL/6	DG002906		199,99
KARUA SWIMSUIT BLACK/TURQUOISE	3/2 mm	LADY XS/1	DG003001		199,99
KARUA SWIMSUIT BLACK/TURQUOISE	3/2 mm	LADY S/2	DG003002		199,99
KARUA SWIMSUIT BLACK/TURQUOISE	3/2 mm	LADY M/3	DG003003		199,99
KARUA SWIMSUIT BLACK/TURQUOISE	3/2 mm	LADY L/4	DG003004		199,99

TRITON

MONOPIECE WETSUIT 1.5 mm

Wetsuit made of 1.5 mm neoprene ULTRASKIN for swimming in open water. For safety, it has a special insert in the forearms, fluorescent green for men or fluorescent

orange for women, that allows immediate sighting during the activity. It also features a key pocket and a label for a name.

THICKNESS 1.5 MM | BACK ZIP | UV PROTECTION | QUICK DRYING | SUPER STRETCH

TECHNICAL FEATURES

- Designed for optimizes comfort and prevents scraping
- 1.5 mm high density neoprene
- Smooth exterior finish and Glide Skin water-proof treatment
- Exceptional hydrodynamics

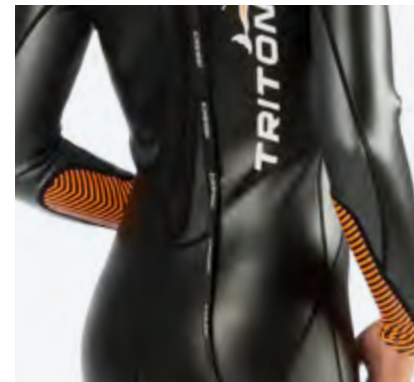

HIGH VISIBILITY PADS



ANTI-SEEPAGE COLLAR



PRODUCT	THK	SIZE	CODE		RRP €
TRITON SWIMSUIT BLACK/GREEN	1.5 mm	MAN XS/1	DG002201		249.99
TRITON SWIMSUIT BLACK/GREEN	1.5 mm	MAN S/2	DG002202		249.99
TRITON SWIMSUIT BLACK/GREEN	1.5 mm	MAN M/3	DG002203		249.99
TRITON SWIMSUIT BLACK/GREEN	1.5 mm	MAN L/4	DG002204		249.99
TRITON SWIMSUIT BLACK/GREEN	1.5 mm	MAN XL/5	DG002205		249.99
TRITON SWIMSUIT BLACK/GREEN	1.5 mm	MAN 2XL/6	DG002206		249.99
TRITON SWIMSUIT BLACK/ORANGE	1.5 mm	LADY XS/1	DG002301		249.99
TRITON SWIMSUIT BLACK/ORANGE	1.5 mm	LADY S/2	DG002302		249.99
TRITON SWIMSUIT BLACK/ORANGE	1.5 mm	LADY M/3	DG002303		249.99
TRITON SWIMSUIT BLACK/ORANGE	1.5 mm	LADY L/4	DG002304		249.99

SWIM HOOD

2 mm

THICKNESS 2 MM | HIGH VISIBILITY STRIPES

PRODUCT	THK	SIZE	CODE		RRP €
SWIM HOOD	2 mm	S/M	DG002397		29.99
SWIM HOOD	2 mm	L/XL	DG002398		29.99

TERMICO

NEOPRENE SWIMSUIT, LONG SLEEVES 2 mm

Women's all-in-one suit that is shaped like a one-piece swimsuit in soft 2 mm neoprene. Designed specifically for swimming, snorkeling and water sports in general, it allows great freedom of movement thanks to the special style and elasticity of the material. It is made from double lined 2 mm neoprene and comes with a front zip that makes it easy to put on and take off.

2-MM ULTRAS-PAN LINED NEOPRENE

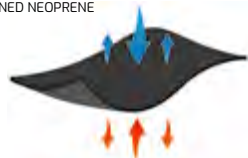

THICKNESS 2 MM | FRONT ZIP | SUPER STRETCH

PRODUCT	THK	SIZE	CODE	RRP €
TERMICO LONG/SL LADY SWIMSUIT PINK/WHITE	2 mm	XS/1	XDG0001011	119.99
TERMICO LONG/SL LADY SWIMSUIT PINK/WHITE	2 mm	S/2	XDG0001012	119.99
TERMICO LONG/SL LADY SWIMSUIT PINK/WHITE	2 mm	M/3	XDG0001013	119.99
TERMICO LONG/SL LADY SWIMSUIT PINK/WHITE	2 mm	L/4	XDG0001014	119.99
TERMICO LONG/SL LADY SWIMSUIT PINK/WHITE	2 mm	XL/5	XDG0001015	119.99
TERMICO LONG/SL LADY SWIMSUIT PINK/WHITE	2 mm	2XL/6	XDG0001016	119.99

TERMICO

NEOPRENE SWIMSUIT 2 mm

Women's all-in-one suit that is shaped like a one-piece swimsuit in soft 2 mm neoprene. Designed specifically for swimming, snorkeling and water sports in general, it allows great freedom of movement thanks to the special style and elasticity of the material. It is made from double lined 2 mm neoprene and comes with a front zip that makes it easy to put on and take off.

2-MM ULTRAS-PAN LINED NEOPRENE

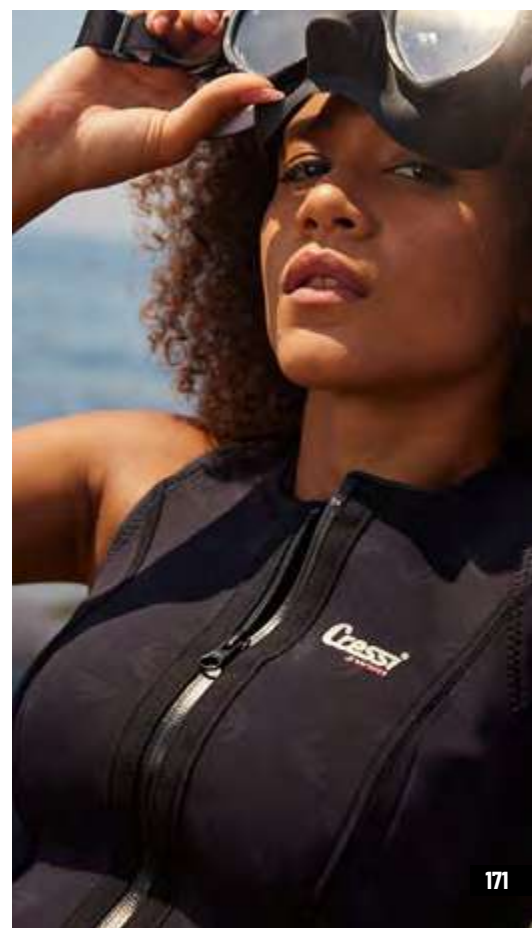
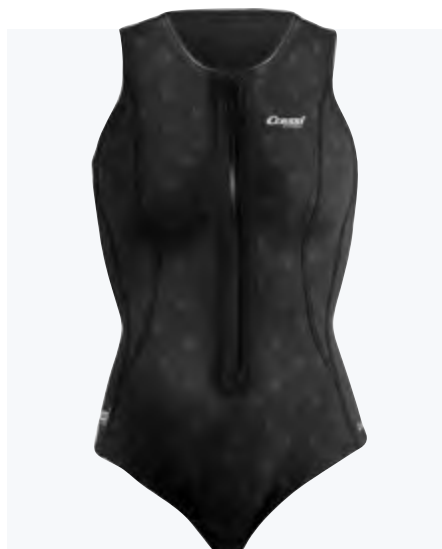
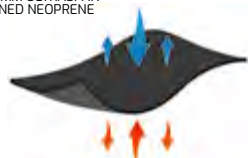

THICKNESS 2 MM | FRONT ZIP | SUPER STRETCH

PRODUCT	THK	SIZE	CODE	RRP €
TERMICO LADY SWIMSUIT BLACK	2 mm	XS/1	DG000501	99.99
TERMICO LADY SWIMSUIT BLACK	2 mm	S/2	DG000502	99.99
TERMICO LADY SWIMSUIT BLACK	2 mm	M/3	DG000503	99.99
TERMICO LADY SWIMSUIT BLACK	2 mm	L/4	DG000504	99.99
TERMICO LADY SWIMSUIT BLACK	2 mm	XL/5	DG000505	99.99

DEA

NEOPRENE SWIMSUIT 1 mm

THICKNESS 1 MM | ZIPLESS DESIGN | SUPER STRETCH

TECHNICAL FEATURES

- Anatomically designed to give women maximum comfort and wearability
- Elegant, without zipper
- 100% Ultrastretch
- Upper part in smooth neoprene inside
- Suitable for open water, swimming pool and aquagym

2-MM ULTRASPAN LINED NEOPRENE

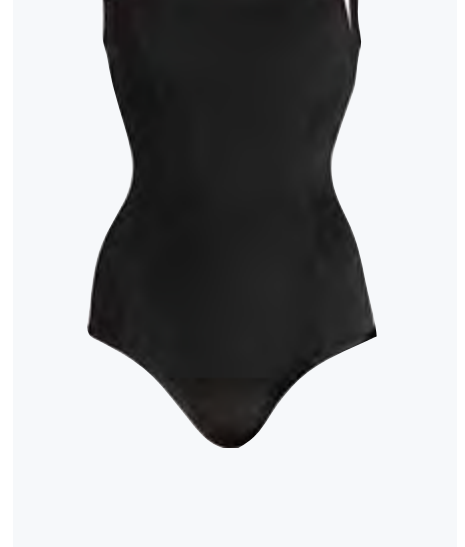
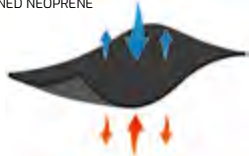

PRODUCT	THK	SIZE	CODE	RRP €
DEA NEOPRENE SWIMSUIT BLACK/BLACK	1 mm	XS/1	DG005401	89,99
DEA NEOPRENE SWIMSUIT BLACK/BLACK	1 mm	S/2	DG005402	89,99
DEA NEOPRENE SWIMSUIT BLACK/BLACK	1 mm	M/3	DG005403	89,99
DEA NEOPRENE SWIMSUIT BLACK/BLACK	1 mm	L/4	DG005404	89,99
DEA NEOPRENE SWIMSUIT BLACK/BLACK	1 mm	XL/5	DG005405	89,99

TERMICO MAN

SHORTY NEOPRENE SWIMSUIT 2 mm

THICKNESS 2 MM | FRONT ZIP | SUPER STRETCH

Thermal comfort shorty for swimming, in highly elastic 2-mm Ultraspan lined neoprene. Glide-skin anti-friction treatment in the underarm area. Glide-skin anti-seepage seals at the neck and legs.

2-MM ULTRASPAN LINED NEOPRENE

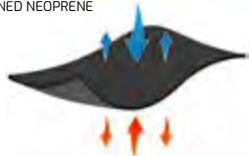

PRODUCT	THK	SIZE	CODE	RRP €
TERMICO MAN SHORTY BLACK/RED	2 mm	S/2	XDG000912	169,99
TERMICO MAN SHORTY BLACK/RED	2 mm	M/3	XDG000913	169,99
TERMICO MAN SHORTY BLACK/RED	2 mm	L/4	XDG000914	169,99
TERMICO MAN SHORTY BLACK/RED	2 mm	XL/5	XDG000915	169,99
TERMICO MAN SHORTY BLACK/RED	2 mm	2XL/6	XDG000916	169,99

/ WETSUITS SIZE CHART

WETSUITS SIZE CHARTS

- Dry suits
- Semi-dry suits
- Monopieces
- Two-pieces (Jacket + Pants)
- Shorties

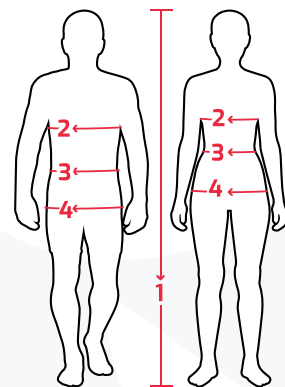

		WEIGHT		(1) HEIGHT		(2) CHEST		(3) WAIST		(4) HIP		FOOT			
		Size	kg	lbs	cm	in	cm	in	cm	in	cm	in	EU	UK	US
DRY SUIT MEN	S-II-48	60-68	132-150	164-170	65-67	78-83	31-33	65-71	25-28	78-83	31-33	40-42	7-8	7.5-8.5	
	M-III-50	70-78	154-172	169-175	67-69	86-91	34-36	71-77	28-30	84-89	33-35	41-43	7.5-8.5	8-9	
	L-IV-52	80-88	176-194	174-180	69-71	94-99	37-39	77-83	30-33	90-95	35-37	42-44	8-10	8.5-10.5	
	XL-V-54	90-98	198-216	179-185	71-73	102-107	40-42	83-89	33-35	96-101	38-40	43-45	8.5-11	9-11.5	
	XXL-VI-56	100-108	220-238	184-190	73-75	110-115	43-45	89-95	35-37	102-107	40-42	44-46	10-11.5	10.5-12	
	XXXL-VII-58	105-115	231-254	191-198	75-78	118-123	46-48	95-101	37-40	108-113	43-45	45-47	-	-	
DRY SUIT WOMEN	XS-I-42	47-52	104-115	157-162	62-64	77-82	30-32	56-61	22-24	83-87	32-34	37-39	4.5-6.5	5-7	
	S-II-44	53-58	117-128	162-167	64-66	82-87	32-34	60-65	24-26	87-91	34-36	38-40	5.5-7	6-7.5	
	M-III-46	59-64	130-141	167-172	66-68	87-92	34-36	64-69	25-27	91-95	36-37	39-41	6.5-7.5	7-8	
	L-IV-48	64-70	141-154	172-177	68-70	92-97	36-38	68-73	27-29	95-99	37-39	40-42	7-8	7.5-8.5	
	XL-V-50	70-80	154-176	177-182	70-72	97-102	38-40	72-77	28-30	99-103	39-41	41-43	7.5-8.5	8-9	
SEMI DRY, MONOPIECE, TWO-PIECE, WETSUIT MEN	S-II-48	60-68	132-150	164-173	65-68	78-83	31-33	65-71	25-28	78-83	31-33	-	-	-	
	M-III-50	70-78	154-172	169-178	67-70	86-91	34-36	71-77	28-30	84-89	33-35	-	-	-	
	L-IV-52	80-88	176-194	174-183	69-72	94-99	37-39	77-83	30-33	90-95	35-37	-	-	-	
	XL-V-54	90-98	198-216	179-188	71-74	102-107	40-42	83-89	33-35	96-101	38-40	-	-	-	
	XXL-VI-56	100-108	220-238	184-193	72-76	110-115	43-45	89-95	35-37	102-107	40-42	-	-	-	
	XXXL-VII-58	105-115	231-254	191-198	75-78	118-123	46-48	95-101	37-40	108-113	43-45	-	-	-	
SEMI DRY, MONOPIECE, TWO-PIECE, WETSUIT WOMEN	XS-I-40	47-52	104-115	160-165	63-65	77-82	30-32	56-61	22-24	83-87	32-34	-	-	-	
	S-II-42	53-58	117-128	165-170	65-67	82-87	32-34	60-65	24-26	87-91	34-36	-	-	-	
	M-III-44	59-64	130-141	170-175	67-69	87-92	34-36	64-69	25-27	91-95	36-37	-	-	-	
	L-IV-46	64-70	141-154	175-180	69-71	92-97	36-38	68-73	27-29	95-99	37-39	-	-	-	
	XL-V-48	70-80	154-176	180-185	71-73	97-102	38-40	72-77	28-30	99-103	39-41	-	-	-	
SHORTY WETSUIT MEN	XS-I-46	50-58	110-128	156-165	61-65	70-75	28-30	59-65	23-26	72-77	28-30	-	-	-	
	S-II-48	60-68	132-150	164-173	65-68	78-83	31-33	65-71	26-28	78-83	31-33	-	-	-	
	M-III-50	70-78	154-172	169-178	67-70	86-91	34-36	71-77	28-30	84-89	33-35	-	-	-	
	L-IV-52	80-88	176-194	174-183	69-72	94-99	37-39	77-83	30-33	90-95	35-37	-	-	-	
	XL-V-54	90-98	198-216	179-188	71-74	102-107	40-42	83-89	33-35	96-101	38-40	-	-	-	
	XXL-VI-56	100-108	220-238	184-193	72-76	110-115	43-45	89-95	35-37	102-107	40-42	-	-	-	
SHORTY WETSUIT WOMEN	XS-I-40	47-52	104-115	160-165	63-65	77-82	30-32	56-61	22-24	83-87	32-34	-	-	-	
	S-II-42	53-58	117-128	165-170	65-67	82-87	32-34	60-65	24-26	87-91	34-36	-	-	-	
	M-III-44-46	59-64	130-141	170-175	67-69	87-92	34-36	64-69	25-27	91-95	36-37	-	-	-	
	L-IV-48-50	64-70	141-154	175-180	69-71	92-97	36-38	68-73	27-29	95-99	37-39	-	-	-	
NEOPRENE-LYCRA, MONOPIECE, SHORTY WETSUIT MEN	S	-	-	-	-	84.5-87.5	33.2-34.4	67.5-70.5	26.5-27.5	81.5-84.5	32-33.2	-	-	-	
	M	-	-	-	-	88.5-91.5	34.8-36	71.5-74.5	28.1-29.3	85.5-88.5	33.6-34.8	-	-	-	
	L	-	-	-	-	93.5-96.5	36.8-37.9	76.5-79.5	30.1-31.2	90.5-93.5	35.6-36.8	-	-	-	
	XL	-	-	-	-	98.5-101.5	38.7-39.9	81.5-84.5	32-33.2	95.5-98.5	37.5-38.7	-	-	-	
	XXL	-	-	-	-	103.5-106.5	40.7-41.9	86.5-89.5	34-35.2	100.5-103.5	39.5-40.7	-	-	-	
NEOPRENE-LYCRA, MONOPIECE, SHORTY WETSUIT WOMEN	XS	-	-	-	-	72.5-75.5	28.5-29.7	58.5-61.5	23-24.2	80.5-83.5	31.6-34.8	-	-	-	
	S	-	-	-	-	76.5-79.5	30.1-31.2	61.5-64.5	24.2-25.3	83.5-86.5	32.8-34	-	-	-	
	M	-	-	-	-	80.5-83.5	31.6-34.8	65.5-68.5	25.7-26.9	87.5-90.5	34.4-35.6	-	-	-	
	L	-	-	-	-	85.5-88.5	33.6-34.8	68.5-71.5	26.9-28.1	91.5-94.5	36-37	-	-	-	
	XL	-	-	-	-	90.5-93.5	35.6-36.8	71.5-74.5	28.1-29.3	94.5-97.5	37-38.3	-	-	-	

GUARDIAN NEOPRENE JACKET

NEW 2025

NEOPRENE JACKET 2MM

The Guardian Neoprene Jacket for adults is crafted from high-quality, 2mm double-lined elastic neoprene with flatlock stitching, making it more flexible, comfortable, soft, and durable. This jacket offers an incredibly stretchy, comfortable, and snug fit for swimming, snorkeling, and other water sports. It provides excellent sun protection and helps prevent injuries. The long-sleeve design shields you from sunburn and abrasions. Featuring a front YKK plastic zipper, the jacket is easy to put on and take off. It conforms to your body, offering greater freedom of movement, making it the perfect choice for all your aquatic adventures.



PRODUCT	THK	SIZE	CODE		RRP €
JACKET	2 mm	MAN S/2	LW481522		69.99
JACKET	2 mm	MAN M/3	LW481523		69.99
JACKET	2 mm	MAN L/4	LW481524		69.99
JACKET	2 mm	MAN XL/5	LW481525		69.99
JACKET	2 mm	MAN 2XL/6	LW481526		69.99
JACKET	2 mm	MAN 3XL/7	LW481527		69.99
JACKET	2 mm	LADY XS/1	LW482521		69.99
JACKET	2 mm	LADY S/2	LW482522		69.99
JACKET	2 mm	LADY M/3	LW482523		69.99
JACKET	2 mm	LADY L/4	LW482524		69.99
JACKET	2 mm	LADY XL/5	LW482525		69.99



WATERSPORTS
NEOPRENE

Photo by: Luca Meola

GUARDIAN NEOPRENE VEST

NEW 2025

NEOPRENE GILET 2MM

The Guardian Neoprene Gilet for adults is crafted from high-quality, 2mm double-lined elastic neoprene with flatlock stitching, making it more flexible, comfortable, soft, and durable. This gilet offers an incredibly stretchy, comfortable, and snug fit for swimming, snorkeling, and other water sports. It provides excellent sun protection and helps prevent injuries. The sleeveless design ensures full range of motion while shielding your core from sunburn and abrasions. Featuring a front YKK plastic zipper, the gilet is easy to put on and take off. It conforms to your body, offering greater freedom of movement, making it perfect for all your aquatic adventures.



PRODUCT	THK	SIZE	CODE	RRP €
GILET	2 mm	MAN S/2	LW490522	49,99
GILET	2 mm	MAN M/3	LW490523	49,99
GILET	2 mm	MAN L/4	LW490524	49,99
GILET	2 mm	MAN XL/5	LW490525	49,99
GILET	2 mm	MAN 2XL/6	LW490526	49,99
GILET	2 mm	MAN 3XL/7	LW490527	49,99
GILET	2 mm	LADY XS/1	LW491521	49,99
GILET	2 mm	LADY S/2	LW491522	49,99
GILET	2 mm	LADY M/3	LW491523	49,99
GILET	2 mm	LADY L/4	LW491524	49,99
GILET	2 mm	LADY XL/5	LW491525	49,99



GUARDIAN NEOPRENE PANTS

NEW 2025

NEOPRENE PANTS 2MM

The Guardian Neoprene Pants for adults are crafted from high-quality, 2mm double-lined elastic neoprene with flatlock stitching, making them flexible, comfortable, soft, and durable. These pants offer an incredibly stretchy, snug fit for swimming, snorkeling, and other water sports. They provide excellent sun protection and help prevent injuries. The adjustable waistband ensures a secure and personalized fit, enhancing comfort and freedom of movement. Designed to conform to your body, these pants are perfect for all your aquatic adventures, offering superior flexibility and protection in any water activity.



PRODUCT	THK	SIZE	CODE	RRP €
PANTS	2 mm	MAN S/2	LW500522	59,99
PANTS	2 mm	MAN M/3	LW500523	59,99
PANTS	2 mm	MAN L/4	LW500524	59,99
PANTS	2 mm	MAN XL/5	LW500525	59,99
PANTS	2 mm	MAN 2XL/6	LW500526	59,99
PANTS	2 mm	MAN 3XL/7	LW500527	59,99
PANTS	2 mm	LADY XS/1	LW501521	59,99
PANTS	2 mm	LADY S/2	LW501522	59,99
PANTS	2 mm	LADY M/3	LW501523	59,99
PANTS	2 mm	LADY L/4	LW501524	59,99
PANTS	2 mm	LADY XL/5	LW501525	59,99

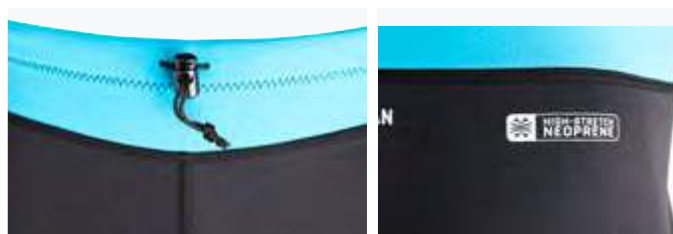

AFTER DIVE ACCESSORIES



Photo by: Theo Knevel

QUICKCHANGE MAT

NEW 2025

CARRY
WETSUIT BAG

QUICK
FOLDING

WATERPROOF

QUICK
DRYING

SOFT SHELL CHANGING MAT

Cressi Quick Change is a changing mat, designed specifically to allow you to remove wetsuits and swimsuits. This accessory will prove incredibly useful if you engage in water sports and can be easily carried with you anywhere, thanks to its compact folding capability. With a diameter of 70cm, the changing mat offers ample space to accommodate your equipment. The inner towel

measures 40x40cm, providing a soft surface for added comfort during changing. Perfectly tailored for watersport activities, this changing mat is a must-have for surfers, divers, and all water enthusiasts. The Change Mat conveniently transforms into a practical bag with handles, making it easy to transport.



PRODUCT	CODE	RRP €
QUICKCHANGING MAT BLACK/YELLOW	NE001051	39.99

PONCHO

NEW DESIGN 2025

QUICK
DRYING

100%
MICROFIBER

PREMIUM UNISEX TOWEL

The restyled Cressi Poncho is made from quick-dry microfiber, this changing towel is designed to make transitioning out of a wetsuit or swimsuit a breeze. The Cressi Poncho offers ample coverage, allowing for easy and comfortable changing after your water activities. Featuring a spacious hood, wide sleeves, and knee-length design, the poncho not only keeps you warm but also

provides unrestricted freedom of movement. To enhance functionality, the Cressi Poncho is equipped with a large, comfortable pocket on the front. With its unisex design, the Cressi Poncho is suitable for both men and women. It offers a versatile fit that accommodates various body types, ensuring a comfortable and secure experience for all users. Two colors available.



BLACK



BLUE NAVY



SIZE	BLUE NAVY	BLACK	RRP €
S/M	XVA911000	XVA914000	49.99
M/L	XVA912000	XVA915000	49.99
L/XL	XVA913000	XVA916000	49.99



/ AFTER DIVE ACCESSORIES

BATHROBE NEW 2025

QUICK DRYING | 100% COTTON

PREMIUM UNISEX TOWEL

Cressi cotton Bathrobe features a comfortable fit, ensuring freedom of movement and ease of wearing. With its absorbent nature, this cotton bathrobe effortlessly wicks away moisture, leaving

you feeling dry and cozy. Its design includes a hood and long sleeves, providing an extra touch of warmth. Available in black and blue, unisex style and more sizes available.



BLACK

BLUE NAVY



SIZE	BLUE NAVY/WHITE	BLACK/YELLOW	RRP €
S/M	XVA920232	XVA920512	49,99
L/XL	XVA920234	XVA920514	49,99
2XL/3XL	XVA920236	XVA920516	49,99



SEA SOUL NEW 2025

SEA FRIENDLY | 250ML | 500ML

SALTWATER AND FRESHWATER FRIENDLY SHAMPOO+SHOWER GEL

Cressi Sea Soul is a natural and eco-friendly shampoo & shower gel that not only nourishes your hair and skin but also helps protect our precious seas. Formulated with care, this product is perfect for use on boats. Carefully crafted using natural ingredients to ensure a gentle and refreshing cleansing experience. It contains the goodness of Irish moss and aloe vera, known for their moisturizing and soothing properties. These ingredients help hydrate and revitalize your hair and skin, leaving them feeling soft, healthy, and rejuvenated. What sets Sea Soul apart is its commitment to environmental sustainability. This formula is created to minimize its impact on aquatic ecosystems, making it an excellent choice for those who care about protecting our seas. Available in two formats: 250ml, 500ml



NEO CLEAN NEW 2025

SEA FRIENDLY | 5000ML | 500ML

NEOPRENE & WETSUIT CLEANER

The Cressi Neo Cleaner is Provided in a "user" or "rental" container of 500ml or 5000ml. It's a low acid detergent (PH 5.5) useful to clean the neoprene elements and to wear microporous suits avoiding skin irritations. This formula is created to minimize its impact on aquatic ecosystems, making it an excellent choice for those who care about protecting our seas.



PRODUCT	CODE	RRP €
250ml	NE000025	12,99
500ml	NE000050	19,99

PRODUCT	CODE	RRP €
500ml	DG990005	19,99
5000ml	DG990015	79,99

CAR SEAT COVER NEW 2025

CAR SEAT - WATER PROTECTION

The Cressi hydro-repellent seat cover is the perfect solution to protect your car seats after engaging in water sports activities. Designed with functionality in mind, this seat cover ensures that your seats stay dry and protected. The universal fit design ensures compatibility with most car seats. The seat cover is equipped with adjustable straps on the sides, allowing you to securely fasten it and ensure a tight and snug fit. It features multiple pockets that offer convenient storage for various items. Keep your car seats dry, protected, and organized with this versatile and practical solution.



PRODUCT	CODE		RRP €
CAR SEAT COVER BLACK/YELLOW	NE002051		49.99

DRY WETSUIT BAG

Practical dry or wet suit bag. Can be completely opened and used as a changing mat so as to avoid contact with the ground.

Dimensions	70 x 50 x 5 cm 29.55 x 20.49 x 1.97 inch
-------------------	---



PRODUCT	CODE		RRP €
BAG FOR DRY SUIT	UB953000		39.99

BEACH PREMIUM TOWEL

QUICK DRYING | 100% COTTON

Material	100% Cotton
Dimensions	180 x 80 cm 70,8 x 31,5 inch

- Comfortable and durable
- Suitable for shower, swimming
- Simple and classic Design
- No harmful chemicals and synthetic materials are added
- Machine washable



SIZE	CODE		RRP €
180x80cm	XVA906810		29.99

CEMENT

NEOPRENE GLUE

DESCRIPTION:
Neoprene repairing glue, 30 gr



PRODUCT	CODE		RRP €
CEMENT	TA650000		9,99

PARAFFIN

STICK FOR METALLIC ZIP

DESCRIPTION:
Cylindrical paraffin stick to protect metallic zips of dry or semi dry suits.



PRODUCT	CODE		RRP €
SHAMPOO + SHOWER GEL	HZ704100		9,99



Photo by: Voyages of Agape



Photo by: Voyages of Agape

PVC GLUE

POLYURETHANE ADHESIVE

DESCRIPTION:
Polyurethane adhesive for pvc patches, ideal for puncture repairing, 30 ml.



PRODUCT	CODE		RRP €
PVC GLUE	NZ000400		12.99

MULTIPURPOSE HANGER

NEW 2025

DESCRIPTION:
High-strength hanger for carrying and storing wetsuits or neoprene garments



PRODUCT	CODE		RRP €
MULTIPURPOSE HANGER	TA700050		24.99

NEOPRENE ACCESSORIES

CRESSI
SINCE 1944

5
mm



Photo by: Theo Knevel

ORUST

HOOD 5 mm

Hood with an oversized crew neck that allows a better water tightness for those who want to use it by inserting it under the neck of the wetsuit. It is particularly suitable for one-piece wetsuits with a front zip. Anatomical cut. 100% high-stretch material. 3 mm smooth skin with watertight seals around the face and the neck.

THICKNESS 5 MM | 100% HIGH STRETCH MATERIAL



PRODUCT	THK	SIZE	CODE	SIZE	RRP €
ORUST HOOD	5 mm	UNISEX S/2	LS601502		59,99
ORUST HOOD	5 mm	UNISEX M/3	LS601503		59,99
ORUST HOOD	5 mm	UNISEX L/4	LS601504		59,99
ORUST HOOD	5 mm	UNISEX XL/5	LS601505		59,99
ORUST HOOD	5 mm	UNISEX 2XL/6	LS601506		59,99

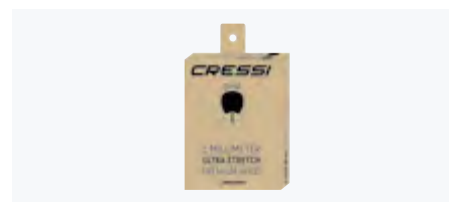

DRAGET PLUS ULTRA STRETCH

NEOPRENE HOOD 5 mm

Neoprene hood with integrated hook

ULTRA STRETCH NEOPRENE | THICKNESS 5 MM | INTEGRATED HOOD HOLDER



PRODUCT	THK	SIZE	CODE	SIZE	RRP €
HOOD DRAGET PLUS	5 mm	MAN S/2	LS550601		39,99
HOOD DRAGET PLUS	5 mm	MAN M/3-4	LS550602		39,99
HOOD DRAGET PLUS	5 mm	MAN L/5-6-7	LS550603		39,99
HOOD DRAGET PLUS	5 mm	LADY XS/0	LS551200		39,99
HOOD DRAGET PLUS	5 mm	LADY S/2-2	LS551201		39,99
HOOD DRAGET PLUS	5 mm	LADY M/4-4	LS551202		39,99



DRAGET

HOOD 5 mm, 3 mm

Neoprene hood available in two different thickness: 5 mm or 3 mm.

AVAILABLE IN TWO THICKNESS: 5 OR 3 MM



THK	SIZE	CODE	RRP €
5 mm	MAN S/2	LR107401	34.99
5 mm	MAN M/3-4	LR107402	34.99
5 mm	MAN L/5-6-7	LR107403	34.99
5 mm	LADY XS/0	LR107500	34.99
5 mm	LADY S/2-2	LR107501	34.99
5 mm	LADY M/4-4	LR107502	34.99
3 mm	UNISEX XS	LR108001	32.99
3 mm	UNISEX S	LR108002	32.99
3 mm	UNISEX M	LR108003	32.99
3 mm	UNISEX L	LR108004	32.99



RESILIENT HOOD W/ BIB

NEW 2025

ULTRA STRETCH NEOPRENE

THICKNESS 3 MM

NEOPRENE HOOD 3 mm

The Resilient hood is specifically engineered for underwater and aquatic environments. This hood is crafted from double-lined, soft, high-stretch neoprene, providing both exceptional comfort and lasting durability. Ideal for diving, snorkeling, and other water sports, the Resilient hood enhances your underwater experience.



PRODUCT	THK	SIZE	CODE	RRP €
RESILIENT LONG HOOD	3 mm	UNISEX S/2	L5603302	29.99
RESILIENT LONG HOOD	3 mm	UNISEX M/3	L5603303	29.99
RESILIENT LONG HOOD	3 mm	UNISEX L/4	L5603304	29.99
RESILIENT LONG HOOD	3 mm	UNISEX XL/5	L5603305	29.99
RESILIENT LONG HOOD	3 mm	UNISEX 2XL/6	L5603306	29.99

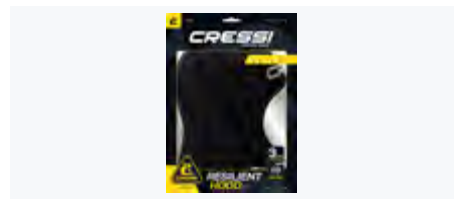

RESILIENT HOOD

NEW 2025

ULTRA STRETCH NEOPRENE

THICKNESS 3 MM

NEOPRENE HOOD 3 mm

The Resilient hood is specifically engineered for underwater and aquatic environments.

This hood is crafted from double-lined, soft, high-stretch neoprene, providing both exceptional comfort and lasting durability.

Ideal for diving, snorkeling, and other water sports, the Resilient hood enhances your underwater experience.



PRODUCT	THK	SIZE	CODE	RRP €
RESILIENT LONG HOOD	3 mm	UNISEX S/2	LS602302	24,99
RESILIENT LONG HOOD	3 mm	UNISEX M/3	LS602303	24,99
RESILIENT LONG HOOD	3 mm	UNISEX L/4	LS602304	24,99
RESILIENT LONG HOOD	3 mm	UNISEX XL/5	LS602305	24,99
RESILIENT LONG HOOD	3 mm	UNISEX 2XL/6	LS602306	24,99

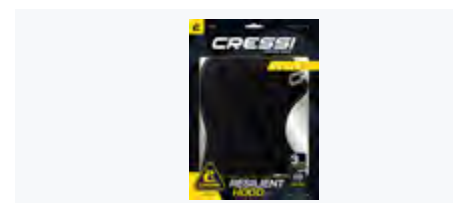

GUARDIAN PEAKED HOOD

NEW 2025

ULTRA STRETCH NEOPRENE

THICKNESS 2 MM

NEOPRENE HOOD 2 mm

The Peaked Hood Neoprene Cap is expertly designed for surface water environments and sports. Crafted from soft, high-elasticity double-lined neoprene, this hood provides exceptional comfort and long-lasting durability. It is perfect for various water sports, ensuring an enhanced experience with its practical features. The small visor is a standout design element, effectively shielding your eyes from the sun's rays and glare, allowing for better visibility and protection. Whether you're kayaking, surfing, or engaging in other aquatic activities, this hood ensures you stay comfortable and protected.



PRODUCT	THK	SIZE	CODE	RRP €
GUARDIAN PEAKED HOOD	2 mm	UNISEX S/2	LR109222	39,99
GUARDIAN PEAKED HOOD	2 mm	UNISEX M/3	LR109223	39,99
GUARDIAN PEAKED HOOD	2 mm	UNISEX L/4	LR109224	39,99
GUARDIAN PEAKED HOOD	2 mm	UNISEX XL/5	LR109225	39,99
GUARDIAN PEAKED HOOD	2 mm	UNISEX 2XL/6	LR109226	39,99

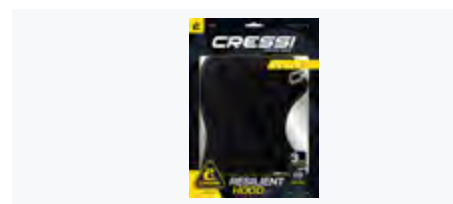

MALMO ROCK BOOTS

HARD SOLE NEOPRENE BOOTS 3 mm

- THICKNESS 3 MM
- RIGID HARD SOLE
- PU REINFORCED
- RAPID CLOSURE
EXCEPTIONAL COMFORT

The 3 mm neoprene Malmo boots offer reliable protection, outstanding performance and maximum comfort. A hard sole provides excellent grip on slippery surfaces and protection from stones and underwater obstacles. Aesthetically similar to trainers, they are the perfect combination of style and functionality. Wear-sensitive areas are reinforced with hard-wearing PU, ensuring durability. The practical lace-up allows for a quick and secure closure, while their unbeatable comfort allows you to concentrate only on your activities.

TECHNICAL FEATURES

- Total protection
- 3 mm thickness
- Maximum grip
- PU reinforcement for durability
- Outstanding performance and unbeatable comfort

SIZE	EU	CODE	RRP €
S	40-42	LX441302	89,99
M	41-43	LX441303	89,99
L	42-44	LX441304	89,99
XL	43-45	LX441305	89,99
2XL	44-46	LX441306	89,99
3XL	45-47	LX441307	89,99



KORSOR

REINFORCED SOLE NEOPRENE BOOTS 5 mm

- THICKNESS 5 MM
- RIGID REINFORCED SOLE

Boots designed to be used with open heel fins, are made of soft nylon-lined neoprene 5 mm, ideal for cooler waters. Reinforced pu protection for instep and heel provides resistance against wear and tear. The notch for holding fin strap is integrated into the heel. A practical ykk zipper opens at the ankle for easy donning. Water seepage is reduced to the minimum thanks to a protective thin flap hydro seal under zip. The Cressi personalized ankle strap has a velcro in the inner part. A rigid, non-slip and hi-grip moulding covers the entire sole.



SIZE	EU	CODE	RRP €
S	38-39	LX433401	99,99
M	40-41	LX433402	99,99
L	42-43	LX433403	99,99
XL	44-45	LX433404	99,99
2XL	46-47	LX433405	99,99



ULTRASPAN

ULTRA STRETCH NEOPRENE BOOTS 5 mm

Boots with non-slip soles are ideal for use with open heel fins. Reinforcements on the back of the foot and the heel provide protection against wear and tear.



THICKNESS
5 MM

SIZE	EU	CODE		RRP €
S	38-39	LX432701		59,99
M	40-41	LX432702		59,99
L	42-43	LX432703		59,99
XL	44-45	LX432704		59,99



ISLA

NEOPRENE BOOTS 3 mm, 5 mm, 7 mm

These boots are suitable for any kind of water sports to keep the feet warm. The back of the heel has a special design that fits perfectly with open heel fins for scuba diving. The small boss is used to prevent the slipping of the fins strap. Both the toe and the heel are reinforced with long-lasting rubber and provide protection against wear and tear. They are made from soft, double-lined neoprene and have a practical zip from the sole to the ankle, making them easy to slip on and off. Water seepage is reduced to the minimum thanks to a thin flap seal under the zip, which acts as an effective barrier against any water that may seep through the zip. A strong non-slip molding covers the entire sole.



THK	SIZE	EU	CODE		RRP €
3 mm	XS	36-37	LX432000		59,99
3 mm	S	38-39	LX432001		59,99
3 mm	M	40-41	LX432002		59,99
3 mm	L	42-43	LX432003		59,99
3 mm	XL	44-45	LX432004		59,99
3 mm	2XL	46-47	LX432005		59,99
5 mm	XS	36-37	LX432500		59,99
5 mm	S	38-39	LX432501		59,99
5 mm	M	40-41	LX432502		59,99
5 mm	L	42-43	LX432503		59,99
5 mm	XL	44-45	LX432504		59,99
5 mm	2XL	46-47	LX432505		59,99
7 mm	S	38-39	LX432601		64,99
7 mm	M	40-41	LX432602		64,99
7 mm	L	42-43	LX432603		64,99
7 mm	XL	44-45	LX432604		64,99
7 mm	2XL	46-47	LX432605		64,99



/ BOOTS

REEFTECH RS

NEW 2025

THICKNESS 5 MM RIGID HARD SOLE

REINFORCED SOLE NEOPRENE BOOTS 5 mm

Boots designed to be used with open heel fins, are made of soft nylon-lined neoprene 5 mm, ideal for cooler waters. Reinforced pu protection for instep and heel provides resistance against wear and tear. The notch for holding fin strap is integrated into the heel. A practical ykk zipper opens at the ankle for easy donning. Water seepage is reduced to the minimum thanks to a protective thin flap hydro seal under zip. The Cressi personalized ankle strap has a velcro in the inner part. A rigid, non-slip and hi-grip moulding covers the entire sole.



PRODUCT	CODE		RRP €
REEFTECH RS 5mm XS (EU 36/37)	LX439536		79.99
REEFTECH RS 5mm S (EU 38/39)	LX439538		79.99
REEFTECH RS 5mm M (EU 40/41)	LX439540		79.99
REEFTECH RS 5mm L (EU 42/43)	LX439542		79.99
REEFTECH RS 5mm XL (EU 44/45)	LX439544		79.99
REEFTECH RS 5mm 2XL (EU 46/47)	LX439546		79.99



REEFTECH

NEW 2025

NEOPRENE BOOTS 5 mm

These boots are suitable for any kind of water sports to keep the feet warm. The back of the sole has a special design that fits perfectly with open heel fins for scuba diving. Both the toe and the heel are reinforced with long-lasting rubber and provide protection against wear and tear. They are made from soft, double-lined neoprene and have a practical zip from the sole to the ankle, making them easy to slip on and off. Water seepage is reduced to the minimum thanks to a thin flap seal under the zip, which acts as an effective barrier against any water that may seep through the zip. A strong non-slip molding covers the entire sole.



PRODUCT	CODE		RRP €
REEFTECH 5mm XS (EU 36/37)	LX438536		49.99
REEFTECH 5mm S (EU 38/39)	LX438538		49.99
REEFTECH 5mm M (EU 40/41)	LX438540		49.99
REEFTECH 5mm L (EU 42/43)	LX438542		49.99
REEFTECH 5mm XL (EU 44/45)	LX438544		49.99
REEFTECH 5mm 2XL (EU 46/47)	LX438546		49.99



LOW BOOTS

NEW DESIGN 2025

THICKNESS
3 MM

LOW BOOTS 3 mm

3 mm neoprene boots, with non-slip soles, highly elastic and comfortable.



SIZE	EU	CODE		RRP €
XS	36-37	XLX430900		44,99
S	38-39	XLX430901		44,99
M	40-41	XLX430902		44,99
L	42-43	XLX430903		44,99
XL	44-45	XLX430904		44,99
2XL	46-47	XLX430905		44,99



Photo by: Kayleigh Burns & Cam Grant

ORATA

NEOPRENE SOCKS 2.5 mm

SMOOTH SKIN NEOPRENE | THICKNESS 2.5 MM

These are single-lined, thin, high stretch neoprene boots. The inner is lined in Metallite so they are easy to put on. The sole has an effective non-slip lining. They can be used with both closed foot fins to protect the skin from scratches and chafing, as well as with firm-soled boots, using open-heel fins.

SMOOTH SKIN NEOPRENE

ANTI-SLIP GRIP SOLE



SIZE	EU	CODE		RRP €
S	36-38	LX433001		29,99
M	39-40	LX433002		29,99
L	41-42	LX433003		29,99
XL	43-44	LX433004		29,99

ULTRASTRETCH

NEOPRENE SOCKS 1.5 mm

THICKNESS 1.5 MM | NON-SLIP SOLE

Created in extremely supple, 1.5 mm thick, double-lined Ultraspan neoprene, these boots have non-slip and anti-wear soles and an Aquastop sealin single-lined neoprene at the top.

SMOOTH SKIN NEOPRENE ON THE INTERNAL UPPER PART

ANTI-SLIP GRIP SOLE



SIZE	EU	GREY		RRP €
S	36-39	DF200030		39,99
M	40-42	DF200031		39,99
L	43-45	DF200032		39,99

GUARDIAN HIGH SOCKS

NEW 2025

THICKNESS 2 MM NON-SLIP SOLE

WATERSPORT NEOPRENE SOCKS WITH VELCRO STRAP 2 mm

The Guardian High Neoprene Socks are made from soft, stretchy, 2mm double-lined neoprene. Designed for aquatic and surface activities, these high socks feature a non-slip grip on the entire sole. The innovative cut ensures no irritating seams on the sole or top of the foot, enhancing comfort. A convenient rear pull tab aids in easy wearing, while a practical Velcro strap allows for adjustable fit, making them ideal for all water adventures.



ANTI-SLIP GRIP SOLE

SIZE	EU	THK	CODE	RRP €
XS	36-37	2 mm	XLX436201	24,99
S	38-39	2 mm	XLX436202	24,99
M	40-41	2 mm	XLX436203	24,99
L	42-43	2 mm	XLX436204	24,99
XL	44-45	2 mm	XLX436205	24,99
2XL	46-47	2 mm	XLX436206	24,99

GUARDIAN MID SOCKS

NEW 2025

THICKNESS 2MM NON-SLIP SOLE

WATERSPORT NEOPRENE SOCKS WITH VELCRO STRAP 2 mm

The Guardian Mid-High Neoprene Socks are made from soft, stretchy, 2mm double-lined neoprene. Designed for aquatic and surface activities, these high socks feature a non-slip grip on the entire sole. The innovative cut ensures no irritating seams on the sole or top of the foot, enhancing comfort. A convenient rear pull tab aids in easy wearing, while a practical Velcro strap allows for adjustable fit, making them ideal for all water adventures.



ANTI-SLIP GRIP SOLE

SIZE	EU	THK	CODE	RRP €
XS	36-37	2 mm	XLX437201	24,99
S	38-39	2 mm	XLX437202	24,99
M	40-41	2 mm	XLX437203	24,99
L	42-43	2 mm	XLX437204	24,99
XL	44-45	2 mm	XLX437205	24,99
2XL	46-47	2 mm	XLX437206	24,99

RESILIENT PRO WITH GRIP

NEW 2025

THICKNESS 3 MM | NON-SLIP SOLE

NEOPRENE SOCKS WITH GRIP AND REINFORCEMENT 3 mm

The Resilient PRO Neoprene Socks are made from soft, 2mm double-lined neoprene. Designed with a unique cut to eliminate irritating seams on the sole and top of the foot, they provide superior comfort during aquatic and land activities. The glideskin neoprene around the ankle prevents slipping, enhancing fit and comfort. The toe and sole areas are reinforced with durable nylon, increasing the sock's lifespan. The sole features a rubberized grip, ensuring excellent traction at all times.

ANTI-SLIP GRIP SOLE

REINFORCED POINTE



SIZE	EU	THK	CODE		RRP €
XS	36-37	3 mm	XLX438301		29,99
S	38-39	3 mm	XLX438302		29,99
M	40-41	3 mm	XLX438303		29,99
L	42-43	3 mm	XLX438304		29,99
XL	44-45	3 mm	XLX438305		29,99
2XL	46-47	3 mm	XLX438306		29,99

RESILIENT

NEW 2025

THICKNESSES AVAILABLE: 3-5 MM | SOFT HIGHLY ELASTIC NEOPRENE

NEOPRENE SOCKS 3 mm, 5 mm

Made from ultra-stretch neoprene, the Resilient socks are available in two thickness variants: 3mm and 5mm, offering a range of options suitable for different diving conditions. The new design, ergonomic shape and construction provide an impeccable fit, minimizing water ingress and maximizing the snug feel. Thanks to the intelligent design and elasticity of the ultra-stretch neoprene, they can be put on easily and quickly, offering a fit that adapts to your body and needs.



SIZE	EU	THK	CODE		RRP €
XS	36-37	3 mm	XLX433400		19,99
S	38-39	3 mm	XLX433401		19,99
M	40-41	3 mm	XLX433402		19,99
L	42-43	3 mm	XLX433403		19,99
XL	44-45	3 mm	XLX433404		19,99
XS	36-37	5 mm	XLX433500		29,99
S	38-39	5 mm	XLX433501		29,99
M	40-41	5 mm	XLX433502		29,99
L	42-43	5 mm	XLX433503		29,99
XL	44-45	5 mm	XLX433504		29,99

AQUA GRIP NEW 2025

NEOPRENE SOCKS 3 mm

The AquaGrip Neoprene Socks are crafted from soft, stretchy double-lined neoprene. Designed for aquatic and surface activities, these short socks feature a non-slip grip on the entire sole. The innovative cut ensures no irritating seams on the sole or top of the foot, enhancing comfort. A convenient rear pull tab aids in easy wearing, perfect for all your water adventures.

THICKNESS 3MM | NON-SLIP SOLE

ANTI-SLIP GRIP SOLE



SIZE	EU	THK	CODE		RRP €
XS	36-37	3 mm	XLX439301		29.99
S	38-39	3 mm	XLX439302		29.99
M	40-41	3 mm	XLX439303		29.99
L	42-43	3 mm	XLX439304		29.99
XL	44-45	3 mm	XLX439305		29.99

FINS SOCKS

TEXTILE SOCKS

These fin-socks are designed for people who live in their fins and need that perfect snug fit of a full foot fin. But also for people who seldom use fins or have sensitive feet. These socks are the solution that will allow you wearing your fins for hours and more without chafing your feet.

ULTRA STRETCH TEXTILE MATERIALS



SIZE	EU	CODE		RRP €
S/M	36-41	USW030000K		17.99
L/XL	42-46	USW031000K		17.99

JUTLAND

NEOPRENE GLOVES 5MM

THICKNESS
5MM

ULTRA GRIP
SYSTEM

ERGONOMIC
DESIGN

Jutland gloves are the ideal accessory for diving practitioners. With a thickness of 5 mm, they offer optimal protection against external agents and abrasions.

Their ergonomic design with pre-shaped finger accommodation guarantees a comfortable and secure fit, as well as practicality and ease of use. The distinctive feature of the Jutland gloves is the ultra-grip system that extends over the entire surface area, allowing optimal grip.

Reliability, functionality, style, and comfort.

TECHNICAL FEATURES

- Total protection
- 5MM thickness
- Maximum grip
- Ergonomic finger design
- Underwater adaptability



PRODUCT	THK	SIZE	CODE		RRP €
JUTLAND GLOVES	5mm	S/2	LX480502		79.99
JUTLAND GLOVES	5mm	M/3	LX480503		79.99
JUTLAND GLOVES	5mm	L/4	LX480504		79.99
JUTLAND GLOVES	5mm	XL/5	LX480505		79.99
JUTLAND GLOVES	5mm	2XL/6	LX480506		79.99

CRUZ

NEOPRENE GLOVES 3MM

THICKNESS
3MM

ULTRA GRIP
SYSTEM

ERGONOMIC
DESIGN

Cruz diving gloves are the perfect companion for exploring the underwater world. At 3 mm thick, they offer optimal protection without sacrificing tactile sensitivity.

The ultra grip system on the palm ensures a secure and reliable grip on wet or slippery surfaces. The preformed finger accommodation offers a comfortable fit and facilitates movement.

Their practical design and comfortable fit combine functionality and comfort.

TECHNICAL FEATURES

- Secure, non-slip grip
- 3 mm thick
- Ergonomic fit
- Easy to put on, ready for action
- Versatile protection
- Agile movements



PRODUCT	THK	SIZE	CODE		RRP €
CRUZ GLOVES	3mm	S/2	LX481302		49.99
CRUZ GLOVES	3mm	M/3	LX481303		49.99
CRUZ GLOVES	3mm	L/4	LX481304		49.99
CRUZ GLOVES	3mm	XL/5	LX481305		49.99
CRUZ GLOVES	3mm	2XL/6	LX481306		49.99

RESILIENT NEW 2025

NEOPRENE GLOVES 2MM, 3MM

THICKNESS
2MM AND 3MM

ULTRA GRIP
SYSTEM

ERGONOMIC
DESIGN

Available in 2mm and 3mm thicknesses, these gloves offer reliable protection without compromising tactile sensitivity, allowing a direct connection to the underwater environment. The ultra-grip system on the palm ensures a secure and reliable grip on wet or slippery surfaces, providing peace of mind and stability while diving. The practical design of the Resilient gloves combines with a comfortable fit, combining functionality and comfort to meet the needs of the most demanding divers. Whether you are exploring the seabed or engaging in aquatic activities, Resilient gloves are designed for reliable performance and lasting comfort.

TECHNICAL FEATURES

- Total protection
- 5MM thickness
- Maximum grip
- Ergonomic finger design
- Underwater adaptability



PRODUCT	CODE	THK	SIZE		RRP €
RESILIENT GLOVES	XLX479202	2mm	S		24,99
RESILIENT GLOVES	XLX479203	2mm	M		24,99
RESILIENT GLOVES	XLX479204	2mm	L		24,99
RESILIENT GLOVES	XLX479205	2mm	XL		24,99
RESILIENT GLOVES	XLX479206	2mm	2XL		24,99
RESILIENT GLOVES	XLX479302	3mm	S		29,99
RESILIENT GLOVES	XLX479303	3mm	M		29,99
RESILIENT GLOVES	XLX479304	3mm	L		29,99
RESILIENT GLOVES	XLX479305	3mm	XL		29,99
RESILIENT GLOVES	XLX479306	3mm	2XL		29,99

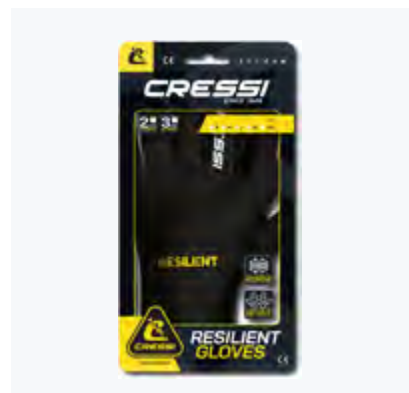

HIGH STRETCH

NEOPRENE GLOVES 2.5 mm, 3.5 mm & 5 mm

THICKNESSES AVAILABLE:
2.5 mm, 3.5 mm, 5 mm

5-finger gloves made from single-lined soft, high-stretch neoprene. The inside is covered in Metallite to make them easy to put on. The preformed shape favours the natural position of the hand, with semi-bent fingers. The entire surface is covered with a non-slip finish for a sure grip in all situations.



SIZE	2.5 mm		RRP €
S	LX475701		37,99
M	LX475702		37,99
L	LX475703		37,99
XL	LX475704		37,99

SIZE	3.5 mm		RRP €
S	LX475801		39,99
M	LX475802		39,99
L	LX475803		39,99
XL	LX475804		39,99

SIZE	5 mm		RRP €
S	LX475901		44,99
M	LX475902		44,99
L	LX475903		44,99
XL	LX475904		44,99



Photo by: Kayleigh Burns & Cam Grant

DEFENDER

HPPE GLOVES 2 mm

These gloves are made from HPPE, High Performance Poly Ethylene, a material that provides the hands with superior protection from cuts and abrasions. The finger reinforcement is made from rubber coating, works as a non-slip finish and facilitates a sure grip in all situations. Flexibility, lightweight and comfort are optimal.

ANTI-ABRASION MATERIAL HPPE
 FIBERS DYNEEMA
 RUBBER-COATED FINGERS
 THICKNESS 2 MM



SIZE	CODE		RRP €
S	LX478601		19,99
M	LX478602		19,99
L	LX478603		19,99
XL	LX478604		19,99

TROPICAL

LIGHT GLOVES 2 mm

Five fingered gloves 2 mm thick neoprene, made from two different soft and light materials. The palm and finger area uses a light grey napa that becomes extraordinarily soft upon contact with the water. However, the upper part of the glove and the wrist area are made from very thin, supple neoprene. A large area that corresponds to the upper side of the wrist allows for instant adjustment, both before and during the dive. These are particularly suitable gloves when you need the very best touch sensitivity in the fingers. The palm also offers good resistance to abrasions.

THICKNESS 2 MM



SIZE	CODE		RRP €
S	LX475301		25,99
M	LX475302		25,99
L	LX475303		25,99
XL	LX475304		25,99
2XL	LX475305		25,99

Photo by: Eleonora Bergamasco

FOR YOUR DOG'S SAKE

Cressi Dog is a new line dedicated to dogs by Cressi and designed to promote the well-being and security of the animal in its relationship with water, so that it can live this experience in total harmony and serenity.

CRESSI DOG

Official Website

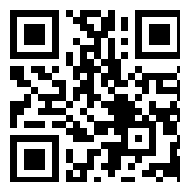

www.cressidog.com

Official Blog

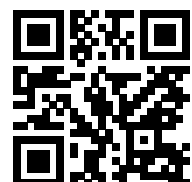

www.blogcressidog.it

DLJ DOG LIFE JACKET

DON'T SINK, FLOAT AND SWIM

The Dog Life Jacket is a garment of Duratex 1000 denier black fabric (like Cordura) and Polyester 500 denier (goose-beak yellow) specifically designed to keep the animal on the surface or to facilitate it to swim. It is the necessary equipment for rescue dogs in water and is very useful for rehabilitation. It has a practical ring for the leash and a comfortable handle (three in sizes L-XL) to facilitate the recovery of the dog when you are on the boat.

The jacket has been exactly achieved to keep the dog in the correct swimming position and to facilitate its movements, both when it is submerged and on the surface. The Life Jacket is ergonomic, comfortable and easy to wear. The 7 sizes range is from Micro 2XS to XL. This product has also been designed to be used over the Cressi Dog Wetsuit, which further increases the dog's protection against the cold.



TECHNICAL FEATURES

- Padding made of material with intrinsic buoyancy
- Duratex 1000 denier fabric and polyester 500 denier
- Double strip of high-visibility silver reflective material EN471 and inserts of the same material
- Embroidered logos and rubberized logo
- Two ventral padded bands for greater dog comfort

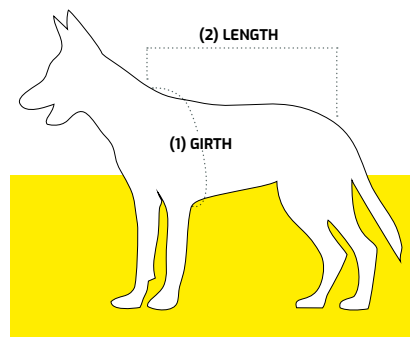

SIZE	WEIGHT - KG	(1) GIRTH - CM	(2) LENGTH - CM
M2XS	-	26 - 42	22 - 30
MXS	-	30 - 50	26 - 35
XS	7 - 11	48 - 81	25 - 33
S	9 - 20	53 - 89	33 - 41
M	18 - 27	64 - 99	38 - 50
L	27 - 41	69 - 111	43 - 61
XL	> 41	76 - 122	51 - 66

SIZE	WEIGHT - LB	(1) GIRTH - INCH	(2) LENGTH - INCH
M2XS	-	10 - 16.5	8.5 - 12
MXS	-	12 - 19.5	10 - 13.5
XS	15 - 25	19 - 32	10 - 13
S	20 - 45	21 - 35	13 - 16
M	40 - 60	25 - 39	15 - 20
L	60 - 90	27 - 44	17 - 24
XL	> 90	30 - 48	20 - 26

PRODUCT	SIZE	CODE	RRP €
DOG LIFE JACKET	M2XS	LB500002	79,99
DOG LIFE JACKET	MXS	LB500003	79,99
DOG LIFE JACKET	XS	LB500004	94,99
DOG LIFE JACKET	S	LB500005	94,99
DOG LIFE JACKET	M	LB500006	109,99
DOG LIFE JACKET	L	LB500008	109,99
DOG LIFE JACKET	XL	LB500009	109,99

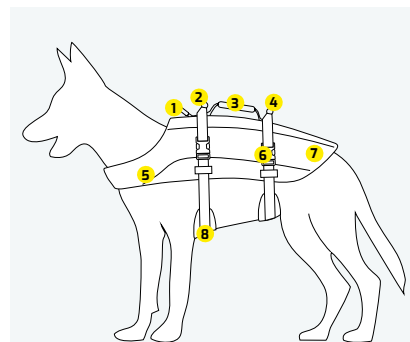

1. D-Ring anchor point, to attach the leash and/or an eventual signalling night light
2. Additional handle (L-XL)
3. Comfortable handle to facilitate recovery of the dog from the boat or the swimming pool
4. Additional handle (L-XL)
5. High visibility profiles
6. High strength buckles
7. Anatomic Design
8. Padded band

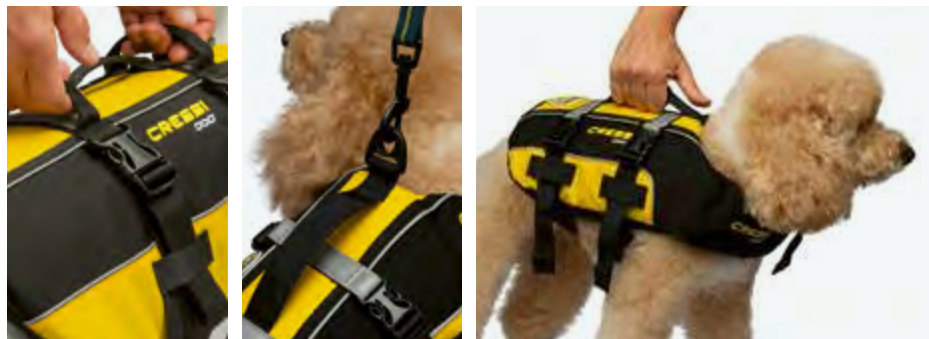

DWS DOG WETSUIT

KEEPS YOUR DOG WARM AND SAFE

The Dog Wetsuit is a 3 mm thick neoprene bodysuit that isolates the body of the animal and protects it from the cold, thanks to the air cells of its structure which, at the same time, facilitate the buoyancy. The use of the wetsuit, due to its thermal characteristics, can avoid the onset of swimmer's tail syndrome. The soft material that wraps the dog gives it a reassuring effect and promotes calm and self-control.

The Dog Wetsuit presents a cut that follows canine anatomy and allows free movements avoiding any constriction. The garment has a comfortable full-opening zipper on the back, which facilitates dressing. The 11 sizes range is from Micro XS to XXL. This product has also been designed to be used under the Cressi Dog Life Jacket, which further increases the dog's buoyancy.

HIGH BUOYANCY | COMFORTABLE | DURABLE

TECHNICAL FEATURES

- Made of 100% neoprene
- Available in 11 different sizes
- Bright color for more visibility
- Rubberized logo
- Back closure zip

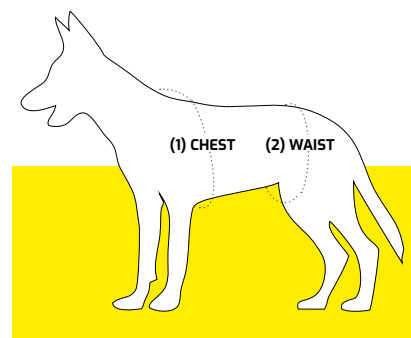

SIZE	(1) CHEST	(2) WAIST
MicroXS	27-32 cm (10.5-13 inch)	23-26 cm (9-10.5 inch)
3XS	34-37 cm (13.5-15 inch)	25-28 cm (10-11 inch)
2XS	40-43.5 cm (16-17 inch)	30-33.5 cm (11.8-13 inch)
XS	44-47 cm (17-19 inch)	34-37.5 cm (13.4-14.8 inch)
S	47-50.5 cm (19-20 inch)	37-40.5 cm (14.5-16 inch)
S/M	55-58 cm (22-23 inch)	42-45 cm (16.5-17.7 inch)
M	61-64 cm (24-25 inch)	47-50 cm (18.5-19.7 inch)
ML	66-69 cm (26-27 inch)	53-55 cm (20.8-21.7 inch)
L	75-78 cm (29.5-31 inch)	59-62 cm (23-24 inch)
XL	84-87 cm (33-34 inch)	66-69 cm (26-27 inch)
2XL	89-92 cm (35-36 inch)	71-74 cm (28-29 inch)

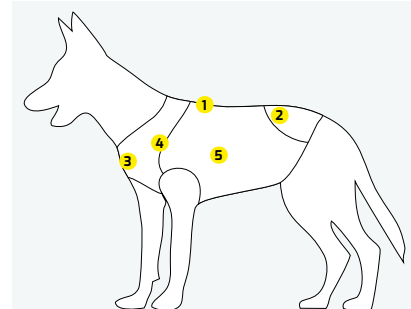

1. Zippered opening
2. Anatomic Design
3. Freedom of movement
4. Thermal protection
5. 100% neoprene vest



PRODUCT	SIZE	CODE	RRP €
DOG WETSUIT 3 mm	MICRO XS	LB100001	79,99
DOG WETSUIT 3 mm	3XS	LB100002	79,99
DOG WETSUIT 3 mm	2XS	LB100003	79,99
DOG WETSUIT 3 mm	XS	LB100004	79,99
DOG WETSUIT 3 mm	S	LB100005	79,99
DOG WETSUIT 3 mm	SM	LB100006	79,99
DOG WETSUIT 3 mm	M	LB100007	79,99
DOG WETSUIT 3 mm	ML	LB100008	79,99
DOG WETSUIT 3 mm	L	LB100009	79,99
DOG WETSUIT 3 mm	XL	LB100010	79,99
DOG WETSUIT 3 mm	2XL	LB100011	79,99



Photo by: Eleonora Bergamasco





Photo by: Ourdays



QUICK DRY FABRIC

50+ UV PROTECTION

HIGHLY STRETCHABLE

SHORT & LONG SLEEVE OPTIONS AVAILABLE

DIVE CENTER

LONG SLEEVES RASHGUARD

Ideal for diving, snorkeling, surfing and other water sports, this rash guard helps protect the torso from equipment abrasion and delivers SPF 40 protection from harmful UV rays. Available in a full range of

men's, women's, the quality 190 gms/m² material is high-stretch for easier swimming and is styled and cut for a flattering fit.

TECHNICAL FEATURES

- This protective t-shirt is made from special, stretchy material
- It offers excellent protection from the sun, wind and low temperatures either in the water or when dry
- Flat-lock stitching for comfort and durability
- Ideal for diving, snorkeling, surfing and other water sports,
- White pad to write name or number



MAN	(1) CHEST	(2) LENGTH
2XS	36 cm (14 in)	54 cm (21 in)
XS	40 cm (16 in)	57,5 cm (23 in)
S	40 cm (16 in)	59 cm (23 in)
M	45,5 cm (18 in)	62 cm (24 in)
L	48,8 cm (19 in)	66 cm (26 in)
XL	52,5 cm (21 in)	67,5 cm (27 in)
2XL	55,5 cm (22 in)	70,5 cm (28 in)
3XL	58 cm (23 in)	73,5 cm (29 in)
4XL	60,5 cm (24 in)	76 cm (30 in)



LADY	(1) CHEST	(2) LENGTH
2XS	35 cm (14 in)	50 cm (20 in)
XS	38 cm (15 in)	54 cm (21 in)
S	40,5 cm (16 in)	56,5 cm (22 in)
M	42 cm (17 in)	56,5 cm (22 in)
L	43,5 cm (17 in)	59 cm (23 in)
XL	44 cm (17 in)	61 cm (24 in)
2XL	45,7 cm (18 in)	63,5 cm (25 in)

PRODUCT	SIZE	CODE	RRP €
DIVE CENTER RASH GUARD LONG/SL BLACK	MAN S/2 (48)	JLW478502	49,99
DIVE CENTER RASH GUARD LONG/SL BLACK	MAN M/3 (50)	JLW478503	49,99
DIVE CENTER RASH GUARD LONG/SL BLACK	MAN L/4 (52)	JLW478504	49,99
DIVE CENTER RASH GUARD LONG/SL BLACK	MAN XL/5 (54)	JLW478505	49,99
DIVE CENTER RASH GUARD LONG/SL BLACK	MAN 2XL/6 (56)	JLW478506	49,99
DIVE CENTER RASH GUARD LONG/SL BLACK	MAN 3XL/7 (58)	JLW478507	49,99
DIVE CENTER RASH GUARD LONG/SL BLACK	LADY XS/1 (36)	JLW478601	49,99
DIVE CENTER RASH GUARD LONG/SL BLACK	LADY S/2 (38)	JLW478602	49,99
DIVE CENTER RASH GUARD LONG/SL BLACK	LADY M/3 (40)	JLW478603	49,99
DIVE CENTER RASH GUARD LONG/SL BLACK	LADY L/4 (42)	JLW478604	49,99
DIVE CENTER RASH GUARD LONG/SL BLACK	LADY XL/5 (44)	JLW478605	49,99



DIVE CENTER

SHORT SLEEVES RASHGUARD

Ideal for diving, snorkeling, surfing and other water sports, this rash guard helps protect the torso from equipment abrasion and delivers 50+ protection from harmful UV rays. Available in a full range of

men's, women's, the quality 190 gms/m2 material is high-stretch for easier swimming and is styled and cut for a flattering fit.

TECHNICAL FEATURES

- This protective t-shirt is made from special, stretchy material
- It offers excellent protection from the sun, wind and low temperatures either in the water or when dry
- Flat-lock stitching for comfort and durability
- Ideal for diving, snorkeling, surfing and other water sports.
- White pad to write name or number



WRITABLE WHITE PAD



MAN	(1) CHEST	(2) LENGTH
2XS	36 cm (14 in)	54 cm (21 in)
XS	40 cm (16 in)	57.5 cm (23 in)
S	40 cm (16 in)	59 cm (23 in)
M	45.5 cm (18 in)	62 cm (24 in)
L	48.8 cm (19 in)	66 cm (26 in)
XL	52.5 cm (21 in)	67.5 cm (27 in)
2XL	55.5 cm (22 in)	70.5 cm (28 in)
3XL	58 cm (23 in)	73.5 cm (29 in)
4XL	60.5 cm (24 in)	76 cm (30 in)

LADY	(1) CHEST	(2) LENGTH
2XS	35 cm (14 in)	50 cm (20 in)
XS	38 cm (15 in)	54 cm (21 in)
S	40.5 cm (16 in)	56.5 cm (22 in)
M	42 cm (17 in)	56.5 cm (22 in)
L	43.5 cm (17 in)	59 cm (23 in)
XL	44 cm (17 in)	61 cm (24 in)
2XL	45.7 cm (18 in)	63.5 cm (25 in)

PRODUCT	SIZE	CODE	RRP €
DIVE CENTER RASH GUARD SHORT/SL BLACK	MAN 5/2 (48)	JLW478302	39,99
DIVE CENTER RASH GUARD SHORT/SL BLACK	MAN M/3 (50)	JLW478303	39,99
DIVE CENTER RASH GUARD SHORT/SL BLACK	MAN L/4 (52)	JLW478304	39,99
DIVE CENTER RASH GUARD SHORT/SL BLACK	MAN XL/5 (54)	JLW478305	39,99
DIVE CENTER RASH GUARD SHORT/SL BLACK	MAN 2XL/6 (56)	JLW478306	39,99
DIVE CENTER RASH GUARD SHORT/SL BLACK	MAN 3XL/7 (58)	JLW478307	39,99
DIVE CENTER RASH GUARD SHORT/SL BLACK	LADY XS/1 (36)	JLW478401	39,99
DIVE CENTER RASH GUARD SHORT/SL BLACK	LADY S/2(38)	JLW478402	39,99
DIVE CENTER RASH GUARD SHORT/SL BLACK	LADY M/3 (40)	JLW478403	39,99
DIVE CENTER RASH GUARD SHORT/SL BLACK	LADY L/4 (42)	JLW478404	39,99
DIVE CENTER RASH GUARD SHORT/SL BLACK	LADY XL/5 (44)	JLW478405	39,99



/ RASHGUARD



Photo by: Jil Van Dijk

SHIELD

RASHGUARD T-SHIRT MAN & LADY

Cressi Shield Rash Guard are designed for all water sports. The composition of the fabric enables the clothes to dry very quickly and provide protection from harmful UV rays.

The elasticity of these rash guards and the flat seams offer complete comfort during movement, while maintaining excellent resistance to any abrasions caused by rubbing in the water.

- QUICK DRY FABRIC
- 50 + UV PROTECTION
- HIGHLY STRETCHABLE
- FLAT-LOCK STITCHING
- SLIM-FIT

FEATURES & SIZE CHARTS

Sleeve	Short sleeve
Collar	Mid-collar
Composition	92% Nylon - 8% Spandex
UV Protection	50 +
Box dimensions	25x5x10 cm



MAN	(1) CHEST	(2) LENGTH
2XS	36 cm (14 inch)	54 cm (21 inch)
XS	40 cm (16 inch)	57,5 cm (23 inch)
S	40 cm (16 inch)	59 cm (23 inch)
M	45,5 cm (18 inch)	62 cm (24 inch)
L	48,8 cm (19 inch)	66 cm (26 inch)
XL	52,5 cm (21 inch)	67,5 cm (27 inch)
2XL	55,5 cm (22 inch)	70,5 cm (28 inch)
3XL	58 cm (23 inch)	73,5 cm (29 inch)

LADY	(1) CHEST	(2) LENGTH
2XS	35 cm (14 inch)	50 cm (20 inch)
XS	38 cm (15 inch)	54 cm (21 inch)
S	40,5 cm (16 inch)	56,5 cm (22 inch)
M	42 cm (17 inch)	56,5 cm (22 inch)
L	43,5 cm (17 inch)	59 cm (23 inch)
XL	44 cm (17 inch)	61 cm (24 inch)
2XL	45,7 cm (18 inch)	63,5 cm (25 inch)



SIZE	MAN WHITE BLUE	MAN BLUE ROYAL	MAN BLACK GREY	LADY WHITE AQUAM.	LADY AQUAM. PINK	LADY BLACK YELLOW	RRP €
2XS/0	-	-	-	NH000010	NH000120	NH000150	49,99
XS/1	-	-	-	NH000011	NH000121	NH000151	49,99
S/2	NH000002	NH000022	NH000052	NH000012	NH000122	NH000152	49,99
M/3	NH000003	NH000023	NH000053	NH000013	NH000123	NH000153	49,99
L/4	NH000004	NH000024	NH000054	NH000014	NH000124	NH000154	49,99
XL/5	NH000005	NH000025	NH000055	NH000015	NH000125	NH000155	49,99
2XL/6	NH000006	NH000026	NH000056	NH000016	NH000126	NH000156	49,99
3XL/7	NH000007	NH000027	NH000057	-	-	-	49,99

RASHGUARD

SHORT SLEEVES MAN & LADY

Ideal For Diving, Snorkeling, Surfing, and Other Water Sports, This Short-Sleeve Rash Guard Helps Protect The Torso From Equipment Abrasion And Delivers Spf 40 Protection From Harmful Uv Rays.

Available In A Full Range Of Men'S, Women'S, and Children'S Sizes, The Quality 190 Gms/M2 Material Is High-Stretch For Easier Swimming And Is Styled And Cut For A Flattering Fit.

COMPOSITION NYLON 92% + SPANDEX 8%
 PROVIDES PROTECTION FROM SUN'S HARMFUL UVA AND UVB RAYS

HIGH-STRETCH MATERIAL FOR EXCELLENT FIT
 FLAT-LOCK STITCHING FOR COMFORT AND DURABILITY

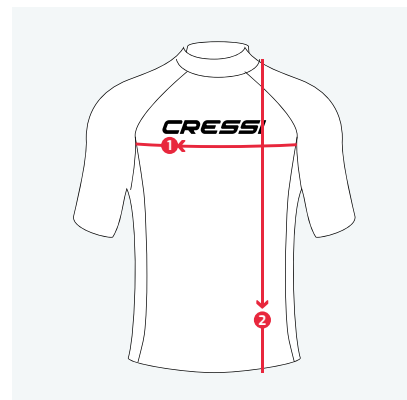

MAN	(1) CHEST	(2) LENGTH
5/2 (48)	40 cm (16 inch)	59 cm (23 inch)
M/3 (50)	45.5 cm (18 inch)	62 cm (24 inch)
L/4 (52)	48.8 cm (19 inch)	66 cm (26 inch)
XL/5 (54)	52.5 cm (21 inch)	67.5 cm (27 inch)
XXL/6 (56)	55.5 cm (22 inch)	70.5 cm (28 inch)
3XL/7 (58)	58 cm (23 inch)	73.5 cm (29 inch)

LADY	(1) CHEST	(2) LENGTH
XS/1 (36)	38 cm (15 inch)	54 cm (21 inch)
S/2 (38)	40.5 cm (16 inch)	56.5 cm (22 inch)
M/3 (40)	42 cm (17 inch)	56.5 cm (22 inch)
L/4 (42)	43.5 cm (17 inch)	59 cm (23 inch)
XL/5 (44)	44 cm (17 inch)	61 cm (24 inch)

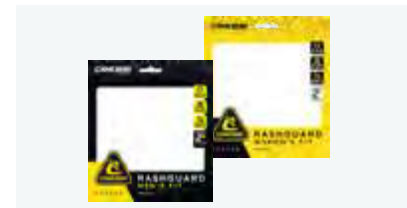

MAN	BLACK	BLUE	DARK BLUE	BLACK ORANGE	CAMOU.		RRP €
5/2 (48)	LW476702	LW476602	XLW476722	XLW478402	XLW478702		39.99
M/3 (50)	LW476703	LW476603	XLW476723	XLW478403	XLW478703		39.99
L/4 (52)	LW476704	LW476604	XLW476724	XLW478404	XLW478704		39.99
XL/5 (54)	LW476705	LW476605	XLW476722	XLW476725	XLW478705		39.99
XXL/6 (56)	LW476706	LW476606	XLW476723	XLW476726	XLW478706		39.99
3XL/7 (58)	LW476707	LW476607	XLW476724	XLW476727	XLW478707		39.99
LADY	WHITE LILAC	BLACK WHITE	PINK	AQUAMARINE	BLACK PINK		RRP €
XS/1 (36)	LW476801	LW476851	XLW474001	XLW474101	XLW474301		39.99
S/2 (38)	LW476802	LW476852	XLW474002	XLW474102	XLW474302		39.99
M/3 (40)	LW476803	LW476853	XLW474003	XLW474103	XLW474303		39.99
L/5 (42)	LW476804	LW476854	XLW474004	XLW474104	XLW474304		39.99
XL/5 (44)	LW476805	LW476855	XLW474005	XLW474105	XLW474305		39.99



RASHGUARD

LONG SLEEVES MAN & LADY

Long-sleeve protective rash guard made with high quality materials. Soft and stretchy, it offers a great fit that adheres to the body. Ideal for diving, snorkeling, surfing, and other water sports.

It protects against chafing caused by sports equipment and provides 50+ sun protection against harmful UV rays.

COMPOSITION NYLON 92% + SPANDEX 8%

HIGH-STRETCH MATERIAL FOR EXCELLENT FIT

PROVIDES PROTECTION FROM SUN'S HARMFUL UVA AND UVB RAYS

FLAT-LOCK STITCHING FOR COMFORT AND DURABILITY

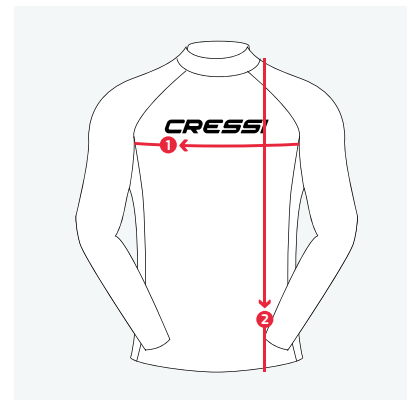

MAN	(1) CHEST	(2) LENGTH
S/2 (48)	40 cm (16 inch)	59 cm (23 inch)
M/3 (50)	45.5 cm (18 inch)	62 cm (24 inch)
L/4 (52)	48.8 cm (19 inch)	66 cm (26 inch)
XL/5 (54)	52.5 cm (21 inch)	67.5 cm (27 inch)
XXL/6 (56)	55.5 cm (22 inch)	70.5 cm (28 inch)
3XL/7 (58)	58 cm (23 inch)	73.5 cm (29 inch)

LADY	(1) CHEST	(2) LENGTH
XS/1 (36)	38 cm (15 inch)	54 cm (21 inch)
S/2 (38)	40.5 cm (16 inch)	56.5 cm (22 inch)
M/3 (40)	42 cm (17 inch)	56.5 cm (22 inch)
L/4 (42)	43.5 cm (17 inch)	59 cm (23 inch)
XL/5 (44)	44 cm (17 inch)	61 cm (24 inch)



BLACK/WHITE

BLUE

BLACK/PINK

BLUE

MAN	BLACK/WHITE	BLUE	RRP €
S/2 (48)	XLW477152	LW477102	44,99
M/3 (50)	XLW477153	LW477103	44,99
L/4 (52)	XLW477154	LW477104	44,99
XL/5 (54)	XLW477155	LW477105	44,99
XXL/6 (56)	XLW477156	LW477106	44,99
3XL/7 (58)	XLW477157	LW477107	44,99
LADY	BLACK/PINK	BLUE	RRP €
XS/1 (36)	XLW474401	LW477201	44,99
S/2 (38)	XLW474402	LW477202	44,99
M/3 (40)	XLW474403	LW477203	44,99
L/4 (42)	XLW474404	LW477204	44,99
XL/5 (44)	XLW474405	LW477205	44,99



ARMOR

RASHGUARD SLIM-FIT SHORTS

Cressi Armor are designed for all water sports. The composition of the fabric enables the clothes to dry very quickly and provide protection from harmful UV rays.

The elasticity of these rash guards and the flat seams offer complete comfort during movement, while maintaining excellent resistance to any abrasions caused by rubbing in the water.

- QUICK DRY FABRIC
- 50 + UV PROTECTION
- HIGHLY STRETCHABLE
- FLAT-LOCK STITCHING
- SLIM-FIT

FEATURES & SIZE CHARTS

Composition 92% Nylon - 8% Spandex

UV Protection 50 +

Box dimensions 25x5x10 cm



MAN	(1) WAIST	(2) LENGTH
XS	65.2 cm (25 inch)	51.7 cm (20 inch)
S	66.9 cm (26 inch)	52.2 cm (20 inch)
M	68.6 cm (27 inch)	52.9 cm (20 inch)
L	71.6 cm (28 inch)	54.2 cm (21 inch)
XL	74.5 cm (29 inch)	55.9 cm (22 inch)
2XL	77.4 cm (30 inch)	57.6 cm (22 inch)
3XL	80.5 cm (31 inch)	59 cm (23 inch)
4XL	83.5 cm (32 inch)	61 cm (24 inch)

LADY	(1) WAIST	(2) LENGTH
XS	59.7 cm (23 inch)	43.6 cm (17 inch)
S	62.7 cm (24 inch)	45.6 cm (18 inch)
M	65.7 cm (25 inch)	47 cm (18 inch)
L	69.7 cm (27 inch)	49.3 cm (19 inch)
XL	73.7 cm (29 inch)	51.6 cm (20 inch)
2XL	77.7 cm (30 inch)	53.9 cm (21 inch)



PRODUCT	CODE	RRP €
ARMOR RASH GUARD SHORTS MAN BLACK XS/1	NH010001	49,99
ARMOR RASH GUARD SHORTS MAN BLACK S/2	NH010002	49,99
ARMOR RASH GUARD SHORTS MAN BLACK M/3	NH010003	49,99
ARMOR RASH GUARD SHORTS MAN BLACK L/4	NH010004	49,99
ARMOR RASH GUARD SHORTS MAN BLACK XL/5	NH010005	49,99
ARMOR RASH GUARD SHORTS MAN BLACK 2XL/6	NH010006	49,99
ARMOR RASH GUARD SHORTS MAN BLACK 3XL/7	NH010007	49,99
ARMOR RASH GUARD SHORTS MAN BLACK 4XL/8	NH010008	49,99

PRODUCT	CODE	RRP €
ARMOR LADY RASH GUARD SHORTS BLACK XS/1	NH010011	49,99
ARMOR LADY RASH GUARD SHORTS BLACK S/2	NH010012	49,99
ARMOR LADY RASH GUARD SHORTS BLACK M/3	NH010013	49,99
ARMOR LADY RASH GUARD SHORTS BLACK L/4	NH010014	49,99
ARMOR LADY RASH GUARD SHORTS BLACK XL/5	NH010015	49,99
ARMOR LADY RASH GUARD SHORTS BLACK 2XL/6	NH010016	49,99



RASHGUARD JUNIOR

SHORT SLEEVES

Short sleeve shirt for children for sports, developed in Italy. Suitable for water sports, swimming or snorkelling, surfing, sailing, etc and higher comfort and UV protection.



BLUE

PINK



USED FOR MANY OUTDOOR ACTIVITIES

FLATLOCK STITCHING FOR COMFORT AND DURABILITY

COMPOSITION 100% ELASTENE

AVA AND UVB RAYS PROTECTION

TECHNICAL FEATURES

- Kid safe but is not a life saving device. Should always be used under adult supervision.
- With back flotation for survival breathing training

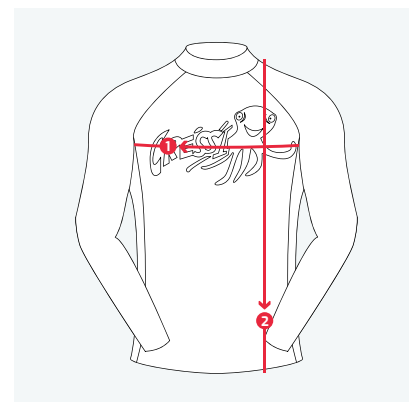
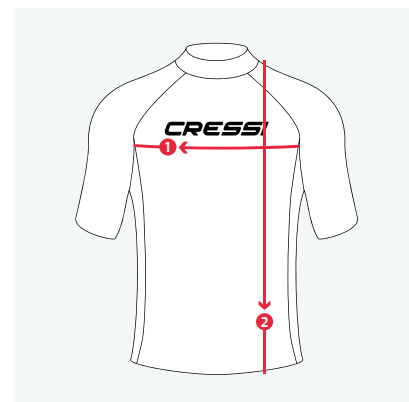

AGE	BLUE	PINK	RRP €
4-5	LW476901	LW477001	29.99
6-7	LW476902	LW477002	29.99
8-9	LW476903	LW477003	29.99
10-11	LW476904	LW477004	29.99
12-13	LW476905	LW477005	29.99

RASHGUARD JUNIOR L/S

LONG SLEEVES



AGE	BLUE OCTOPUS	RRP €
4-5	LW477501	39.99
6-7	LW477502	39.99
8-9	LW477503	39.99
10-11	LW477504	39.99
12-13	LW477505	39.99

JR AGE	(1) CHEST	(2) LENGTH
4-5	33 cm (13 inch)	36 cm (14 inch)
6-7	34 cm (13 inch)	40 cm (16 inch)
8-9	36 cm (14 inch)	43 cm (17 inch)
10-11	38 cm (15 inch)	47 cm (19 inch)
12-13	38.5 cm (15 inch)	49 cm (19 inch)





Photo by: Theo Knevel



Photo by: Voyages of Agape



Photo by: Voyages of Agape



ORIGIN

**HISTORIC
LEGACY
WITH MODERN
TECHNICAL
UPGRADE** <<

CARLOS GODOY
Technical Manager Soft Goods



NEW 2025

WHY BUY IT?

Origin HD and LD fins are designed to meet the needs of divers who use fins intensively, offering precision, strength and negative or positive buoyancy, respectively.

WHAT MAKES IT DIFFERENT?

Origin fins carry on the historical legacy of the **RONDINE US COMMANDO** fins with a modern technical update. Their construction characteristics make them perfect for:

- **HD:** use with a drysuit and medium-heavy equipment.
- **LD:** perfect for wetsuits and medium-light equipment.

WHERE IS THE INNOVATION?

Origin fins are distinguished by their excellent maneuverability, regardless of finning style. They are equipped with self-adjusting spring-loaded stainless steel straps with a wide grip, offering unprecedented customization. Construction from a single, highly abrasion-resistant material guarantees exceptional strength and durability.



ORIGIN HD



NEW 2025

SOFT AND STABLE

NEGATIVE ASSET

STAINLESS STEEL BUNGEE EXTENDER

HIGH DENSITY FIN

In 1950, long before technical diving was a concept, Cressi revolutionized the scuba diving world with the introduction of the vented RONDINE COMMANDO fins. These fins were originally designed for the U.S. Military Underwater Demolition Team (UDT) and saw extensive use in the 1960s. Today, the ORIGIN fins carry forward this historic legacy with a modern technical upgrade.

The heavy-duty requirements of technical diving align perfectly with these durable, abrasion-resistant fins made from a single material. Staying true to the original designs and patents, they offer either a positive or negative rubber versions. The ORIGIN HD is a high density material which is slightly negative, perfect for the use with drysuits and mid- to heavy gear.

TECHNICAL FEATURES

- Ultra compact and robust for the harshest environments
- Ergonomic foot pocket with spring-loaded straps for ease of use with cold hands or thick gloves
- The vented blades are short and wide, providing a very strong forward thrust
- Great for flutter kicks, frog kicks, helicopter turns and overall maneuverability
- Two attachment points when accessing the dive site or vertical storage
- Self-adjusting spring straps as standard
- The angled buckle keeps the spring straps in an optimal position over the heel cap
- The simple pin design allows the straps to be easily replaced if necessary



PRODUCT	SIZE	CODE	*CASE PACK		RRP €
ORIGIN FINS BLACK	S/M	CA250503	-		159,99
ORIGIN FINS BLACK	M/L	CA250504	-		159,99
ORIGIN FINS BLACK	L/XL	CA250505	-		159,99



Photo by: Theo Knevel

ORIGIN LD



SPECIALIZED
Retailer-Product

NEW 2025

SOFT AND LIGHT | HIGH BUOYANCY | POSITIVE ASSET | STAINLESS STEEL BUNGEE EXTENDER

LOW DENSITY FIN

In 1950, long before technical diving was a concept, Cressi revolutionised the world of scuba diving with the introduction of the RONDINE COMMANDO ventilated fins. These fins were originally designed for the US Army Underwater Demolition Team (UDT) and were widely used in the 1960s. Today, ORIGIN fins continue this historical legacy with modern technical improvements. The high demands of technical diving are perfectly matched by these durable, abrasion-resistant fins made

from a single material. Remaining authentic to the original designs and patents, they offer both positive and negative rubber versions. ORIGIN LD is a low-density material that is slightly buoyant, perfect for wet suits and medium to lightweight equipment.

TECHNICAL FEATURES

- Ultra-compact and robust for the toughest environments
- Ergonomic foot pocket with spring-loaded straps for ease of use with cold hands or thick gloves.
- The ventilated fins are short and wide, giving a very strong forward thrust.
- Ideal for webbing, frog kicks, helicopter turns and general manoeuvrability.
- Two attachment points for access to the dive site or vertical storage
- Self-adjusting spring straps as standard
- The angled buckle holds the spring straps in the optimum position on the heel piece.
- Simple pin design makes it easy to replace straps if necessary.



BLACK AZURE BLUE



WHITE YELLOW

SIZE	BLACK	BLUE	WHITE	YELLOW	AZURE	*CASE PACK		RRP €
S/M	CA251503	CA251203	CA251303	CA251103	CA251222	-		149,99
M/L	CA251504	CA251204	CA251304	CA251104	CA251223	-		149,99
L/XL	CA251505	CA251205	-	CA251105	CA251225	-		149,99

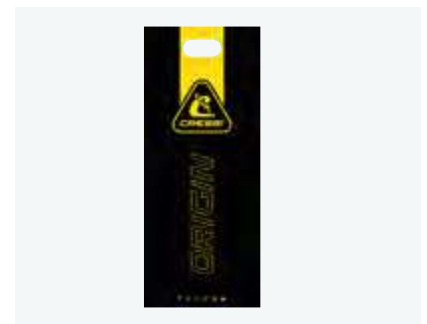

THOR EBS SPECIALIZED

FLOW CONVECTION EFFECT

SPECIAL ARCHED PROFILE

ELASTIC BUNGEE SYSTEM SCUBA FINS

Brand new design for this extremely effective and yet very easy to use fin. The special arched profile of the fins combined with the two central ribs promote a significant flow convection effect, known as "spoon effect", which stabilises and boosts propulsion. Two lateral holes discharge the

negative forces typically associated with this area and at the same time make for enhanced stability. The blades are moulded from two different materials for improved reactivity. These fins are perfect for scuba diving, whether you are an experienced diver or a novice.

TECHNICAL FEATURES



Cressi has developed this special strap to meet the needs of the most demanding divers, who need a comfortable fastening for their foot but one that is still practical and manageable. Its special amply sized slot makes it very easy to put on, even when wearing thick gloves or three-fingered gloves for winter water.

The wrapping section is highly flexible, making adjustments unnecessary, and as a result it's much easier to get all your equipment right in the first few meters of your descent and the fin stays in place against your foot despite the increase in hydrostatic pressure.



FINS WEARABILITY:



BLACK/SILVER

YELLOW

BLUE



PINK

RED

PRODUCT	SIZE	EU	CODE	*CASE PACK	RRP €
THOR EBS BLACK/GREY	X/S	36/38	BE155036	3	119,99
THOR EBS BLACK/GREY	S/M	39/41	BE155039	3	119,99
THOR EBS BLACK/GREY	L	42/44	BE155042	3	119,99
THOR EBS BLACK/GREY	XL	45/49	BE155045	3	119,99
THOR EBS YELLOW	X/S	36/38	BE151036	3	119,99
THOR EBS YELLOW	S/M	39/41	BE151039	3	119,99
THOR EBS YELLOW	L	42/44	BE151042	3	119,99
THOR EBS YELLOW	XL	45/49	BE151045	3	119,99
THOR EBS BLUE	X/S	36/38	BE152036	3	119,99
THOR EBS BLUE	S/M	39/41	BE152039	3	119,99
THOR EBS BLUE	L	42/44	BE152042	3	119,99
THOR EBS BLUE	XL	45/49	BE152045	3	119,99
THOR EBS PINK	X/S	36/38	BE154036	3	119,99
THOR EBS PINK	S/M	39/41	BE154039	3	119,99
THOR EBS RED	X/S	36/38	BE155836	3	119,99
THOR EBS RED	S/M	39/41	BE155839	3	119,99
THOR EBS RED	L	42/44	BE155842	3	119,99
THOR EBS RED	XL	45/49	BE155845	3	119,99



ARA EBS SPECIALIZED Retailer-Product

ELASTIC BUNGEE SYSTEM SCUBA FINS

The main feature of this fin is its polypropylene blade that provides an excellent response. And weight is no longer a problem. These fins provide more thrust power to a diver's kicking, which results into an excellent effort/performance ratio. Special grooving for water channelling moulded on the surface provides outstanding stability and direction. The thermorubber foot pocket (with varying levels of hardness) is very comfortable

to wear and a proper fit is ensured by ergonomic design. The heel strap, an exclusive Cressi design, is a special round bungee cord band that perfectly adjusts to all foot sizes and shapes and provides a comfortable, practical and manageable fastening. It features a special ample slot for easy don and doff even when wearing thick gloves for cold-water diving.



PRODUCT	SIZE	EU	CODE	CASE PACK	RRP €
ARA EBS FINS BLACK	S/M	39/41	BE135540	3	129,99
ARA EBS FINS BLACK	M/L	41/43	BE135542	3	129,99
ARA EBS FINS BLACK	L/XL	44/47	BE135544	3	129,99



TECHNICAL FEATURES



Cressi has developed this special strap to meet the needs of the most demanding divers, who need a comfortable fastening for their foot but one that is still practical and manageable. Its special amply sized slot makes it very easy to put on, even when wearing thick gloves or three-fingered gloves for winter water.

The wrapping section is highly flexible, making adjustments unnecessary, and as a result it's much easier to get all your equipment right in the first few meters of your descent and the fin stays in place against your foot despite the increase in hydrostatic pressure.



REACTION EBS

ELASTIC BUNGEE SYSTEM SCUBA FINS

Cressi's most technically advanced fin, the Reaction uses a completely new polypropylene blade material that is more reactive, flexible and trim than previous designs. It kicks easily yet powerfully and is suitable for divers of every experience level. The longer blade efficiently transfers energy from the computer-designed foot pocket, and like other

Cressi fins, the blade extends from the top of the foot pocket to maximize its effective surface area for more thrust. Other innovations include new locking strap buckles and anti-slip material for better traction out of the water.



FINS WEARABILITY:



PRODUCT	SIZE	EU	CODE	CASE PACK	RRP €
REACTION EBS BLUE/AZURE	X/S/S	36/39	BE092038	3	99,99
REACTION EBS BLUE/AZURE	S/M	39/42	BE092040	3	99,99
REACTION EBS BLUE/AZURE	M/L	42/45	BE092042	3	99,99
REACTION EBS BLUE/AZURE	L/XL	45/47	BE092044	3	99,99
REACTION EBS FINS BLACK/SILVER	X/S/S	36/39	BE095538	3	99,99
REACTION EBS FINS BLACK/SILVER	S/M	39/42	BE095540	3	99,99
REACTION EBS FINS BLACK/SILVER	M/L	42/45	BE095542	3	99,99
REACTION EBS FINS BLACK/SILVER	L/XL	45/47	BE095544	3	99,99
REACTION EBS WHITE/PINK	X/S/S	36/39	BE096438	3	99,99
REACTION EBS WHITE/PINK	S/M	39/42	BE096440	3	99,99
REACTION EBS YELLOW/SILVER	X/S/S	36/39	BE091038	3	99,99
REACTION EBS YELLOW/SILVER	S/M	39/42	BE091040	3	99,99
REACTION EBS YELLOW/SILVER	M/L	42/45	BE091042	3	99,99
REACTION EBS YELLOW/SILVER	L/XL	45/47	BE091044	3	99,99

TECHNICAL FEATURES



Cressi has developed this special strap to meet the needs of the most demanding divers, who need a comfortable fastening for their foot but one that is still practical and manageable. Its special amply sized slot makes it very easy to put on, even when wearing thick gloves or three-fingered gloves for winter water.

The wrapping section is highly flexible, making adjustments unnecessary, and as a result it's much easier to get all your equipment right in the first few meters of your descent and the fin stays in place against your foot despite the increase in hydrostatic pressure.



BLUE/AZURE WHITE/PINK YELLOW/SILVER BLACK/SILVER



FROG PLUS

SCUBA FINS

The Frog Plus utilizes Cressi's patented three material injection molding process. The three materials consist of a nice comfortable rubber on the foot pocket that extends up the side rails of the blade. The second material is the revolutionary new dual density techno polymer which forms the blade, and in conjunction with the third silicone based material creates a channeling effect.

Cressi's latest addition to its extensive line of world renowned fins is the Frog Plus open heel scuba diving fin. The Frog Plus features many of the great characteristics of a traditional paddle fin along with introducing a revolutionary new blade material that is both extremely durable and nearly indestructible.



FINS WEARABILITY:



NEOPRENE BOOTS

PRODUCT	SIZE	EU	CODE	*CASE PACK	RRP €
FROG PLUS BLACK/SILVER	X5/S	36/39	BF205538	3	79.99
FROG PLUS BLACK/SILVER	S/M	39/42	BF205540	3	79.99
FROG PLUS BLACK/SILVER	M/L	42/45	BF205542	3	79.99
FROG PLUS BLACK/SILVER	L/XL	45/47	BF205544	3	79.99
FROG PLUS BLACK/YELLOW	X5/S	36/39	BF205138	3	79.99
FROG PLUS BLACK/YELLOW	S/M	39/42	BF205140	3	79.99
FROG PLUS BLACK/YELLOW	M/L	42/45	BF205142	3	79.99
FROG PLUS BLACK/YELLOW	L/XL	45/47	BF205144	3	79.99
FROG PLUS BLUE/SILVER	X5/S	36/39	BF202038	3	79.99
FROG PLUS BLUE/SILVER	S/M	39/42	BF202040	3	79.99
FROG PLUS BLUE/SILVER	M/L	42/45	BF202042	3	79.99
FROG PLUS BLUE/SILVER	L/XL	45/47	BF202044	3	79.99
FROG PLUS BLACK/PINK	X5/S	36/39	BF205438	3	79.99
FROG PLUS BLACK/PINK	S/M	39/42	BF205440	3	79.99
FROG PLUS BLACK/WHITE	X5/S	36/39	BF203038	3	79.99
FROG PLUS BLACK/WHITE	S/M	39/42	BF203040	3	79.99
FROG PLUS BLACK/WHITE	M/L	42/45	BF203042	3	79.99
FROG PLUS BLACK/WHITE	L/XL	45/47	BF203044	3	79.99

TECHNICAL FEATURES

- Made of a combination of 3 materials: Main body in polypropylene, flexible elastomer used in the liner and in areas that require flexibility and elasticity, compact elastomer for side stringers, sole and foot support band.
- Below blade foot pocket.
- Blade profile with decreasing thickness
- Reinforced liner in the upper area
- 360° rotating buckles
- Oversized heel strap
- EBS buckle system



BLACK/SILVER BLACK/YELLOW BLUE/SILVER



BLACK/PINK BLACK/WHITE



OPTIONAL EBS STRAP



PRO LIGHT

SCUBA FINS

A highly advanced design for this fin that is moulded from two materials with very different characteristics: a strong polypropylene for the blade and soft elastomers (thermo rubber) for the foot and protective inserts. The result is an extremely light and well-balanced fin, of average size, with surprising reaction time and a formidable thrust. The side stringers that

extend all along the blade and two flaps situated along the end of the blade itself make the fin very directional. The blade originates from the upper part of the foot pocket, with a 20% increase in useful surface area compared to a traditional fin of the same length. The foot pocket is computer designed and guarantees ideal transmission of the leg-fin thrust.

The lightness and perfect balance of the materials, together with the extremely modern design, make Rondine Pro Light a generous fin that provides exuberant performance without too much physical effort. These fins are perfect both for beginners and for professionals and are very common amongst instructors and technical divers.



BLACK

BLACK/YELLOW

BLACK/BLUE

PINK



OPTIONAL EBS STRAP

FINS WEARABILITY:  **NEOPRENE BOOTS**

PRODUCT	SIZE	EU	CODE	CASE PACK	RRP €
PRO LIGHT BLACK	XS/S	37/39	BG175038	3	69,99
PRO LIGHT BLACK	S/M	40/41	BG175040	3	69,99
PRO LIGHT BLACK	M/L	41/43	BG175042	3	69,99
PRO LIGHT BLACK	L/XL	44/45	BG175044	3	69,99
PRO LIGHT BLACK	XL/2XL	46/47	BG175046	3	69,99
PRO LIGHT BLACK/BLUE	XS/S	37/39	BG172038	3	69,99
PRO LIGHT BLACK/BLUE	S/M	40/41	BG172040	3	69,99
PRO LIGHT BLACK/BLUE	M/L	41/43	BG172042	3	69,99
PRO LIGHT BLACK/BLUE	L/XL	44/45	BG172044	3	69,99
PRO LIGHT BLACK/YELLOW	XS/S	37/39	BG171038	3	69,99
PRO LIGHT BLACK/YELLOW	S/M	40/41	BG171040	3	69,99
PRO LIGHT BLACK/YELLOW	M/L	41/43	BG171042	3	69,99
PRO LIGHT BLACK/YELLOW	L/XL	44/45	BG171044	3	69,99
PRO LIGHT PINK	XS/S	37/39	WBG174038	3	69,99
PRO LIGHT PINK	S/M	40/41	WBG174040	3	69,99



FROG

SCUBA FINS

A classic in the Cressi range, this has been on the market for many years and has a huge number of appreciators in every corner of the planet. The fin is made with a skilful combination of a strong copolymer and a soft elastomer, the latter used for the foot pocket, for the side stringers and for some inserts.

The blade originates from the upper part of the foot pocket, with a 20% increase in useful surface area compared to a traditional fin of the same length. The foot pocket is computer designed and offers great comfort; it guarantees excellent transmission of the leg-fin thrust. The Frog is heavier than the

more recently designed equivalent Cressi models. It is this feature that makes it agreeable to whoever uses very thick suits or watertight suits. Anyone who works underwater will appreciate this fin a great deal because it is strong and comfortable, very popular also in diving schools and excellent for rental



FINS WEARABILITY:  **NEOPRENE BOOTS**

PRODUCT	SIZE	EU	CODE	CASE PACK	RRP €
FROG BLACK	XS/S	36/39	BF195038	3	99,99
FROG BLACK	S/M	39/42	BF195040	3	99,99
FROG BLACK	M/L	42/45	BF195042	3	99,99
FROG BLACK	L/XL	45/47	BF195044	3	99,99

FREE FROG

FULL FOOT FINS

The Free Frog is back! The fin has been remade with the new molding technology. The foot pocket has been improved to fit better to most different foot shapes. The Free Frog enjoys the exclusive characteristics of the Cressi diving fins maintaining the spirit

of the legendary Frog. It features a below blade foot pocket in order to have a bigger surface that increasing the kicking thrust. It is manufactured in a variant of low-modulus polypropylene that, combined with a particular structure, combines great flexibility, softness, and

resistance to a demanding use (even as in rent and school in a diving center), durability and an unprecedented aesthetics in fins projected with this philosophy.



BLACK

BLUE

BLACK/RED

FINS WEARABILITY:

BARE FOOT	NEOPRENE SOCKS

PRODUCT	EU	CODE	*CASE PACK	RRP €
FREE FROG BLACK	37/38	BR155037	3	69,99
FREE FROG BLACK	39/40	BR155039	3	69,99
FREE FROG BLACK	41/42	BR155041	3	69,99
FREE FROG BLACK	43/44	BR155043	3	69,99
FREE FROG BLACK	45/46	BR155045	3	69,99
FREE FROG BLUE	37/38	BR152237	3	69,99
FREE FROG BLUE	39/40	BR152239	3	69,99
FREE FROG BLUE	41/42	BR152241	3	69,99
FREE FROG BLUE	43/44	BR152243	3	69,99
FREE FROG BLUE	45/46	BR152245	3	69,99
FREE FROG BLACK/RED	37/38	JBR155837	3	69,99
FREE FROG BLACK/RED	39/40	JBR155839	3	69,99
FREE FROG BLACK/RED	41/42	JBR155841	3	69,99
FREE FROG BLACK/RED	43/44	JBR155843	3	69,99
FREE FROG BLACK/RED	45/46	JBR155845	3	69,99





Photo by: Wojciech Dopierala



Photo by: Voyages of Agape



Photo by: Wojciech Dopierala



Photo by: Wojciech Dopierala



Photo by: Wojciech Dopierala



GARA TURBO CARBON XLD



SPECIALIZED
Retailer-Product

INTERCHANGEABLE
BLADE
SELF ADJUSTING
FOOT POCKET

SUPERIOR PERFORMANCE CAMOUFLAGE FINS - HIGH FLEXIBILITY BLADE

The blades are made with an ultra performing carbon fibre of incredible strength and flexibility. The fabrication of this carbon fibre is done with an high vacuum 100% industrial procedure, to obtain an exceptional compactness of the carbon fibre. Average carbon fibre used for fin blades in the industry has 3.000 fibers per thread. Our Carbon has 12.000 fibers per thread. Four times as much. Four times the resistance. Four times the flexibility and elasticity, kick response compared to other

carbon blades on the market. Each thread in this carbon fiber is very very small. So small that the TOTAL DENSITY of the blade is an incredible, and unmatched, 20.000 fibers per square millimeter.

Dedicated to those divers who prefer a very soft and smooth fin. It is indicated if your fishing sessions include long sessions and if you cover long distances.

TECHNICAL FEATURES

- 29 degree angled interchangeable carbon blade
- Modular detachable fin
- Superior performance
- Superior comfort
- Self adjusting foot pocket



GARA TURBO
FOOT POCKET

INCLUDED GARA MODULAR INSOLE

The new insole for Gara Modular fins is recommended for use with thin boots in temperate waters, because it improves the kick performance. The semi-rigid material of the insole is completely recycled. The insoles are supplied as a pair (right and left foot) and can be cut into their shape in three different sizes, according to pre-printed guidelines.

- Down-size Gara Fins foot pocket preformed sole
- Easily adjust size
- Non- corrosive plastic construction

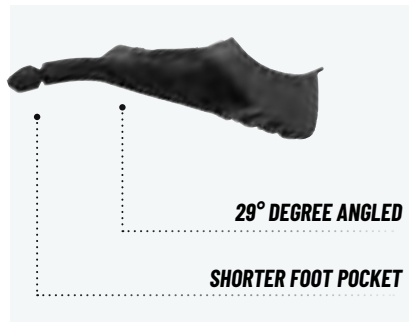

REPRICED %



XLD

FINS WEARABILITY:		
	BARE FOOT	NEOPRENE SOCKS

PRODUCT	CODE	*CASE PACK	RRP €
GARA TURBO CARBON FINS XLD 36/37	BH167036	-	399,99
GARA TURBO CARBON FINS XLD 38/39	BH167038	-	399,99
GARA TURBO CARBON FINS XLD 40/41	BH167040	-	399,99
GARA TURBO CARBON FINS XLD 42/43	BH167042	-	399,99
GARA TURBO CARBON FINS XLD 44/45	BH167044	-	399,99
GARA TURBO CARBON FINS XLD 46/47	BH167046	-	399,99
INSOLE FOR GARA FINS	BZ180022	-	19,99





GARA TURBO CARBON MD SPECIALIZED

INTERCHANGEABLE BLADE
SELF ADJUSTING FOOT POCKET

SUPERIOR PERFORMANCE CAMOUFLAGE FINS - MEDIUM FLEXIBILITY BLADE

The blades are made with an ultra performing carbon fibre of incredible strength and flexibility. The fabrication of this carbon fiber is done with an high vacuum 100% industrial procedure, to obtain an exceptional compactness of the carbon fibre. Average carbon fibre used for fin blades in the industry has 3.000 fibers per thread. Our Carbon has 12.000 fibers per thread. Four times as much. Four times the resistance. Four times the flexibility and elasticity, kick response compared to other

carbon blades on the market. Each thread in this carbon fiber is very very small. So small that the TOTAL DENSITY of the blade is an incredible, and unmatched, 20.000 fibers per square millimeter.

It is perfect if you fish using a boat to move from spot to spot, using a constant weight.

TECHNICAL FEATURES

- 29 degree angled interchangeable carbon blade
- Modular detachable fin
- Superior performance
- Superior comfort
- Self adjusting foot pocket



GARA TURBO FOOT POCKET

INCLUDED GARA MODULAR INSOLE

The new insole for Gara Modular fins is recommended for use with thin boots in temperate waters, because it improves the kick performance. The semi-rigid material of the insole is completely recycled. The insoles are supplied as a pair (right and left foot) and can be cut into their shape in three different sizes, according to pre-printed guidelines.

- Down-size Gara Fins foot pocket preformed sole
- Easily adjust size
- Non- corrosive plastic construction

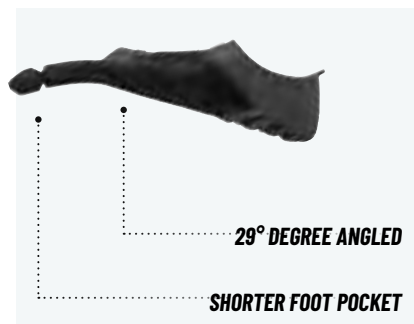

FINS WEARABILITY:	 BARE FOOT	 NEOPRENE SOCKS
-------------------	---	--

PRODUCT	CODE	*CASE PACK	RRP €
GARA TURBO CARBON FINS MD 36/37	BH167536	-	399.99
GARA TURBO CARBON FINS MD 38/39	BH167538	-	399.99
GARA TURBO CARBON FINS MD 40/41	BH167540	-	399.99
GARA TURBO CARBON FINS MD 42/43	BH167542	-	399.99
GARA TURBO CARBON FINS MD 44/45	BH167544	-	399.99
GARA TURBO CARBON FINS MD 46/47	BH167546	-	399.99
INSOLE FOR GARA FINS	BZ180022	-	19.99



GARA TURBO IMPULSE

SPECIALIZED
Retailer-Product

INTERCHANGEABLE
BLADE
SELF ADJUSTING
FOOT POCKET

HIGH PERFORMANCE COMPACT FIN RAILS

Following the Impulse project we have successfully transferred the same design parameters for S-shaped undulating deformation to this innovative fin. This particular movement permits a notable accumulation of elastic potential energy in the blade, which is released in the return kick,

transforming into thrust. The thermoplastic rubber used for the water channelling rails is extremely flexible and soft so as not to undermine the intrinsic characteristics of the blade.

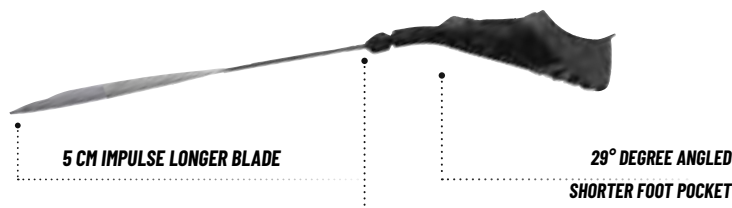

TECHNICAL FEATURES

- Extremely thin and light blade in compound made of elastomerized technopolymers developed by Cressi
- Stringer consisting of technopolymers with elastomeric loads with high flexural modulus
- Footpocket / blade angle of 29 degrees
- Modular detachable fin
- Superior performance
- Superior comfort
- Self adjusting foot pocket



INCLUDED GARA MODULAR INSOLE

The new insole for Gara Modular fins is recommended for use with thin boots in temperate waters, because it improves the kick performance. The semi-rigid material of the insole is completely recycled. The insoles are supplied as a pair (right and left foot) and can be cut into their shape in three different sizes, according to pre-printed guidelines.

- Down-size Gara Fins foot pocket preformed sole
- Easily adjust size
- Non- corrosive plastic construction



PRODUCT	BLACK	BLUE	WHITE	*CASE PACK	RRP €
36/37	BH155036	BH152036	BH153036	3	134,99
38/39	BH155038	BH152038	BH153038	3	134,99
40/41	BH155040	BH152040	BH153040	3	134,99
42/43	BH155042	BH152042	BH153042	3	134,99
44/45	BH155044	BH152044	BH153044	3	134,99
46/47	BH155046	BH152046	BH153046	3	134,99
INSOLE FOR GARA FINS	BZ180022	-	-	-	19,99



Photo by: Wojciech Dopierala

GARA MODULAR IMPULSE



SPECIALIZED
Retailer-Product

INTERCHANGEABLE
BLADE
SELF ADJUSTING
FOOT POCKET

SUPERIOR PERFORMANCE

The blade of the Gara Modular Impulse completes the range of Cressi fins, inserting a bending angle of 29 degrees, which allows you to further increase the dynamic performance of the fin.

The blade has an incredible resistance to any type of shock, impact or stress, making it almost impossible to break accidentally.



WATER RAILS SYSTEM



5 CM IMPULSE LONGER BLADE

29° DEGREE ANGLED

FINS
WEARABILITY:



INCLUDED GARA MODULAR INSOLE

The new insole for Gara Modular fins is recommended for use with thin boots in temperate waters, because it improves the kick performance. The semi-rigid material of the insole is completely recycled. The insoles are supplied as a pair (right and left foot) and can be cut into their shape in three different sizes, according to pre-printed guidelines.

- Down-size Gara Fins foot pocket preformed sole
- Easily adjust size
- Non- corrosive plastic construction



TECHNICAL FEATURES

- Excellent propulsive performance without tiring anyone, beginners or professionals
- Extremely thin and light blade in compound made of elastomerized technopolymers developed by Cressi with different thicknesses
- Stringer consisting of technopolymers with elastomeric loads with high flexural modulus
- Footpocket / blade angle of 29 degrees
- Gara Modular's footpocket is wider than the other gara fin models. We suggest to use it with neoprene socks in order to have a proper fit. For use without neoprene socks, we recommend to buy one smaller size



- LIGHTER
- SOFTER
- 100% PROPULSIVE PERFORMANCE
- MORE EFFICIENCY
- LESS EFFORT
- Anti-slip water rails prevent water flow from escaping sideways
- "Rondine" tail special design improves fin control and directionality

IMPULSE BLADE

STANDARD FINS

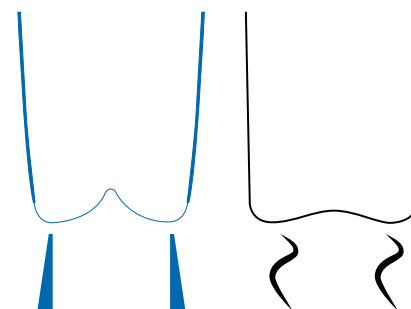

BLUE METAL



BLACK



SIZE	BLACK	BLUE METAL	*CASE PACK		RRP €
36/37	BH095036	BH092036	3		124.99
38/39	BH095038	BH092038	3		124.99
40/41	BH095040	BH092040	3		124.99
42/43	BH095042	BH092042	3		124.99
44/45	BH095044	BH092044	3		124.99
46/47	BH095046	BH092046	3		124.99
INSOLE FOR GARA FINS	BZ180022	-			19.99

GARA TURBO BOOST

SPECIALIZED
Retailer-Product

SELF ADJUSTING
FOOT POCKET

INTERCHANGEABLE
BLADE

AGILITY & PERFORMANCE

The Gara Turbo Boost fin, an evolution of the Impulse design, exploits a revolutionary S-shaped wave deformation technology. This movement allows considerable elastic potential energy to be stored in the blade, which is released in the

return of thrust. This fin is incredibly light, reducing fatigue without compromising performance.

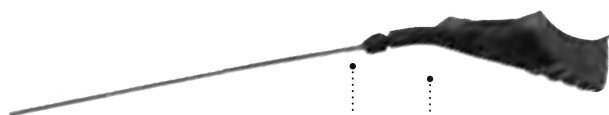

29° DEGREE ANGLED
SHORTER FOOT POCKET

FINS WEARABILITY:		
	BARE FOOT	NEOPRENE SOCKS

PRODUCT	CODE	CASE PACK	RRP €
GARA TURBO BOOST FINS BLACK 36/37	BH185036	3	114,99
GARA TURBO BOOST FINS BLACK 38/39	BH185038	3	114,99
GARA TURBO BOOST FINS BLACK 40/41	BH185040	3	114,99
GARA TURBO BOOST FINS BLACK 42/43	BH185042	3	114,99
GARA TURBO BOOST FINS BLACK 44/45	BH185044	3	114,99
GARA TURBO BOOST FINS BLACK 46/47	BH185046	3	114,99
INSOLE FOR GARA FINS	BZ180022	-	19,99

TECHNICAL FEATURES

- Extremely thin and light blade in compound made of elastomerized technopolymers developed by Cressi
- Stringer consisting of technopolymers with elastomeric loads with high flexural modulus
- Footpocket / blade angle of 29 degrees
- Modular detachable fin
- Superior performance
- Superior comfort
- Self adjusting foot pocket



GARA TURBO
FOOT POCKET

TECHNICAL FEATURES

- Powerful thrust return
- Flexible thermoplastic rubber
- Exceptional lightness
- Reduced fatigue
- Guaranteed superior performance



INCLUDED GARA MODULAR INSOLE

The new insole for Gara Modular fins is recommended for use with thin boots in temperate waters, because it improves the kick performance. The semi-rigid material of the insole is completely recycled. The insoles are supplied as a pair (right and left foot) and can be cut into their shape in three different sizes, according to pre-printed guidelines.

- Down-size Gara Fins foot pocket preformed sole
- Easily adjust size
- Non- corrosive plastic construction



GARA MODULAR BOOST

AGILITY & PERFORMANCE

The Gara Modular Boost fin, an evolution of the Impulse design, exploits a revolutionary S-shaped wave deformation technology. This movement allows considerable elastic potential energy to be stored in the blade, which is released in the

return of thrust. This fin is incredibly light, reducing fatigue without compromising performance.



29° DEGREE ANGLED

FINS WEARABILITY:

BARE FOOT	NEOPRENE SOCKS

PRODUCT	CODE	*CASE PACK	RRP €
GARA MODULAR BOOST FINS GREEN 36/37	BH125036	3	114,99
GARA MODULAR BOOST FINS GREEN 38/39	BH125038	3	114,99
GARA MODULAR BOOST FINS GREEN 40/41	BH125040	3	114,99
GARA MODULAR BOOST FINS GREEN 42/43	BH125042	3	114,99
GARA MODULAR BOOST FINS GREEN 44/45	BH125044	3	114,99
GARA MODULAR BOOST FINS GREEN 46/47	BH125046	3	114,99
INSOLE FOR GARA FINS	BZ180022	-	19,99

SELF ADJUSTING FOOT POCKET | INTERCHANGEABLE BLADE

TECHNICAL FEATURES

- Excellent propulsive performance without tiring anyone, beginners or professionals
- Extremely thin and light blade in compound made of elastomerized technopolymers developed by Cressi with different thicknesses
- Stringer consisting of technopolymers with elastomeric loads with high flexural modulus
- Footpocket / blade angle of 29 degrees
- Gara Modular's footpocket is wider than the other gara fin models, we suggest to use it with neoprene socks in order to have a proper fit, for use without neoprene socks, we recommend to buy one smaller size



TECHNICAL FEATURES

- Powerful thrust return
 - Flexible thermoplastic rubber
 - Exceptional lightness
 - Reduced fatigue
 - Guaranteed superior performance
- **LIGHTER**
 - **SOFTER**
 - **100% PROPULSIVE PERFORMANCE**
 - **MORE EFFICIENCY**
 - **LESS EFFORT**
 - "Rondine" tail special design improves fin control and directionality



INCLUDED GARA MODULAR INSOLE

The new insole for Gara Modular fins is recommended for use with thin boots in temperate waters, because it improves the kick performance. The semi-rigid material of the insole is completely recycled. The insoles are supplied as a pair (right and left foot) and can be cut into their shape in three different sizes, according to pre-printed guidelines.

- Down-size Gara Fins foot pocket preformed sole
- Easily adjust size
- Non- corrosive plastic construction



GARA MODULAR SPRINT



- SUPERIOR COMFORT
- 29° DEGREE ANGLES INTERCHANGEABLE BLADE
- SUPERIOR PERFORMANCE
- SELF ADJUSTING FOOT POCKET

SUPERIOR MANEUVERABILITY

The new Gara Modular Sprint fin is a shorter version of the Impulse fin, which proved to be hugely popular with freedivers worldwide, both amateurs and the most demanding professional freedivers. This is also confirmed by the large number of articles dedicated to it by specialized journalists in sector magazines. Sprint is designed to meet the needs of freedivers and spearfishers who practice this sport in wintertime and when a fin as long as Impulse is not necessary. Both fins have been designed using expensive finite element software programs that allow highly complex and equally high-performance sections to be defined. The blade of Sprint, like the Impulse blade, is made of a single thermoplastic elastomer, although

it would be more correct to refer to an angled sublayer and an overlay. The sublayer follows the shape and dimensions of almost the entire fin. It has a uniform thickness and a flexible longitudinal propulsion wing of variable length. In contrast, the so-called overlay covers the propulsion wing selectively and has a thickness that slopes from the maximum value to zero longitudinally towards the tip of the blade. As a result, the fin offers a new way of storing and releasing elastic potential energy, greatly assisting movement of the freediver's legs and thus guaranteeing a net improvement in propulsive output. When disassembled, the blade and foot pocket occupy the space of a normal snorkeling fin.



WATER RAILS SYSTEM

20 CM SHORTER BLADE

29° DEGREE ANGLED

TECHNICAL FEATURES

- Excellent propulsive performance without tiring anyone, beginners or professionals
- Thermoplastic rubber foot pocket, certified Full Contact
- Standard blade/stringer interface with screws under the foot pocket and side clips
- Extremely thin and light blade in compound made of elastomerized technopolymers developed by Cressi with different thicknesses
- Stringer consisting of technopolymers with elastomeric loads with high flexural modulus
- Foot pocket/blade angle of 29 degrees
- All fin components are also supplied separately.



BLUE METAL



BLACK



INCLUDED GARA MODULAR INSOLE

The new insole for Gara Modular fins is recommended for use with thin boots in temperate waters, because it improves the kick performance. The semi-rigid material of the insole is completely recycled. The insoles are supplied as a pair (right and left foot) and can be cut into their shape in three different sizes, according to pre-printed guidelines.

- Down-size Gara Fins foot pocket preformed sole
- Easily adjust size
- Non- corrosive plastic construction

FIN'S WEARABILITY:		
	BARE FOOT	NEOPRENE SOCKS

PRODUCT	BLUE METAL	BLACK	*CASE PACK	RRP €
36/37	BH082036	BH085036	3	99,99
38/39	BH082038	BH085038	3	99,99
40/41	BH082040	BH085040	3	99,99
42/43	BH082042	BH085042	3	99,99
44/45	BH082044	BH085044	3	99,99
46/47	BH082046	BH085046	3	99,99
INSOLE FOR GARA FINS	BZ180022	-	-	19,99



GARA TURBO FLEX NEW 2025

AGILITY AND HIGH PERFORMANCE COMPACT FINS

The Gara Turbo Flex fin is a lightweight, high-performance evolution of the Turbo Sprint, designed for freedivers and spearfishers. The thin, lightweight blade, made from elastomeric technopolymers developed by Cressi, ensures excellent propulsion with reduced effort, also thanks to the combination with semi-rigid spars that release energy while the fin is in use. The thermoplastic rubber boot, patented and certified

by Cressi as 'Full Contact', guarantees a very precise and flexible fit, thanks to its bi-material construction. The 29-degree angle between the liner and the fin optimises power transmission. The Turbo Flex, while extremely lightweight, offers superior and durable performance, ideal for those looking to get the most out of their equipment.

- | SHORTER BLADE
- | SHORTER FOOT POCKET
- | HIGH PROPULSIVE PERFORMANCE

TECHNICAL FEATURES

- Excellent propulsion performance without excessive fatigue, for beginners and professionals alike
- Thermoplastic rubber liner, Full Contact certified
- Standard sail/rib interface, with screws under the boot and side clips
- Extremely thin and light sail, made from a compound of elastomerised technopolymers in different thicknesses, designed by Cressi
- Lateral ribs in technopolymers with elastomer filler, with a high modulus of flexibility.
- 29 degree angle between foot pocket and blade.
- All fin components also sold separately

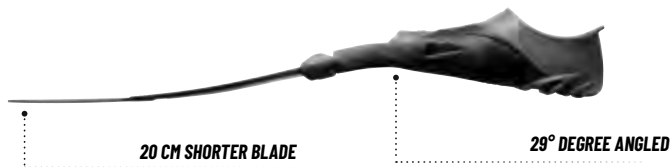

FINS WEARABILITY:

	
BARE FOOT	NEOPRENE SOCKS

PRODUCT	BLACK	WHITE	*CASE PACK		RRP €
GARA TURBO FLEX FINS 36/37	BH195036	BH193036	3		79,99
GARA TURBO FLEX FINS 38/39	BH195038	BH193038	3		79,99
GARA TURBO FLEX FINS 40/41	BH195040	BH193040	3		79,99
GARA TURBO FLEX FINS 42/43	BH195042	BH193042	3		79,99
GARA TURBO FLEX FINS 44/45	BH195044	BH193044	3		79,99
GARA TURBO FLEX FINS 46/47	BH195046	BH193046	3		79,99
INSOLE FOR GARA FINS	BZ180022	BZ180022	-		19,99



INCLUDED GARA MODULAR INSOLE

The new insole for Gara Modular fins is recommended for use with thin boots in temperate waters, because it improves the kick performance. The semi-rigid material of the insole is completely recycled. The insoles are supplied as a pair (right and left foot) and can be cut into their shape in three different sizes, according to pre-printed guidelines.

- Down-size Gara Fins foot pocket preformed sole
- Easily adjust size
- Non- corrosive plastic construction



GARA MODULAR FOOT POCKET

SELF ADJUSTING FOOT POCKET

SIZE	CODE	*CASE PACK	RRP €
36/37 (3/4)	BH005036	-	84,99
38/39 (5/6)	BH005038	-	84,99
40/41 (7/8)	BH005040	-	84,99
42/43 (8/9)	BH005042	-	84,99
44/45 (10/11)	BH005044	-	84,99
46/47 (12/13)	BH005046	-	84,99



GARA TURBO FOOT POCKET

HIGH PERFORMANCE COMPACT FIN RAILS

SIZE	CODE	*CASE PACK	RRP €
36/37 (3/4)	BH015036	-	89,99
38/39 (5/6)	BH015038	-	89,99
40/41 (7/8)	BH015040	-	89,99
42/43 (8/9)	BH015042	-	89,99
44/45 (10/11)	BH015044	-	89,99
46/47 (12/13)	BH015046	-	89,99



GARA ASSEMBLY KIT

ASSEMBLY KIT FOR GARA FINS

PRODUCT	CODE	RRP €
ASSEMBLY KIT GARA MODULAR	BZ180020	14,99



GARA BLADES

PRODUCT SOLD IN SINGLE UNITS*

IMPULSE CARBON

SPECIALIZED
Retailer-Product

XLD MD

IMPULSE

BLACK BLUE METAL WHITE

FIN (X1)	CODE	RRP €
XLD	BH061056	199,99
MD	BH062091	199,99

FIN (X1)	CODE	RRP €
BLACK	BH075000	49,99
BLUE METAL	BH072000	49,99
WHITE	BH073000	49,99

Photo by: Wojciech Dopierala



GARA 3000 LD

SOFTER LONG BLADE

GARA 3000 LD is CRESSI's entry-level long blade fin designed with softer blades, which make the GARA 3000 a perfect choice for the beginning diver or those not familiar using long blade fins. The GARA 3000 is constructed with durability in mind and long soft plastic blades that can effectively transfer power with minimum effort, which make this fin very comfortable and easy on the legs for the beginner or during long duration dives.

The GARA 3000 is an extremely comfortable and is a full footpocket style fin. This fin is also constructed using CRESSI's unique three material molding process where different compounds are bonded together to provide flexibility in the foot area and while being able to deliver power thru the blade due to the stiffness that the multi compound molding process can provide. Can comfortably be worn with or without neoprene socks.



PRODUCT	CODE	*CASE PACK	RRP €
GARA 3000 LD FINS SILVER 40/41 (7/8)	BH135140	3	109.99
GARA 3000 LD FINS SILVER 42/43 (8/9)	BH135142	3	109.99
GARA 3000 LD FINS SILVER 44/45 (10/11)	BH135144	3	109.99
GARA 3000 LD FINS SILVER 46/47 (12/13)	BH135146	3	109.99

SUPERIOR COMFORT | SUPERIOR PERFORMANCE | LONG DISTANCE

TECHNICAL FEATURES

- Durable construction designed for extended use
- Soft long blade for less swimming effort
- Comfy full footpocket
- Cressi three material molding technology



TOTAL LENGTH

SIZE	CM	IN
40/41 (7/8)	87	34.28
42/43 (8/9)	88.50	34.87
44/45 (10/11)	90.50	35.66
46/47 (12/13)	92.50	36.45

BLADE LENGTH

SIZE	CM	IN
40/41 (7/8)	69.50	27.38
42/43 (8/9)	70.50	27.78
44/45 (10/11)	71.50	28.17
46/47 (12/13)	72.50	28.57

MAX WIDTH

SIZE	CM	IN
40/41 (7/8)	21	8.27
42/43 (8/9)	21	8.27
44/45 (10/11)	21.50	8.47
46/47 (12/13)	22.50	8.87

SINGLE FIN WEIGHT

SIZE	GR	LB
40/41 (7/8)	925	2.04
42/43 (8/9)	980	2.16
44/45 (10/11)	1070	2.36
46/47 (12/13)	1165	2.57



GARA 2000 HF

STIFF LONG BLADE

GARA 2000 HF is a staple in the diving industry, and is the first fin in the industry to be manufactured using a three material molding process. Due to its lightweight and durability, it is an excellent choice for those looking for a fin that can provide the ultimate in performance while deep freediving and spearfishing, and those looking for obtaining maximum depths. The GARA 2000 has the stiffest blade in the CRESSI line and is an

extremely comfortable full footpocket style fin, with long firm blades with built in stringers and runners to effectively direct water flow down the blade aiding in efficiency. This fin is constructed using multiple compounds bonded together to provide comfort and suppleness in the foot area and strength and rigidity in the heel and blade area. Can comfortably be worn with or without neoprene socks.

TECHNICAL FEATURES

- Stiff long blade designed for reach max depths
- Comfy full foot pocket
- High performance long blade



FINS WEARABILITY:

BARE FOOT	NEOPRENE SOCKS

PRODUCT	CODE	*CASE PACK	RRP €
GARA 2000 HF FINS BLACK 40/41 (7/8)	BH115040	3	99,99
GARA 2000 HF FINS BLACK 42/43 (8/9)	BH115042	3	99,99
GARA 2000 HF FINS BLACK 44/45 (10/11)	BH115044	3	99,99
GARA 2000 HF FINS BLACK 46/47 (12/13)	BH115046	3	99,99



TOTAL LENGTH

SIZE	CM	IN
40/41 (7/8)	84,50	33,29
42/43 (8/9)	86	33,88
44/45 (10/11)	87,50	34,48
46/47 (12/13)	89	35,07

BLADE LENGTH

SIZE	CM	IN
40/41 (7/8)	66	26
42/43 (8/9)	66	26
44/45 (10/11)	67,50	26,60
46/47 (12/13)	67,50	26,60

MAX WIDTH

SIZE	CM	IN
40/41 (7/8)	21,50	8,47
42/43 (8/9)	21,50	8,47
44/45 (10/11)	22	8,67
46/47 (12/13)	22,30	8,79

SINGLE FIN WEIGHT

SIZE	GR	LB
40/41 (7/8)	790	1,74
42/43 (8/9)	895	1,97
44/45 (10/11)	970	2,14
46/47 (12/13)	1030	2,27



GARA PROFESSIONAL LD

LONG DISTANCE

The Gara Professional LD is a high performance fin, requiring minimum effort to load the long blades. They are more forgiving than other long blade fins for untrained legs, making this an excellent choice for deep free divers and spearfishers of all levels. They are ideal for long distance swimming, while ultimately providing the power and efficiency needed for deep free-diving and spearfishing. Due to the multi compound bonding process used

during the manufacturing process, the Gara Pro LD is an exceptionally soft full footpocket style fin, which provides comfort during prolonged use on those long days in the water. Gara Pro LD delivers maximum power with minimum energy through its long firm blade that runs over the footpocket. Can comfortably be worn with or without neoprene socks.



FINS WEARABILITY:



BARE FOOT



NEOPRENE SOCKS

PRODUCT	CODE	*CASE PACK	RRP €
GARA PROFESSIONAL LD FINS SILVER 40/41 (7/8)	BH145140	3	79.99
GARA PROFESSIONAL LD FINS SILVER 42/43 (8/9)	BH145142	3	79.99
GARA PROFESSIONAL LD FINS SILVER 44/45 (10/11)	BH145144	3	79.99
GARA PROFESSIONAL LD FINS SILVER 46/47 (12/13)	BH145146	3	79.99



TOTAL LENGTH

SIZE	CM	IN
40/41 (7/8)	87	34.28
42/43 (8/9)	89	35.07
44/45 (10/11)	90	35.46
46/47 (12/13)	91.50	36.05

BLADE LENGTH

SIZE	CM	IN
40/41 (7/8)	73	28.76
42/43 (8/9)	75	29.55
44/45 (10/11)	75	29.55
46/47 (12/13)	77	30.34

MAX WIDTH

SIZE	CM	IN
40/41 (7/8)	22	8.67
42/43 (8/9)	22.50	8.87
44/45 (10/11)	23.30	9.18
46/47 (12/13)	24.20	9.53

SINGLE FIN WEIGHT

SIZE	GR	LB
40/41 (7/8)	890	1.96
42/43 (8/9)	960	2.12
44/45 (10/11)	990	2.18
46/47 (12/13)	1055	2.33





Photo by: Wojciech Dopierala



Photo by: Wojciech Dopierala



Photo by: Wojciech Dopierala

REACTION PRO

FULL FOOT FINS

REACTION PRO is a great all around fin for scuba, snorkeling and freediving. The REACTION PRO is a full foot pocket style fin, with a longer blade and built in runners to effectively direct water flow down the blade. REACTION PRO is constructed using multiple materials bonded together with a patented three material molding process to

provide comfort and suppleness in the foot area and strength and rigidity in the heel and blade area, where the foot pocket is beneath the blade for added power and efficiency. The soles are completely covered in thermo-rubber to give them exceptional grip on boat decks. Can comfortably be worn with or without neoprene socks.

SUPERIOR PERFORMANCE

COMFORTABLE FULL FOOT POCKET

TECHNICAL FEATURES

- Full foot pocket for comfort
- Long blade for efficiency
- Thermo-Rubber soles for extra grip on wet surfaces



BLUE/AZURE

BLACK/SILVER

YELLOW/SILVER

TOTAL LENGTH

SIZE	CM	IN
36/37 (3/4)	60	23.64
38/39 (5/6)	62	24.43
40/41 (7/8)	64	25.22
42/43 (8/9)	66.5	26.2
44/45 (10/11)	68	26.79
46/47 (12/13)	70	27.58

BLADE LENGTH

SIZE	CM	IN
36/37 (3/4)	47.5	18.72
38/39 (5/6)	49.5	19.5
40/41 (7/8)	50	19.7
42/43 (8/9)	52	20.49
44/45 (10/11)	54.5	21.47
46/47 (12/13)	55.5	21.87

MAX WIDTH

SIZE	CM	IN
36/37 (3/4)	20.3	8
38/39 (5/6)	21	8.27
40/41 (7/8)	21.5	8.47
42/43 (8/9)	22.5	8.87
44/45 (10/11)	23	9.06
46/47 (12/13)	23.7	9.34

SINGLE FIN WEIGHT

SIZE	GR	LB
36/37 (3/4)	625	1.38
38/39 (5/6)	710	1.57
40/41 (7/8)	765	1.69
42/43 (8/9)	830	1.83
44/45 (10/11)	880	1.94
46/47 (12/13)	935	2.06



FINS WEARABILITY:



PRODUCT	EU	CODE	CASE PACK	RRP €
REACTION PRO BLUE/AZURE	36/37	BG192036	3	64,99
REACTION PRO BLUE/AZURE	38/39	BG192038	3	64,99
REACTION PRO BLUE/AZURE	40/41	BG192040	3	64,99
REACTION PRO BLUE/AZURE	42/43	BG192042	3	64,99
REACTION PRO BLUE/AZURE	44/45	BG192044	3	64,99
REACTION PRO BLUE/AZURE	46/47	BG192046	3	64,99
REACTION PRO BLACK/SILVER	36/37	BG195036	3	64,99
REACTION PRO BLACK/SILVER	38/39	BG195038	3	64,99
REACTION PRO BLACK/SILVER	40/41	BG195040	3	64,99
REACTION PRO BLACK/SILVER	42/43	BG195042	3	64,99
REACTION PRO BLACK/SILVER	44/45	BG195044	3	64,99
REACTION PRO BLACK/SILVER	46/47	BG195046	3	64,99
REACTION PRO YELLOW/SILVER	36/37	BG191036	3	64,99
REACTION PRO YELLOW/SILVER	38/39	BG191038	3	64,99
REACTION PRO YELLOW/SILVER	40/41	BG191040	3	64,99
REACTION PRO YELLOW/SILVER	42/43	BG191042	3	64,99
REACTION PRO YELLOW/SILVER	44/45	BG191044	3	64,99
REACTION PRO YELLOW/SILVER	46/47	BG191046	3	64,99

VERSATILE AND LIGHTWEIGHT

COMFORTABLE FULL FOOT POCKET

PRO STAR

FULL FOOT FINS

PRO STAR is yet another versatile fin in the CRESSI line and is an exceptional choice for Scuba, Snorkeling and Freediving. Inspired by the PRO LIGHT, The PRO STAR is a lightweight and comfortable full foot pocket style fin. For power transference, it incorporates the blade beneath the foot pocket and the angle of the blade provides

the ultimate in efficiency during the kick cycle requiring less energy to load the blade. This fin is constructed using multiple compounds bonded together to provide comfort around the foot, yet strong enough to transfer strength where needed. Can comfortably be worn with or without neoprene socks.



TECHNICAL FEATURES

- Full foot pocket for comfort
- Long blade for efficiency



BLACK



YELLOW

TOTAL LENGTH

SIZE	CM	IN
37/38 (4/5)	60	23.64
39/40 (5.5/6.5)	62.5	24.63
41/42 (7/8)	64.5	25.41
43/44 (8.5/9.5)	66.5	26.2
45/46 (10/11)	68.5	26.99

BLADE LENGTH

SIZE	CM	IN
37/38 (4/5)	50	19.7
39/40 (5.5/6.5)	50.5	19.9
41/42 (7/8)	52	20.49
43/44 (8.5/9.5)	54.5	21.47
45/46 (10/11)	56.5	22.26

MAX WIDTH

SIZE	CM	IN
37/38 (4/5)	20	7.88
39/40 (5.5/6.5)	20.5	8.08
41/42 (7/8)	21	8.27
43/44 (8.5/9.5)	21.5	8.47
45/46 (10/11)	22	8.67

SINGLE FIN WEIGHT

SIZE	CM	IN
37/38 (4/5)	575	1.27
39/40 (5.5/6.5)	615	1.36
41/42 (7/8)	645	1.42
43/44 (8.5/9.5)	710	1.57
45/46 (10/11)	790	1.74

FINS WEARABILITY:

 BARE FOOT

 NEOPRENE SOCKS

PRODUCT	EU	CODE	CASE PACK	RRP €
PRO STAR BLACK	37/38	BG185037	4	54,99
PRO STAR BLACK	39/40	BG185039	4	54,99
PRO STAR BLACK	41/42	BG185041	4	54,99
PRO STAR BLACK	43/44	BG185043	4	54,99
PRO STAR BLACK	45/46	BG185045	4	54,99
PRO STAR YELLOW	37/38	BG181037	4	54,99
PRO STAR YELLOW	39/40	BG181039	4	54,99
PRO STAR YELLOW	41/42	BG181041	4	54,99
PRO STAR YELLOW	43/44	BG181043	4	54,99
PRO STAR YELLOW	45/46	BG181045	4	54,99



MAUI

OPEN HEEL SNORKELING FINS

The principal characteristics of the Maui fin are lightness and ease of use, even for those without well-trained legs. Its weight and dimensions make it easy to stow, but without compromising performance.

The Maui has been designed with the same sophisticated and advanced finite elements technology used for the first time on the Impulse and Sprint models.

The dual material technology used for the blade means that it is substantially composed of two rigid lateral wings that direct the flow of water

to the central section, where the overlaying of a softer and more elastic material makes it more flexible. In this way the blade flexes to create a "spoon effect", thereby contributing considerable propulsive force.

The fin can be used with bare feet or light socks. The fabric covering of the EBS strap prevents perishing of the elastic elements.

The heel piece is in soft, anatomical rubber. The grab handle for fitting the fin wraps around the ankle so as to reduce protrusion and avoid chafing

while swimming.

Even though the EBS itself permits great adaptability and makes donning the fin particularly easy, we have fitted a cleat to the elastic strap to permit further adjustment. This function permits the user to obtain micro-adjustments – depending on whether they are wearing a sock or not – or simply to loosen or tighten to ensure the foot is held firmly in place but without excessive pressure. Dive Centres fins will have heel pieces colour-coded according to sizes to facilitate identification.



FINS WEARABILITY:



DIVE CENTER Product edition



BLACK/BLUE



BLACK/RED

EBS STRAPS FOR DIVE CENTER VERSION

Dive Centers Maui fins will have heel pieces colour-coded according to sizes to facilitate identification:



ALL SIZES
BLUE STRAP

DIVE CENTER Product edition



L/XL
GREY STRAP

M/L
BLACK STRAP

S/M
RED STRAP

PRODUCT	SIZE	CODE	*CASE PACK	RRP €
MAUI FINS BLUE/AZURE	S/M	CA155238	6	59,99
MAUI FINS BLUE/AZURE	M/L	CA155241	6	59,99
MAUI FINS BLUE/AZURE	L/XL	CA155244	6	59,99
EBS STRAPS MAUI BLUE (2pcs)	-	CZ145200	-	26,99
PRODUCT	SIZE	CODE	*CASE PACK	RRP €
MAUI FINS DIV-CEN BLACK/RED	S/M	CA155838	6	59,99
MAUI FINS DIV-CEN BLACK/RED	M/L	CA155841	6	59,99
MAUI FINS DIV-CEN BLACK/RED	L/XL	CA155844	6	59,99
EBS STRAPS MAUI GREY (2pcs)	-	CZ145550	-	26,99
EBS STRAPS MAUI BLACK (2pcs)	-	CZ145500	-	26,99
EBS STRAPS MAUI RED (2pcs)	-	CZ145800	-	26,99



MAUI SHORT

OPEN HEEL SNORKELING FINS

Maui short is a short fin, ideal for swimming in open and confined waters, and for snorkeling. For its robustness and practicality, is the ideal fin for safety and rescue teams operating on beaches. Maui short has been developed using the same calculation programs that we used to design on Impulse and Sprint fins, and on her "big sister" Maui. Two side rails, built in two different materials, convey the water towards the central part of the blade. The combination of a softer material and a stiffer one makes this fin extremely soft and

extremely performing at the same time. When the blade flexes it creates a "spoon" effect and bouncing back in position it emits a great propelling power in return.

The strap is built using an EBS system made of elastic rubbers, with a nylon lining, that guarantees a very long duration and resistance to abrasion. The heel is made of soft rubber, cut in an anatomic shape. This fin can be used with or without neoprene socks.

The handle is wrapped around the heel, so that it does not interfere with the movement of legs and feet when swimming. The EBS system is very stable on its own, but we added a choker on the elastic bands to allow a fine tuning of the fin and to avoid an unwanted release.

Maui short is a fin for swimming in the sea or in the swimming-pool, it can be used for snorkeling and it's the fin of choice for rescue teams operating on beaches.



MAUI EBS STRAP



FINS WEARABILITY:

BARE FOOT	NEOPRENE SOCKS

PRODUCT	SIZE	CODE	*CASE PACK	RRP €
MAUI SHORT FINS BLUE/AZURE	S/M	CA165238	6	49,99
MAUI SHORT FINS BLUE/AZURE	M/L	CA165241	6	49,99
MAUI SHORT FINS BLUE/AZURE	L/XL	CA165244	6	49,99
EBS STRAPS MAUI BLUE (2pcs)	-	CZ145200	-	26,99

PALAU

OPEN HEEL SNORKELING FINS

These open heel snorkel fins are made for use with bare feet and provide outstanding comfort and versatility. The open-heel design means each fin can accommodate a wider range of sizes, so family members or friends can share equipment more easily. It also allows dive schools or rental

departments to stock fewer sizes while providing very high-quality fins to customers. The Palau's blade delivers excellent thrust with a modest kicking effort. snorkelling, free diving, and long swims.

TECHNICAL FEATURES

- Open heel foot pocket designed for bare feet
- Soft elastomer material delivers outstanding comfort
- Ideal for sharing among family and friends or for rental departments
- Easy-kicking blade responds well to any kicking style
- Blade extends from the top of the foot pocket for maximum surface area
- 5 fin sizes cover shoe sizes from 32 to 47 (European).



BLUE/AZURE BLACK/YELLOW BLACK/PINK



FINS WEARABILITY:

 BARE FOOT

 NEOPRENE SOCKS

PRODUCT	SIZE	EU	CODE	CASE PACK	RRP €
PALAU BLUE/AZURE	KID	29/32	CA112029	6	39,99
PALAU BLUE/AZURE	2XS/XS	32/35	CA112032	6	39,99
PALAU BLUE/AZURE	XS/S	35/38	CA112035	6	39,99
PALAU BLUE/AZURE	S/M	38/41	CA112038	6	39,99
PALAU BLUE/AZURE	M/L	41/44	CA112041	6	39,99
PALAU BLUE/AZURE	L/XL	44/47	CA112044	6	39,99
PALAU BLACK/YELLOW	2XS/XS	32/35	CA115132	6	39,99
PALAU BLACK/YELLOW	XS/S	35/38	CA115135	6	39,99
PALAU BLACK/YELLOW	S/M	38/41	CA115138	6	39,99
PALAU BLACK/YELLOW	M/L	41/44	CA115141	6	39,99
PALAU BLACK/YELLOW	L/XL	44/47	CA115144	6	39,99
PALAU BLACK/PINK	2XS/XS	32/35	CA115432	6	39,99
PALAU BLACK/PINK	XS/S	35/38	CA115435	6	39,99
PALAU BLACK/PINK	S/M	38/41	CA115438	6	39,99





IDEAL FOR TRAVEL



MADE IN ITALY

SUPERIOR COMFORT

BELOW BLADE FOOT POCKET

PALAU SAF

SHORT BLADE SNORKELING FINS

A true sports fin, the Palau Short Adjustable Fin (SAF) is ideal for active water sports enthusiasts. Short and easy to *CASE PACK, it's the ultimate travel companion and is suitable for snorkeling,

swimming, body surfing, boogie boards and much more. The soft open-heel foot pockets are designed for bare feet and provide a great fit for multiple sizes.

TECHNICAL FEATURES

- Open heel foot pocket designed for bare feet
- Soft elastomer material delivers outstanding comfort
- Ideal for sharing among family and friends or for rental departments
- Short blade
- Blade extends from the top of the foot pocket for maximum surface area



BLUE/AZURE

BLACK/YELLOW

BLACK/PINK

FINS WEARABILITY:

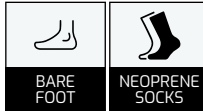

PRODUCT	SIZE	EU	CODE	*CASE PACK	RRP €
PALAU SAF BLUE/AZURE	XS/S	35/38	CA132035	6	39,99
PALAU SAF BLUE/AZURE	S/M	38/41	CA132038	6	39,99
PALAU SAF BLUE/AZURE	M/L	41/44	CA132041	6	39,99
PALAU SAF BLUE/AZURE	L/XL	44/47	CA132044	6	39,99
PALAU SAF BLACK/YELLOW	XS/S	35/38	CA135135	6	39,99
PALAU SAF BLACK/YELLOW	S/M	38/41	CA135138	6	39,99
PALAU SAF BLACK/YELLOW	M/L	41/44	CA135141	6	39,99
PALAU SAF BLACK/YELLOW	L/XL	44/47	CA135144	6	39,99
PALAU SAF BLACK/PINK	XS/S	35/38	CA135435	6	39,99
PALAU SAF BLACK/PINK	S/M	38/41	CA135438	6	39,99



PLUMA

FULL FOOT SNORKELING FINS

This high-tech fin designed specifically for snorkeling benefits from the best technologies used in free diving and scuba diving. Cressi's unique molding process also allows for the use of three separate materials to create a highly-responsive

blade. Now, snorkelers can power through current and enjoy hours on the water without undue muscle strain. The Pluma's computer-designed foot pocket provides excellent power transmission and unparalleled comfort.

LONG BLADE | BELOW BLADE FOOT POCKET

TECHNICAL FEATURES

- Patented Cressi molding
- Technology used to create lightweight, responsive blade
- Computer designed foot pocket with stiff base better transmits power down the blade
- Soft thermo-rubber foot pocket material is comfortable for extended wear
- Lightweight polypropylene blade is easy to "CASE PACK"
- Blade ribs provide precise flex control for maximum thrust
- Excellent value



BLUE/AZURE



BLACK/SILVER



FINS WEARABILITY:		
	BARE FOOT	NEOPRENE SOCKS

PRODUCT	EU	CODE	CASE PACK	RRP €
PLUMA BLUE/AZURE	35/36	CA172035	6	39.99
PLUMA BLUE/AZURE	37/38	CA172037	6	39.99
PLUMA BLUE/AZURE	39/40	CA172039	6	39.99
PLUMA BLUE/AZURE	41/42	CA172041	6	39.99
PLUMA BLUE/AZURE	43/44	CA172043	6	39.99
PLUMA BLUE/AZURE	45/46	CA172045	6	39.99
PLUMA BLACK/SILVER	35/36	CA175035	6	39.99
PLUMA BLACK/SILVER	37/38	CA175037	6	39.99
PLUMA BLACK/SILVER	39/40	CA175039	6	39.99
PLUMA BLACK/SILVER	41/42	CA175041	6	39.99
PLUMA BLACK/SILVER	43/44	CA175043	6	39.99
PLUMA BLACK/SILVER	45/46	CA175045	6	39.99

AGUA

FULL FOOT SNORKELING FINS

Agua is a very easy fin to use, and doesn't require any special athletic or water-sport abilities, yet it still delivers excellent performance without tiring your feet. Thanks to the latest technology and

Cressi's experience in developing these products, we've been able to markedly decrease the weight of this fin compared to others in its category, while still preserving excellent responsiveness.

LONG BLADE ABOVE BLADE FOOT POCKET SELF ADJUSTING FOOT POCKET



KID SIZE	EU	CODE	CASE PACK	WEARABILITY	RRP €	
AGUA KID AQUAMARINE	31/32	CA206331	6	BARE FOOT NEOPRENE SOCKS	29.99	
AGUA KID AQUAMARINE	33/34	CA206333	6		29.99	
AGUA KID PINK	31/32	CA206431	6		29.99	
AGUA KID PINK	33/34	CA206433	6		29.99	
ADULT SIZE	EU	CODE	CASE PACK		WEARABILITY	RRP €
AGUA BLACK	35/36	CA205035	6		BARE FOOT NEOPRENE SOCKS	34.99
AGUA BLACK	37/38	CA205037	6			34.99
AGUA BLACK	39/40	CA205039	6			34.99
AGUA BLACK	41/42	CA205041	6	34.99		
AGUA BLACK	43/44	CA205043	6	34.99		
AGUA BLACK	45/46	CA205045	6	34.99		
AGUA BLUE	35/36	CA206235	6	34.99		
AGUA BLUE	37/38	CA206237	6	34.99		
AGUA BLUE	39/40	CA206239	6	34.99		
AGUA BLUE	41/42	CA206241	6	34.99		
AGUA BLUE	43/44	CA206243	6	34.99		
AGUA BLUE	45/46	CA206245	6	34.99		
AGUA YELLOW	35/36	CA201035	6	34.99		
AGUA YELLOW	37/38	CA201037	6	34.99		
AGUA YELLOW	39/40	CA201039	6	34.99		
AGUA YELLOW	41/42	CA201041	6	34.99		
AGUA YELLOW	43/44	CA201043	6	34.99		
AGUA YELLOW	45/46	CA201045	6	34.99		
AGUA AQUAMARINE	35/36	CA206335	6	34.99		
AGUA AQUAMARINE	37/38	CA206337	6	34.99		
AGUA AQUAMARINE	39/40	CA206339	6	34.99		
AGUA AQUAMARINE	41/42	CA206341	6	34.99		
AGUA AQUAMARINE	43/44	CA206343	6	34.99		
AGUA AQUAMARINE	45/46	CA206345	6	34.99		
AGUA PINK	35/36	CA206435	6	34.99		
AGUA PINK	37/38	CA206437	6	34.99		
AGUA PINK	39/40	CA206439	6	34.99		

The foot pocket features the original Self Adjusting Foot Pocket system, which thanks to the special softness and elasticity of the blends makes for a consistently soft and adherent fit.



RONDINELLA

FULL FOOT SNORKELING FINS

All of Cressi's fifty-year experience has gone into these fins, which are a modern revival of the successful principles of the glorious light blue rubber Rondine fins. The blade is made from light and at the same time reactive polypropylene

and during moulding is coalesced with a soft, flexible thermo-rubber (elastomer), used for the foot pocket, for the frames and for some inserts. This mix makes the Rondinella fins light and powerful: they are easy to use, not too

demanding, and perform generously at the same time. The computer-designed foot is enveloping and anatomical, making it easy to put them on and perfect for extended use. Rondinella fins are perfect for snorkelling, free diving, and long swims.



FINS WEARABILITY:



BARE FOOT



NEOPRENE SOCKS

KID SIZE	EU	CODE	CASE PACK	RRP €
RONDINELLA BLUE	29/30	CA182029	6	24,99
RONDINELLA BLUE	31/32	CA182031	6	24,99
RONDINELLA BLUE	33/34	CA182033	6	24,99
RONDINELLA AQUAMARINE	29/30	CA186329	6	24,99
RONDINELLA AQUAMARINE	31/32	CA186331	6	24,99
RONDINELLA AQUAMARINE	33/34	CA186333	6	24,99
ADULT SIZE	EU	CODE	CASE PACK	RRP €
RONDINELLA YELLOW	35/36	CA181035	6	29,99
RONDINELLA YELLOW	37/38	CA181037	6	29,99
RONDINELLA YELLOW	39/40	CA181039	6	29,99
RONDINELLA YELLOW	41/42	CA181041	6	29,99
RONDINELLA YELLOW	43/44	CA181043	6	29,99
RONDINELLA YELLOW	45/46	CA181045	6	29,99
RONDINELLA BLUE	35/36	CA182035	6	29,99
RONDINELLA BLUE	37/38	CA182037	6	29,99
RONDINELLA BLUE	39/40	CA182039	6	29,99
RONDINELLA BLUE	41/42	CA182041	6	29,99
RONDINELLA BLUE	43/44	CA182043	6	29,99
RONDINELLA BLUE	45/46	CA182045	6	29,99
RONDINELLA BLUE	47/48	CA182047	6	29,99
RONDINELLA AQUAMARINE	35/36	CA186335	6	29,99
RONDINELLA AQUAMARINE	37/38	CA186337	6	29,99
RONDINELLA AQUAMARINE	39/40	CA186339	6	29,99
RONDINELLA AQUAMARINE	41/42	CA186341	6	29,99
RONDINELLA AQUAMARINE	43/44	CA186343	6	29,99
RONDINELLA AQUAMARINE	45/46	CA186345	6	29,99
RONDINELLA AQUAMARINE	47/48	CA186347	6	29,99



CLIO

FULL FOOT SNORKELING FINS

Simple to use and highly durable, the Clio is a favorite snorkel fin for anyone on a budget. It combines a responsive blade and soft, easy-to-

don foot pocket and works well for all ages. The Clio's great value also makes it a good choice for dive schools and rental departments.



FINS WEARABILITY:



KID SIZE	EU	CODE	CASE PACK	RRP €
CLIO YELLOW	27/29	CA101027	6	29.99
CLIO YELLOW	30/32	CA101030	6	29.99
CLIO YELLOW	33/34	CA101033	6	29.99
CLIO BLUE	27/29	CA102027	6	29.99
CLIO BLUE	30/32	CA102030	6	29.99
CLIO BLUE	33/34	CA102033	6	29.99
ADULT SIZE	EU	CODE	CASE PACK	RRP €
CLIO YELLOW	35/36	CA101035	6	34.99
CLIO YELLOW	37/38	CA101037	6	34.99
CLIO YELLOW	39/40	CA101039	6	34.99
CLIO YELLOW	41/42	CA101041	6	34.99
CLIO YELLOW	43/44	CA101043	6	34.99
CLIO YELLOW	45/46	CA101045	6	34.99
CLIO BLUE	35/36	CA102035	6	34.99
CLIO BLUE	37/38	CA102037	6	34.99
CLIO BLUE	39/40	CA102039	6	34.99
CLIO BLUE	41/42	CA102041	6	34.99
CLIO BLUE	43/44	CA102043	6	34.99
CLIO BLUE	45/46	CA102045	6	34.99
CLIO BLUE	47/48	CA102047	6	34.99
CLIO BLACK	35/36	CA105035	6	34.99
CLIO BLACK	37/38	CA105037	6	34.99
CLIO BLACK	39/40	CA105039	6	34.99
CLIO BLACK	41/42	CA105041	6	34.99
CLIO BLACK	43/44	CA105043	6	34.99
CLIO BLACK	45/46	CA105045	6	34.99
CLIO BLACK	47/48	CA105047	6	34.99

TECHNICAL FEATURES

- Responsive blade delivers good power with any kicking style
- Supple, elastomer foot pocket is easy to slip on and off
- Durable and economical, ideal for rental departments



AGUA SHORT

SHORT BLADE SWIMMING FINS

The Cressi Agua Short Swim Fin is the shorter more versatile version of Cressi's popular Aqua long blade fin. The Agua Short Fin is ideal for travelers and is the perfect swim aid while in the pool or open water. This fin features a self-

adjusting foot pocket for incredible flexibility and comfort. It is perfect for any level of experience and is a must-have on your next vacation or work-out.



SOFT ULTRA FLEXIBLE MATERIAL



BLUE

BLACK/SILVER



FINS WEARABILITY:



BARE FOOT



NEOPRENE SOCKS

KID SIZE	EU	CODE	CASE PACK	RRP €
AGUA SHORT BLUE	31/32	DP206231	3	34,99
AGUA SHORT BLUE	33/34	DP206233	3	34,99
ADULT SIZE	EU	CODE	CASE PACK	RRP €
AGUA SHORT BLUE	35/36	DP206235	3	34,99
AGUA SHORT BLUE	37/38	DP206237	3	34,99
AGUA SHORT BLUE	39/40	DP206239	3	34,99
AGUA SHORT BLUE	41/42	DP206241	3	34,99
AGUA SHORT BLUE	43/44	DP206243	3	34,99
AGUA SHORT BLUE	45/46	DP206245	3	34,99
AGUA SHORT BLUE	47/48	DP206247	3	34,99
AGUA SHORT BLACK/SILVER	35/36	DP205035	3	34,99
AGUA SHORT BLACK/SILVER	37/38	DP205037	3	34,99
AGUA SHORT BLACK/SILVER	39/40	DP205039	3	34,99
AGUA SHORT BLACK/SILVER	41/42	DP205041	3	34,99
AGUA SHORT BLACK/SILVER	43/44	DP205043	3	34,99
AGUA SHORT BLACK/SILVER	45/46	DP205045	3	34,99
AGUA SHORT BLACK/SILVER	47/48	DP205047	3	34,99

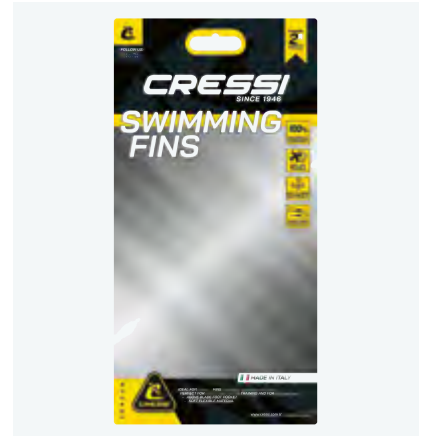

LIGHT

SHORT BLADE SWIMMING FINS

The Cressi Light are specifically designed for pool use and for swim training, but can also be used adequately for recreational swimming and snorkeling.

The short blade is made of a highly reactive and light material which guarantees agile and effective kicking while not tiring out your legs. The length of the blade has been researched and studied by Cressi to ensure perfect muscle training without

causing cramps or discomfort. The anatomically designed foot pocket is made from soft rubber elastomers, and it houses the foot with a great deal of comfort, even during long swimming sessions.

WHO IT IS FOR:

The Light Fins have been specifically designed for training and to build up muscles, but they can also be used for recreational swimming and snorkeling.



SOFT ULTRA FLEXIBLE MATERIAL



BLUE

WHITE



FINS WEARABILITY:



BARE FOOT

NEOPRENE SOCKS

KID SIZE	EU	CODE	CASE PACK	RRP €
LIGHT WHITE	31/32	DP183031	3	29,99
LIGHT WHITE	33/34	DP183033	3	29,99
LIGHT BLUE	31/32	DP182031	3	29,99
LIGHT BLUE	33/34	DP182033	3	29,99
ADULT SIZE	EU	CODE	CASE PACK	RRP €
LIGHT WHITE	35/36	DP183035	3	29,99
LIGHT WHITE	37/38	DP183037	3	29,99
LIGHT WHITE	39/40	DP183039	3	29,99
LIGHT WHITE	41/42	DP183041	3	29,99
LIGHT WHITE	43/44	DP183043	3	29,99
LIGHT WHITE	45/46	DP183045	3	29,99
LIGHT BLUE	35/36	DP182035	3	29,99
LIGHT BLUE	37/38	DP182037	3	29,99
LIGHT BLUE	39/40	DP182039	3	29,99
LIGHT BLUE	41/42	DP182041	3	29,99
LIGHT BLUE	43/44	DP182043	3	29,99
LIGHT BLUE	45/46	DP182045	3	29,99

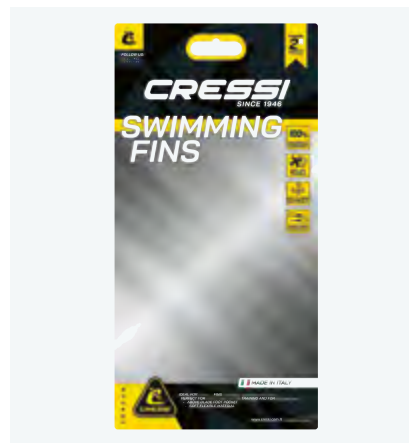

PURA

NEW COLOR 2025

100% COMFORTABLE SILICONE

INTENSIVE TRAINING

OPEN HEEL SILICONE SNORKELING AND SWIMMING FINS

Pura swimming fins are made from highly versatile and comfortable silicone. These fins are designed for swimmers who want to train their legs and ankles intensively, increasing strength in the abdominal and lumbar region. Made from 100% silicone, Pura fins are easy to wear. These

short fins perfectly complement the Cressi line dedicated to swimming. These fins are ideal for family snorkelling outings and provide hours of underwater exploration.

TECHNICAL FEATURES

- Versatility and comfort
- Intensive training
- 100% silicone



BLUE



NEW

BLACK/YELLOW



FINS WEARABILITY: BARE FOOT

PRODUCT	SIZE	EU	BLUE	BLACK/YELLOW	*CASE PACK	RRP €
PURA FINS LIGHT	XS	35 - 37	XCA602035	XCA605235	3	39,99
PURA FINS LIGHT	S	38 - 40	XCA602038	XCA605238	3	39,99
PURA FINS LIGHT	M	40 - 42	XCA602040	XCA605240	3	39,99
PURA FINS LIGHT	L	43 - 45	XCA602043	XCA605243	3	39,99
PURA FINS LIGHT	XL	45 - 47	XCA602045	XCA605245	3	39,99

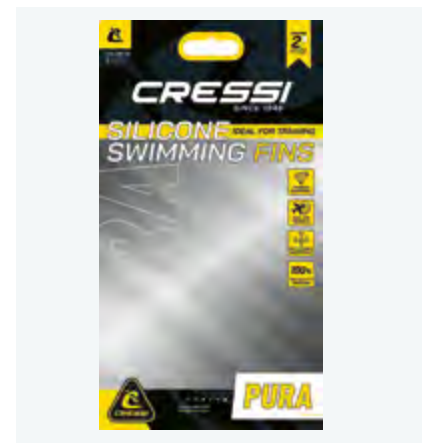

VERA

NEW 2025

CLOSED FOOT POCKET

100% COMFORTABLE SILICONE

INTENSIVE TRAINING

SNORKELING AND SWIMMING FINS IN SILICON

Cressi Vera swim fins are made from 100% high-quality silicone, with a closed foot pocket. Whether you're training in the pool or exploring the open water, the durable silicone ensures long-lasting performance and exceptional resistance to wear and tear. The versatility and comfort of these swim

fins make them an ideal choice for swimmers looking to improve their skills, increase their endurance or simply enjoy a leisurely swim.

TECHNICAL FEATURES

- Versatility and comfort
- Intensive training
- 100% silicone



AQUAMARINE



BLUE

FINS WEARABILITY:



BARE FOOT

PRODUCT	SIZE	EU	BLUE	AQUAMARINE	*CASE PACK	RRP €
VERA FINS LIGHT	S	36-38	XCA612236	XCA612336	3	39,99
VERA FINS LIGHT	M	39-41	XCA612239	XCA612339	3	39,99
VERA FINS LIGHT	L	42-44	XCA612242	XCA612342	3	39,99
VERA FINS LIGHT	XL	45-47	XCA612245	XCA612345	3	39,99

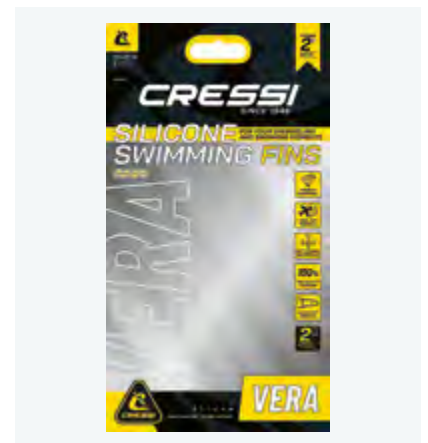

ROCKS

KIDS SNORKELING FINS

The Rocks is a composite fin with an adjustable open heel and an adjustable strap designed to follow the child's growth. The strap has a large thumb loop for easy donning and doffing. Double composite fin with nozzles, offering good power

and energy-saving efficiency. All in all, these fins are perfect for family snorkelling trips and you'll be able to spend hours exploring underwater.

RUBBER FOOT POCKET

ABOVE BLADE FOOT POCKET

TECHNICAL FEATURES

- Comfortable rubber boot
- Large thumb loop
- Push buckles for easy strap length adjustment
- Canopy designed to prevent calf cramps



BLUE/WHITE



BLUE/YELLOW



PURPLE/PINK

FINS WEARABILITY:



PRODUCT	SIZE	CODE	CASE PACK	RRP €
ROCKS KID FINS BLUE/WHITE	S/M	CA262031	3	29.99
ROCKS KID FINS BLUE/WHITE	L/XL	CA262032	3	29.99
ROCKS KID FINS BLUE/YELLOW	S/M	USF020202B	3	29.99
ROCKS KID FINS BLUE/YELLOW	L/XL	USF020204B	3	29.99
ROCKS KID FINS PURPLE/PINK	S/M	USF020302P	3	29.99
ROCKS KID FINS PURPLE/PINK	L/XL	USF020304P	3	29.99



MINI LIGHT

KIDS SNORKELING FINS

Shoe fin with short ruffle made from 100% natural rubber. This material is highly resistant to breakage and degradation by erosion, making it suitable for use by children in the sea and swimming pool. It guarantees flexible, low-fatigue, yet effective snorkelling. The length of the fin and the materials used have been designed to allow the muscles to work perfectly without ever causing painful cramps. The front part of the sail is protected

by a soft elastomer edge to avoid injuring other swimmers. The liner is made entirely from flexible elastomer. It is anatomically shaped to keep the foot in place comfortably, even when swimming for long periods.



ULTRA-FLEXIBLE SOFT MATERIAL



AZURE



YELLOW



PINK

FINS WEARABILITY:

	
BARE FOOT	NEOPRENE SOCKS

PRODUCT	EU SIZE	CODE	CASE PACK	RRP €
MINI LIGHT AZURE	23/24	DP302123	3	34,99
MINI LIGHT AZURE	25/28	DP302125	3	34,99
MINI LIGHT AZURE	29/31	DP302129	3	34,99
MINI LIGHT AZURE	32/33	DP302132	3	34,99
MINI LIGHT AZURE	34/35	DP302134	3	34,99
MINI LIGHT YELLOW	25/28	DP301025	3	34,99
MINI LIGHT YELLOW	29/31	DP301029	3	34,99
MINI LIGHT YELLOW	32/33	DP301032	3	34,99
MINI LIGHT YELLOW	34/35	DP301034	3	34,99
MINI LIGHT PINK	25/28	DP304025	3	34,99
MINI LIGHT PINK	29/31	DP304029	3	34,99
MINI LIGHT PINK	32/33	DP304032	3	34,99
MINI LIGHT PINK	34/35	DP304034	3	34,99



SNORKEL SETS



PRO STAR BAG

PRO STAR FINS + MATRIX MASK + GAMMA SNORKEL

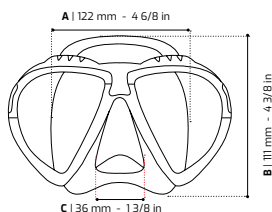

TOTAL LENGTH

SIZE	CM	IN
37/38 (4/5)	60	23.64
39/40 (5.5/6.5)	62.5	24.63
41/42 (7/8)	64.5	25.41
43/44 (8.5/9.5)	66.5	26.2
45/46 (10/11)	68.5	26.99

BLADE LENGTH

SIZE	CM	IN
37/38 (4/5)	50	19.7
39/40 (5.5/6.5)	50.5	19.9
41/42 (7/8)	52	20.49
43/44 (8.5/9.5)	54.5	21.47
45/46 (10/11)	56.5	22.26

MAX WIDTH

SIZE	CM	IN
37/38 (4/5)	20	7.88
39/40 (5.5/6.5)	20.5	8.08
41/42 (7/8)	21	8.27
43/44 (8.5/9.5)	21.5	8.47
45/46 (10/11)	22	8.67

SINGLE FIN WEIGHT

SIZE	CM	IN
37/38 (4/5)	575	1.27
39/40 (5.5/6.5)	615	1.36
41/42 (7/8)	645	1.42
43/44 (8.5/9.5)	710	1.57
45/46 (10/11)	790	1.74

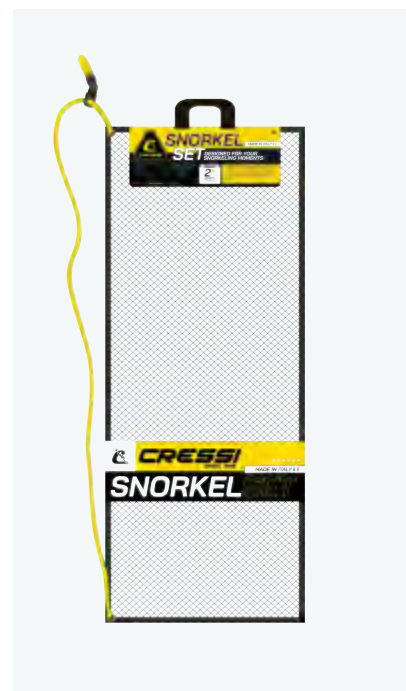

PRODUCT	EU	CODE	*CASE PACK		RRP €
PRO STAR BAG SET BLACK	37/38	BG189537	6		99,99
PRO STAR BAG SET BLACK	39/40	BG189539	6		99,99
PRO STAR BAG SET BLACK	41/42	BG189541	6		99,99
PRO STAR BAG SET BLACK	43/44	BG189543	6		99,99
PRO STAR BAG SET BLACK	45/46	BG189545	6		99,99

/ SNORKEL SETS

PALAU BAG

PALAU FINS + MAREA MASK + GAMMA SNORKEL

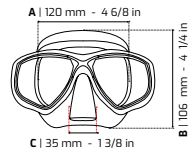

PRODUCT	SIZE	CODE	*CASE PACK		RRP €
PALAU MAREA BAG SET BLUE/AZURE	XS/S (35/38)	CA122635	6		89.99
PALAU MAREA BAG SET BLUE/AZURE	S/M (38/41)	CA122638	6		89.99
PALAU MAREA BAG SET BLUE/AZURE	M/L (41/44)	CA122641	6		89.99
PALAU MAREA BAG SET BLUE/AZURE	L/XL (44/47)	CA122644	6		89.99

PLUMA BAG

PLUMA FINS + PERLA MASK + GAMMA SNORKEL

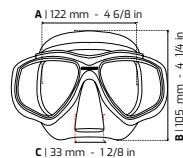

PRODUCT	EU	CODE	*CASE PACK		RRP €
PLUMA BAG SET BLACK	35/36	CA179535	6		74.99
PLUMA BAG SET BLACK	37/38	CA179537	6		74.99
PLUMA BAG SET BLACK	39/40	CA179539	6		74.99
PLUMA BAG SET BLACK	41/42	CA179541	6		74.99
PLUMA BAG SET BLACK	43/44	CA179543	6		74.99
PLUMA BAG SET BLACK	45/46	CA179545	6		74.99



AGUA BAG

AGUA FINS + ONDA MASK + MEXICO SNORKEL

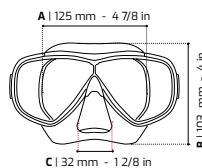

PRODUCT	EU	CODE	*CASE PACK		RRP €
SET AGUA + ONDA + MEXICO BLUE	35/36	XCA312035	6		64,99
SET AGUA + ONDA + MEXICO BLUE	37/38	XCA312037	6		64,99
SET AGUA + ONDA + MEXICO BLUE	39/40	XCA312039	6		64,99
SET AGUA + ONDA + MEXICO BLUE	41/42	XCA312041	6		64,99
SET AGUA + ONDA + MEXICO BLUE	43/44	XCA312043	6		64,99
SET AGUA + ONDA + MEXICO BLUE	45/46	XCA312045	6		64,99

RONDINELLA BAG

RONDINELLA FINS + ONDA MASK + GRINGO SNORKEL

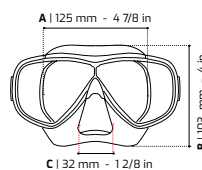

PRODUCT	EU	CODE	*CASE PACK		RRP €
RONDINELLA BAG SET AQUAMARINE	35/36	CA189235	6		54,99
RONDINELLA BAG SET AQUAMARINE	37/38	CA189237	6		54,99
RONDINELLA BAG SET AQUAMARINE	39/40	CA189239	6		54,99
RONDINELLA BAG SET AQUAMARINE	41/42	CA189241	6		54,99
RONDINELLA BAG SET AQUAMARINE	43/44	CA189243	6		54,99
RONDINELLA BAG SET AQUAMARINE	45/46	CA189245	6		54,99
RONDINELLA BAG SET AQUAMARINE	47/48	CA189247	6		54,99

BARON+TONGA SET

NEW 2025

LARGER FIELD OF VISION

IMPROVED COMFORT FOR PROLONGED USE

FINS WITH ADJUSTABLE STRAP
NATURAL BREATHING THROUGH THE NOSE AND MOUTH

NO FOGGING

MASK BARON + FINS TONGA



BLACK/BLACK



BLACK/BLUE

SPECIFICATIONS TECHNIQUES

- Natural breathing through nose and mouth
- Reduced fogging
- Wide field of vision
- Great comfort for prolonged use
- Short fins with adjustable strap

COLOR	SIZE	CODE	RRP €
BLACK/BLACK	S/M	SE015502	99,99
BLACK/BLACK	L/XL	SE015504	99,99
BLACK/BLUE	S/M	SE015202	99,99
BLACK/BLUE	L/XL	SE015204	99,99

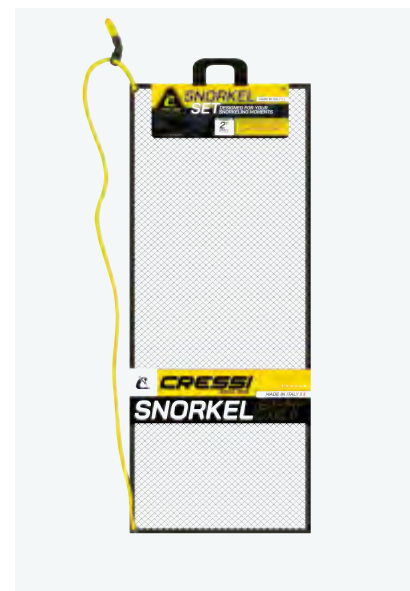

ROCKS DRY SET

NEW 2025

SET SNORKELING JUNIOR



CRESSI JUNIOR



CRESSI KIDS



BLU/WHITE



LILAC/WHITE

COLOR	SIZE	CODE	RRP €
C/SET ROCKS DRY SET BLUE/WHITE	S/M	SE262031	49,99
C/SET ROCKS DRY BLUE/WHITE	L/XL	SE262032	49,99
C/SET ROCKS DRY LILAC/WHITE	S/M	SE264131	49,99
C/SET ROCKS DRY LILAC/WHITE	L/XL	SE264132	49,99

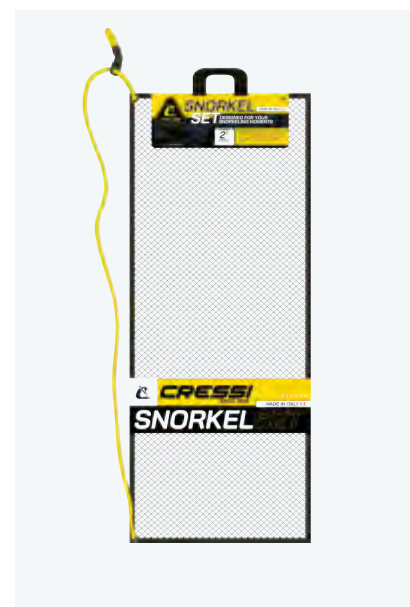

FINS SPARE PARTS

NEW SIZES 2025



EBS STRAP FOR:	SIZE	CODE	*CASE PACK	RRP €
ORIGIN SPRING STEEL STRAP	190MM	CZ251503		49.99
ORIGIN SPRING STEEL STRAP	215MM	CZ251504		49.99
ORIGIN SPRING STEEL STRAP	240MM	CZ251505		49.99
THOR - ARA - PRO LIGHT - FROG	SHORT	BZ150004	-	39.99
THOR - ARA - PRO LIGHT - FROG	REGULAR	BZ150005	-	39.99
REACTION - FROG PLUS	SHORT	BZ150001	-	39.99
REACTION - FROG PLUS	REGULAR	BZ150002	-	39.99
MAUI GREY	-	CZ145550	-	26.99
MAUI BLACK	-	CZ145500	-	26.99
MAUI RED	-	CZ145800	-	26.99
MAUI BLUE	-	CZ145200	-	26.99

STRAP FOR:	CODE	*CASE PACK	RRP €
ALL FINS (EXCEPT PALAU - PALAU SAF)	BZ170002	-	10.5
PALAU - PALAU SAF	BZ170003	-	8.5

BUCKLES FOR:	CODE	*CASE PACK	RRP €
REACTION - FROG PLUS	BZ170016	-	19.99
THOR - ARA - PRO LIGHT	BZ170015	-	19.99
PALAU - PALAU SAF	BZ170004	-	9.99

FINS BAGS



CODE	DLR €	10%	SEASONAL ORDER 20%	RRP €
BZ175003	4,38	3,94	3,50	6,99

CODE	RRP €
BZ175007	12,99



Photo by: Voyages of Agape



Photo by: Voyages of Agape



MASKS

CRESSI

420 UV BLOCK LENSES

These UV420-coated colored lenses protect your retina from harmful High Energy Visible (HEV) light, present on both sunny and cloudy days. The UV420 optical coating provides excellent eye protection and superior sight definition during diving. With 95% UV ray tolerance, these lenses reduce the risk of long-term eye damage and cataracts. Their 92% light transmittance ensures clear, unobstructed vision underwater, enhancing your ability to see vivid colors and fine details.

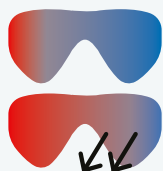

BLU/ORANGE LENSES



• **QUANTUM** MASK BLACK/BLACK 420UV BLOCK BLUE/ORANGE LENS



YELLOW/BLU LENSES

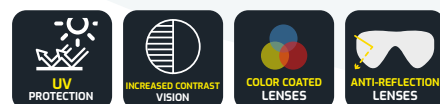

• **PRISMA** MASK BLACK/BLACK UV420 YELLOW/BLUE LENS

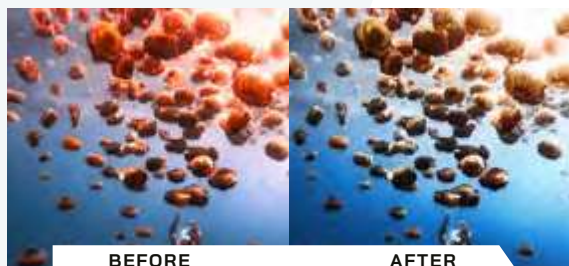

380 UV BLOCK LENSES

These UV 380-coated colored optical coating lenses ensure excellent eye protection with a tolerance of 80% against harmful UV rays. Designed to provide good visual clarity during diving, these lenses offer different light transmittance levels: 86% for yellow lenses and 74% for blue lenses. Ideal for underwater adventures, they enhance eyesight definition and provide a comfortable viewing experience in various lighting conditions.

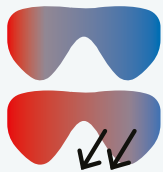

BLU/ORANGE LENSES



• **ZEUS** MASK BLACK/BLACK 380 UV BLOCK BLUE/ORANGE LENS
 • **SF1** MASK BLACK/BLACK 380 UV BLOCK BLUE/ORANGE LENS
 • **Z2** MASK BLACK/BLACK 380 UV BLOCK BLUE/ORANGE LENS
 • **Z2 SMALL** MASK BLACK/BLACK 380 UV BLOCK BLUE/ORANGE LENS
 • **BIG EYES** MASK BLACK/BLACK 380 UV BLOCK BLUE/ORANGE LENS
 • **F1** MASK BLACK/BLACK 380 UV BLOCK BLUE/ORANGE LENS



YELLOW/BLU LENSES



• **Z2** MASK BLACK/BLACK UV BLOCK YELLOW/BLUE LENS

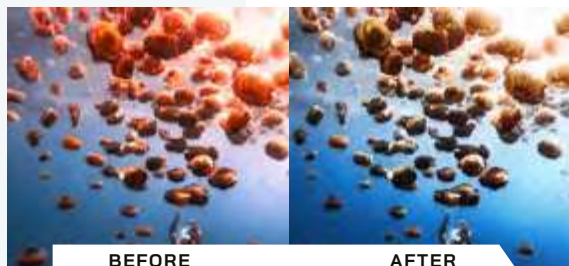

MASK LENS COATING

SPECTRA SILVER LENSES

Experience the advanced semi-reflective lens technology designed for scuba divers and spearfishers. These lenses offer 60% UV ray tolerance and 40-50% light transmittance, providing optimal light adjustment and reducing glare for clear, comfortable vision. Protect your eyes from harmful UV rays and enjoy enhanced visual clarity, making it easier to spot marine life and underwater features. Dive confidently with superior eye protection and sight definition.



- **QUANTUM** MASK BLACK/BLACK SPECTRA MIRRORED LENS
- **CALIBRO** MASK BLACK/BLACK SPECTRA MIRRORED LENS
- **BIG EYES EVOLUTION** MASK BLACK/BLACK SPECTRA MIR. LENSES
- **NANO** MASK BLACK/BLACK SPECTRA MIRRORED LENS
- **FOCUS** MASK BLACK/BLACK SPECTRA MIRRORED LENS

*Ideal for spearfishing



ANTI-FOG COATING LENSES

Cressi's Anti Fog Lens Coating Technology is a new, innovative method to allow the snorkeler or the diver to enjoy the mask right from the beginning.

The new Anti Fog lens is possible thanks to an exclusive coating method based on an invisible film that attaches to the lens during mask production.



- **A1** MASK BLACK/BLUE
- **A1** MASK BLACK/BLACK
- **A1** MASK BLACK/YELLOW



WARNING:
DO NOT ALLOW THE INTERNAL SIDE OF THE LENSES OF THIS PRODUCT TO COME INTO CONTACT WITH CHLORINE

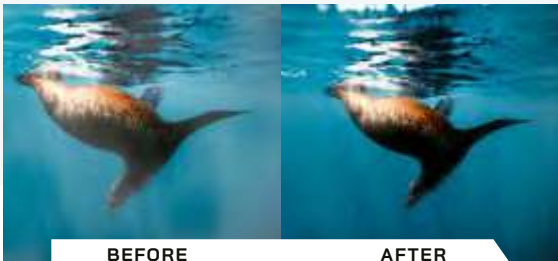

Photo by: Fabio Rolleri

QUANTUM SPECIALIZED

Retailer-Product

- PATENTED ANTI-FOG SYSTEM
- DOUBLE INJECTION TECHNOLOGY
- INCLINED LENSES
- FLEXIBLE BUCKLE WITH MICROMETRIC ADJUSTMENT
- BI-SILICONE STRAP
- TEMPERED GLASS
- 100% HIGH QUALITY SILICONE SKIRT

NEW REVOLUTIONARY ANTI-FOG SYSTEM

The major innovation with the Quantum mask is that as well as offering enhanced downwards vision it avoids the fogging phenomenon through the internal thermoregulation of the warm, damp air exiting the nose. This air is channelled by a system of membranes set in the moulding around the eyes and nose and deviating the flow towards the rubber skirt rather than the lenses. The external part of the skirt features a cooling system composed of two small heat exchangers

that act as radiators. The effect is that the temperature inside mask drops, coming closer to the external temperature and the droplets of humidity are trapped before the air reaches the lenses, preventing them from fogging up. Despite the presence of the small internal membranes deviating the air flow and the external heat exchangers, the body of the Quantum mask is nonetheless compact and represents the most advanced design offered on the underwater vision

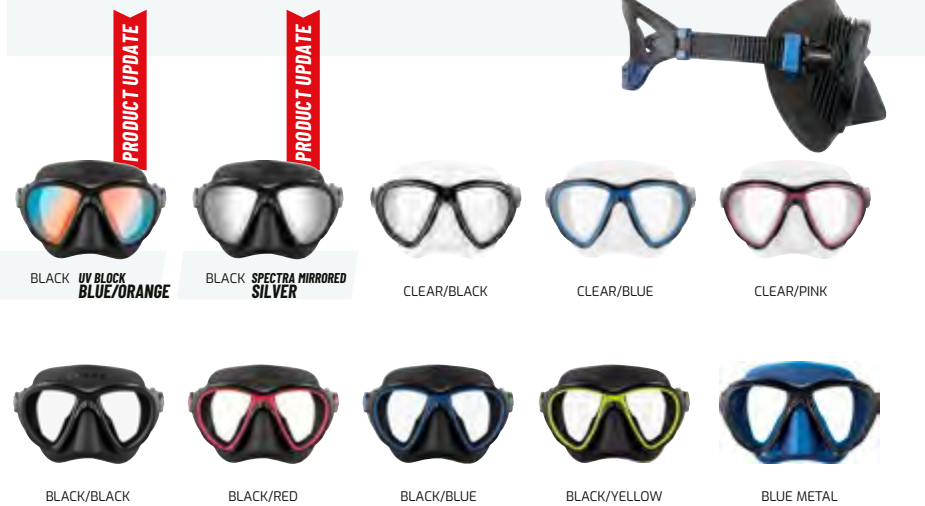
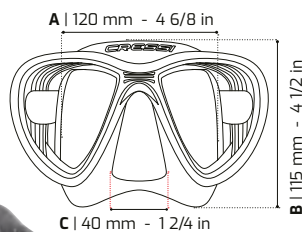

market. The lenses are not treated chemically and it should be remembered that when the mask is new, as is the case with all masks, we advise you to clean the lenses carefully with toothpaste or dishwashing detergent, or simply use Cressi Antifog to clean away all volatile materials and dust that may have collected on the glass. It is also always useful to use saliva as a surfactant before every dive.

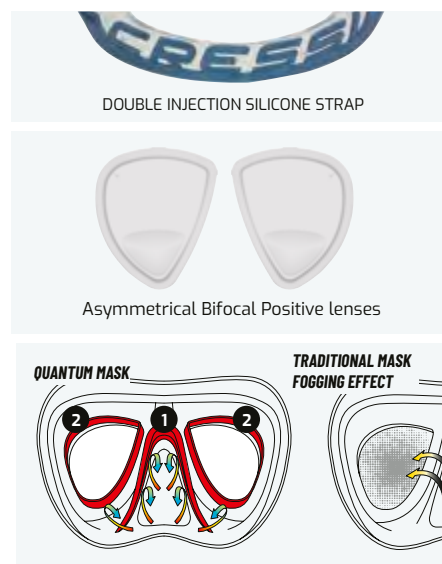

INNER MEMBRANES

A patented membrane surrounding the inner nose pocket (1) and both the inner eyes pockets (2) which acts as a barrier and traps any moisture escaping from the diver's nose involuntarily when breathing through the mouth. The result is that not only is the moisture channelled away from the lenses, thus avoiding the fogging up of them, but it also reduces the need to compensate for pressure.

To further improve the anti-fog effect, Cressi suggests, the first times that the dive mask is used, to spray some anti-fog solution or to apply some saliva on the inside of the lenses and then to rinse them with water.

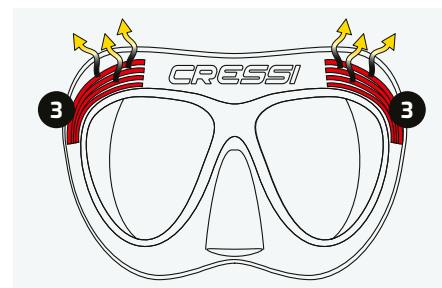

HEAT EXCHANGER

The external part of the skirt features a cooling system composed of two small heat exchangers that act as radiators (3). Thanks to this system, the temperature inside mask drops, coming closer to the external temperature and the droplets of humidity are trapped before the air reaches the lenses, preventing them from fogging up.



PRODUCT	CASE PACK	CODE	RRP €
QUANTUM MASK BLACK/BLACK	6	D5515050	99,99
QUANTUM MASK BLACK/RED	6	D5515080	99,99
QUANTUM MASK BLACK/BLUE	6	D5515020	99,99
QUANTUM MASK BLACK/YELLOW	6	D5515010	99,99
QUANTUM MASK BLUE METAL	6	D5512020	99,99
QUANTUM MASK CLEAR/BLACK	6	D5510050	99,99
QUANTUM MASK CLEAR/BLUE	6	D5510020	99,99
QUANTUM MASK CLEAR/PINK	6	D5510040	99,99
QUANTUM BLACK/BLACK 420 UV BLOCK BLUE/ORANGE	6	D55150509	119,99
QUANTUM BLACK/BLACK SPECTRA MIRROR LENS SILVER	6	D55150508	109,99

NAXOS SPECIALIZED

PATENTED ANTI-FOG SYSTEM

DOUBLE INJECTION TECHNOLOGY

INCLINED LENSES

FLEXIBLE BUCKLE WITH MICROMETRIC ADJUSTMENT

BI-SILICONE STRAP

TEMPERED GLASS

NEW COMPACT ANTI-FOG SYSTEM

The Naxos mask is compact and smaller in size than a classic diving mask, but this unique feature does not reduce the field of vision, and thanks to new internal ribs, it adapts perfectly to any anatomy of the face.

Naxos, like Quantum, not only offers increased downward vision but also avoids the phenomenon of fogging by thermoregulating the warm, moist air escaping from the nose inside the mask. This is channelled by a system of membranes in the

mould around the eyes and nose, which deflect the flow towards the rubber walls and not towards the glass. On the outside of the walls is a cooling system consisting of two small heat exchangers that function like radiators. The effect is that the temperature inside the mask is lowered, bringing it closer to the outside temperature, and that moisture droplets are trapped before the air reaches the glasses, thus preventing them from fogging up.

The lenses are not chemically treated, so it should be remembered that when the mask is new, as is recommended for all masks, it is best to clean the lenses thoroughly with toothpaste, dishwashing detergent or simply use a lighter to burn off all volatiles and impurities deposited on the glass. And it is also always useful before each dive to use saliva as a surfactant.

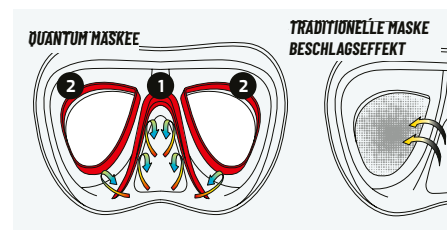
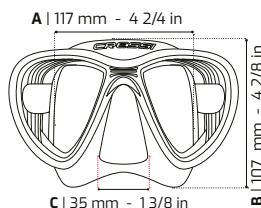

INNER MEMBRANES

A patented membrane surrounding the inner nose pocket (1) and both the inner eyes pockets (2) which acts as a barrier and traps any moisture escaping from the diver's nose involuntarily when breathing through the mouth. The result is that not only is the moisture channelled away from the lenses, thus avoiding the fogging up of them, but it also reduces the need to compensate for pressure.

To further improve the anti-fog effect, Cressi suggests, the first times that the dive mask is used, to spray some anti-fog solution or to apply some saliva on the inside of the lenses and then to rinse them with water.



HEAT EXCHANGER

The external part of the skirt features a cooling system composed of two small heat exchangers that act as radiators (3). Thanks to this system, the temperature inside mask drops, coming closer to the external temperature and the droplets of humidity are trapped before the air reaches the lenses, preventing them from fogging up.



PRODUCT	*CASE PACK	CODE	RRP €
NAXOS BLACK/BLACK	6	D5535050	99,99
NAXOS BLACK/YELLOW	6	D5535010	99,99
NAXOS BLACK/BLUE	6	D5535020	99,99
NAXOS CLEAR/BLUE	6	D5530020	99,99
NAXOS CLEAR/PINK	6	D5530040	99,99
NAXOS CLEAR/AQUAMARINE	6	D5530025	99,99

PRISMA



SPECIALIZED
Retailer-Product

NEW 2025

FLEXIBLE BUCKLE WITH MICROMETRIC ADJUSTMENT

POSITIVE AND NEGATIVE LENSES

100% HIGH QUALITY SILICONE SKIRT

PATENTED ANTI-FOG SYSTEM

NEW REVOLUTIONARY ANTI-FOG SYSTEM SIMMETRIC OPTICAL MASK

The Prisma is much more than a mask; it is a reliable companion for exploring the underwater world in full clarity. The Prisma is equipped with the Cressi patented FOG-STOP system, which drastically reduces fogging through the internal thermoregulation of the warm, damp air exiting the nose. The external part of the skirt additionally features a cooling system made of soft heat exchangers that act as radiators. This effect drops the temperature inside the mask, bringing it closer

to the external temperature, and traps the droplets of humidity before the air reaches the lenses, preventing fogging. What makes the Prisma additionally unique is its ease of adjustment: The micro-adjustment buckle is connected to a soft connection point at the frame, making it easy and smooth to adjust the strap tension without any skirt deformation, which often causes water ingress. Thanks to the combination of two different frame materials and

Cressi's innovative patented soft skirt construction, the mask folds easily to fit in your BCD or cargo pocket.

The Prisma offers the possibility to fit optical lenses for both negative and positive correction, allowing anyone to fully enjoy the wonders of the underwater world without compromising vision.

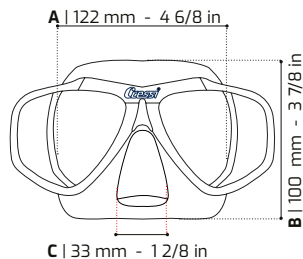

OPTICAL LENSES

Possibility of mounting optical lenses
CORRECTION -1.0 > -8.00 or +1.0 > +3.0

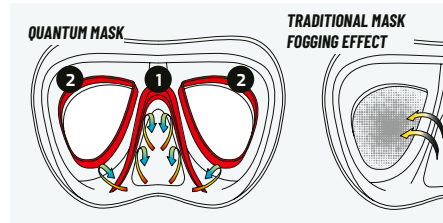

INNER MEMBRANES

A patented membrane surrounding the inner nose pocket (1) and both the inner eyes pockets (2) which acts as a barrier and traps any moisture escaping from the diver's nose involuntarily when breathing through the mouth. The result is that not only is the moisture channeled away from the lenses, thus avoiding the fogging up of them, but it also reduces the need to compensate for pressure.

To further improve the anti-fog effect, Cressi suggests, the first times that the dive mask is used, to spray some anti-fog solution or to apply some saliva on the inside of the lenses and then to rinse them with water.



HEAT EXCHANGER

The external part of the skirt features a cooling system composed of two small heat exchangers that act as radiators (3). Thanks to this system, the temperature inside mask drops, coming closer to the external temperature and the droplets of humidity are trapped before the air reaches the lenses, preventing them from fogging up.



PRODUCT	*CASE PACK	CODE	RRP €
PRISMA MASK BLACK/BLACK UV 420 YELLOW/BLU LENS	6	D55450508	119,99
PRISMA MASK BLACK/BLUE	6	D5545020	99,99
PRISMA MASK BLACK/BLACK	6	D5545050	99,99
PRISMA MASK BLACK/RED	6	D5545080	99,99
PRISMA MASK BLACK/YELLOW	6	D5545010	99,99
PRISMA MASK CLEAR/AQUAMARINE	6	D5540026	99,99
PRISMA MASK CLEAR/PINK	6	D5540040	99,99
PRISMA MASK CLEAR/WHITE	6	D5540030	99,99



ZEUS

NEW COLOR 2025

U.S. PAT 6272693 B1

DOUBLE INJECTION TECHNOLOGY

IDF-TECHNOLOGY INTEGRATED DUAL FRAME

INCLINED LENSES

FLEXIBLE BUCKLE

TEMPERED GLASS

100% HIGH QUALITY SILICONE SKIRT

FOG REDUCER SYSTEM

Zeus is the perfect mask for diving. This mask has a particular tapered structure deriving directly from the highly popular Nano-mask patent. The same IDF-INTEGRATED DUAL FRAME TECHNOLOGY SYSTEM allows you to join the silicone skirt to the lens frame without major interruptions of the

curvature continuity. The result is a mask with an extremely hydrodynamic shape and, visibility being equal, a significantly smaller size. The field of view obtained is particularly wide, laterally and in the lower zone. Thanks to its matte coating the mask's components all match, enhancing the underwater

experience since it prevents reflections in the water that may disturb marine life. The new micrometric adjustable buckles with a larger button allow a more easily regulation also wearing dive gloves. The new strap is made of two different silicone colors.



PRODUCT UPDATE



FOG REDUCER SYSTEM

INNER NOSE POCKET - NEW PATENT PENDING

A patented membrane surrounding the inner nose pocket which acts as a barrier and traps any moisture escaping from the diver's nose involuntarily when breathing through the mouth. The result is that not only is the moisture channeled away from the lenses, thus avoiding the fogging up of them, but it also reduces the need to compensate for pressure.

To further improve the anti-fog effect, Cressi suggests, the first times that the dive mask is used, to spray some anti-fog solution or to apply some saliva on the inside of the lenses and then to rinse them with water.

TRADITIONAL MASK

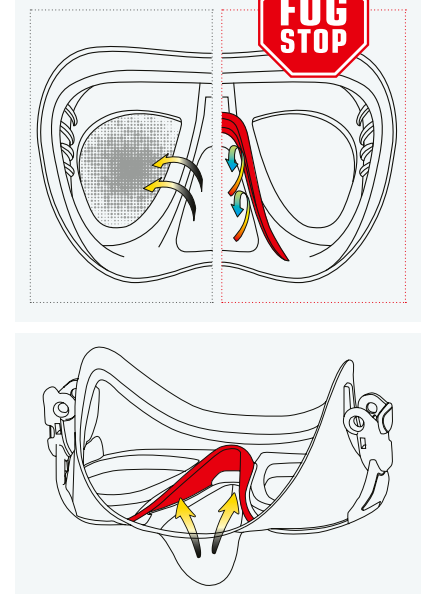

DOUBLE INJECTION SILICONE STRAP



PRODUCT	CASE PACK	CODE	RRP €
ZEUS MASK BLACK 380 UV BLOCK BLUE/ORANGE LENS	6	DS4750509	109,99
ZEUS MASK DARK/GOLD	6	DS475009	89,99
ZEUS MASK BLUE METAL	6	DS475550	89,99
ZEUS MASK BLACK/FRAME BLACK	6	DS475050	89,99
ZEUS MASK GREY	6	DS475150	89,99
ZEUS MASK BLACK/FRAME RED	6	DS475058	89,99
ZEUS MASK BLACK/FRAME SILVER	6	DS475051	89,99
ZEUS MASK CLEAR BLUE METAL	6	DS470020	89,99
ZEUS MASK CLEAR PINK	6	DS470040	89,99
ZEUS MASK CLEAR BLACK	6	DS470050	89,99
ZEUS MASK CLEAR RED	6	DS470058	89,99

SF1 NEW COLOR 2025

SQUARED FRAMELESS DIVE MASK

This frameless single glass mask is made of trendy shiny silicone and has a very small internal volume. Rigorous and squared design suitable even for demanding divers.

Fits most face shapes. Buckle with micrometric adjustment system. Supplied in a sturdy protective box.

- HIGH QUALITY HYPOALLERGENIC SILICONE
- SOFT NOSE POCKET
- 100% HIGH QUALITY SILICONE SKIRT
- TEMPERED GLASS
- FRAMELESS TECHNOLOGY CRESSI
- MICROMETRIC ADJUSTABLE BUCKLE

TECHNICAL FEATURES

- Ultra low-volume, single lens design for excellent field-of-view
- Silicone skirt bonds directly to the lens for lower weight and reduced drag
- Quickly adjustable buckles mounted on the skirt
- High-quality flexible silicone that gently and securely adheres to the face

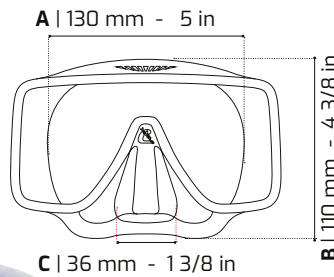

PRODUCT	*CASE PACK	CODE	RRP €
SF1 MASK BLACK 380 UV BLUE/ORANGE LENSES	-	ZDN335051	99,99
SF1 MASK SIL BLUE	-	ZDN331020	79,99
SF1 MASK SIL BLACK	-	ZDN332000	79,99



Z2 **SPECIALIZED**
Retailer-Product

NEW COLOR 2025

FRAMELESS TECHNOLOGY CRESSI

WIDE VIEW

100% HIGH QUALITY SILICONE SKIRT

HIGH QUALITY FRAMELESS MASK

The Cressi Z2 diving mask is made through an advanced molding manufacturing process to achieve a state-of-the-art frameless structure. Z2 provides a wide, distortion-free field of view, allowing divers to enjoy a clear, panoramic view of their surroundings. Made from high-quality silicone, it fits snugly over the face, providing lasting comfort even during

prolonged dives. Its frameless construction makes it remarkably lightweight and easy to handle, allowing for convenient carrying and unparalleled convenience in diving activities. Reliable, high-performance and comfortable, the Cressi Z2 mask is the ideal choice for avid divers who want a high-level diving experience.



TECHNICAL FEATURES

- Frameless structure for superior design
- Wide, distortion-free field of view
- High-quality silicone
- Lasting comfort
- Remarkably lightweight and easy to handle
- Convenient carrying



PRODUCT	CASE PACK	CODE	RRP €
Z2 MASK BLACK/BLACK 380 UV YELLOW/BLUE LENSES	-	DN445059	89.99
Z2 MASK BLACK/BLACK 380 UV BLUE/ORANGE LENSES	-	DN445051	89.99
Z2 MASK SIL BLACK	-	DN445050	69.99
Z2 MASK BLUE METAL/BLUE METAL	-	DN442020	69.99
Z2 MASK SIL GRAPHITE	-	DN445757	69.99
Z2 MASK SIL WHITE	-	DN443030	69.99
Z2 MASK CLEAR	-	DN440000	69.99

Z2 SMALL SPECIALIZED Retailer-Product

NEW COLOR 2025

FOR ADULTS WITH A SMALL FACE

FRAMELESS TECHNOLOGY CRESSI

WIDE VIEW

100% HIGH QUALITY SILICONE SKIRT

HIGH QUALITY FRAMELESS MASK

The smaller version of the Z2 mask. Z2 Small diving mask is made through an advanced molding manufacturing process to achieve a state-of-the-art frameless structure. Z2 provides a wide, distortion-free field of view, allowing divers to enjoy a clear, panoramic view of their surroundings. Made from high-quality silicone, it fits snugly over the face,

providing lasting comfort even during prolonged dives. Its frameless construction makes it remarkably lightweight and easy to handle, allowing for convenient carrying and unparalleled convenience in diving activities. Reliable, high-performance and comfortable, the Cressi Z2 mask is the ideal choice for avid divers who want a high-level diving experience.

TECHNICAL FEATURES

- Frameless structure for superior design
- Wide, distortion-free field of view
- High-quality silicone
- Lasting comfort
- Remarkably lightweight and easy to handle
- Convenient carrying

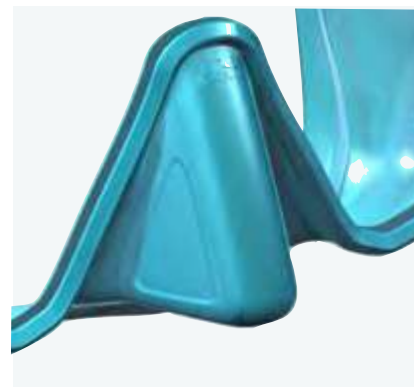

PRODUCT	*CASE PACK	CODE	RRP €
Z2 SMALL MASK PINK FLUO/PINK FLUO	-	DN454242	69,99
Z2 SMALL MASK YELLOW	-	DN451010	69,99
Z2 SMALL MASK BLACK/BLACK 380 UV BLUE/ORANGE LENSES	-	DN455051	89,99
Z2 SMALL MASK SIL BLACK	-	DN455050	69,99
Z2 SMALL MASK BLUE METAL/BLUE METAL	-	DN452020	69,99
Z2 SMALL MASK SIL TURQUOISE	-	DN452828	69,99
Z2 SMALL MASK SIL WHITE	-	DN453030	69,99

BIG EYES EVOLUTION CRYSTAL

WITH CRYSTAL SILICONE SKIRT

- TEMPERED GLASS
- U.S. PAT 6272693 B1
- DOUBLE INJECTION TECHNOLOGY
- INCLINED LENSES
- FLEXIBLE BUCKLE
- MICROMETRIC ADJUSTABLE BUCKLE
- 100% HIGH QUALITY SILICONE SKIRT

The ultimate in comfort and performance, the Big Eyes Evolution Crystal combines the best of Cressi technologies. Raked lenses, with Cressi's inverted tear-drop shape, are placed close to the eyes for an exceptional field of view, and the Crystal Silicone

skirt delivers excellent light transmission while resisting discoloration and fogging. The Crystal Silicone skirt also seals gently against the skin with a very open angle that accommodates a wide range of facial shapes.

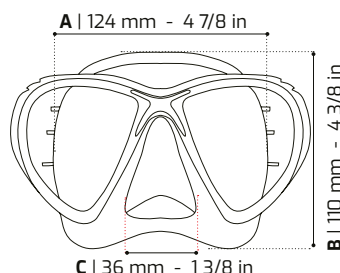

TECHNICAL FEATURES

- Raked lenses provide excellent field-of-view
- Inverted tear-drop lenses improve downward visibility for managing BC-mounted gear
- Low internal volume allows for effortless clearing
- Crystal Silicone resists aging and prevents skirt discoloration and fogging
- Ribbed skirt design provides support where needed for a soft, flexible fit
- Micrometric adjustable buckles allow precise headband adjustments
- Swiveling buckles connect to flexible, indestructible elastomer tabs for total durability and comfort
- Accepts optical lenses

OPTICAL LENSES

Possibility of mounting optical lenses
CORRECTION +1.0 > +3.0 / -1.00 > -6.00



THE SILICONE REVOLUTION crystal®

CRYSTAL silicone® is an exclusive CRESSI material that revolutionizes swim mask skirt clarity.

It offers incredibly clear vision and features long-lasting advanced technology components within the pure silicone skirt which prevents premature discoloration, reduces fogging, and guarantees many years of CRYSTAL clear viewing.



PRODUCT	CASE PACK	CODE	RRP €
BIG EYES EVOLUTION MASK SIL CRYSTAL/FRAME YELLOW	6	D5340010	69,99
BIG EYES EVOLUTION MASK SIL CRYSTAL/FRAME BLUE BLACK	6	D5340025	69,99
BIG EYES EVOLUTION MASK SIL CRYSTAL/FRAME PINK	6	D5340040	69,99
BIG EYES EVOLUTION MASK SIL CRYSTAL/FRAME BLACK	6	D5340060	69,99
BIG EYES EVOLUTION MASK SIL CRYSTAL/FRAME BLUE	6	D5340062	69,99

BIG EYES EVOLUTION

U.S. PAT 6272693 B1 | DOUBLE INJECTION TECHNOLOGY | TEMPERED GLASS | FLEXIBLE BUCKLE | MICROMETRIC ADJUSTABLE BUCKLE | INCLINED LENSES | 100% HIGH QUALITY SILICONE SKIRT

OUTSTANDING FIELD OF VIEW

The Big Eyes Evolution's signature inverted tear-drop lenses are raked inward and provide outstanding field of view with very low internal volume. A redesigned skirt now uses internal ribs

to provide the ultimate in fit and support. Fully flexible, easy adjust buckles are attached using Cressi's double injection molding technology for both comfort and extreme durability.

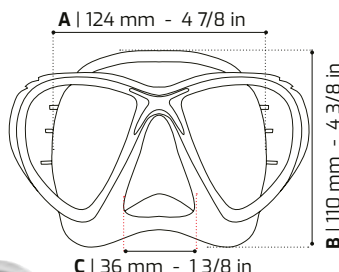

PRODUCT	CASE PACK	CODE	RRP €
BIG EYES EVOLUTION MASK SIL CLEAR/FRAME RED	6	D5336080	59,99
BIG EYES EVOLUTION MASK SIL CLEAR/FRAME YELLOW	6	D5336010	59,99
BIG EYES EVOLUTION MASK SIL CLEAR/FRAME BLUE BLACK	6	D5336020	59,99
BIG EYES EVOLUTION MASK SIL CLEAR/FRAME PINK	6	D5336040	59,99
BIG EYES EVOLUTION MASK SIL CLEAR/FRAME BLACK	6	D5336060	59,99
BIG EYES EVOLUTION MASK SIL BLACK/FRAME BLACK	6	D5336550	59,99
BIG EYES EVOLUTION MASK SIL DARK BLUE	6	D5336520	59,99
BIG EYES EVOLUTION MASK SIL DARK YELLOW	6	D5336510	59,99
BIG EYES EVOLUTION MASK BLACK/BLACK SPECTRA MIR.	6	D5336950	79,99

TECHNICAL FEATURES

- Raked lenses provide excellent field-of-view
- Inverted tear-drop lenses improve downward visibility for managing BC-mounted gear
- Low internal volume allows for effortless clearing
- Dual-density silicone skirt flexes for a perfect seal along the face and full support around the frame
- Ribbed facial skirt provides support where needed for a soft, flexible fit
- Micrometric adjustable buckles allow precise headband adjustments
- Swiveling buckles connect to flexible, indestructible elastomer tabs for total durability and comfort.
- Accepts optical lenses

OPTICAL LENSES

Possibility of mounting optical lenses
CORRECTION +1.0 > +3.0 / -1.00 > -6.00

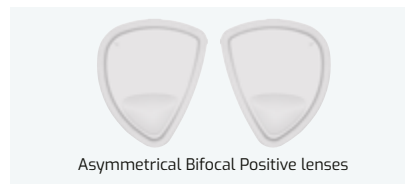

A1  **SPECIALIZED**
Retailer-Product

WIDE VIEW ANTI-FOG MASK

The A1 has been designed with an attractive style, it boasting high performance for scuba diving and freediving. It features a single-lens, tempered glass lens with special treatment, making it completely anti-fog!
The lenses are inclined and they have an inverted teardrop shape, increasing the downwards visibility. This allows better control of the scuba diving equipment.

The skirt and the strap are made of a soft silicone ensuring a high-adaptation fitting most of the different face shapes. The top of the internal skirt features a double edge that increases drastically the sealing.
The buckles are connected to the frame with a soft and elastic flap, not only for a flexible fit but also to reduce drag and the risk of break.

PATENTED ANTI-FOG SYSTEM | 100% HIGH QUALITY SILICONE SKIRT | INCLINED LENSES

TECHNICAL FEATURES

- Attractive style with high-performance capabilities
- Anti-fog tempered glass lens
- Increased downwards visibility for better equipment control
- Soft silicone skirt
- High adaptability
- Reduced drag and risk of breakage.

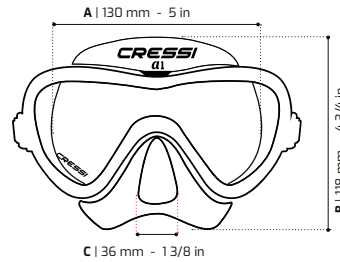

CLEAR VIEW ON EVERY DIVE INCLUDING THE FIRST



Cressi's Anti Fog Lens Coating Technology is a new, innovative method to allow the snorkeler or the diver to enjoy the mask right from the beginning. The new Anti Fog lens is possible thanks to an exclusive coating method based on an invisible film that attaches to the lens during mask production.

WARNING:
DO NOT ALLOW THE INTERNAL SIDE OF THE LENSES OF THIS PRODUCT TO COME INTO CONTACT WITH CHLORINE

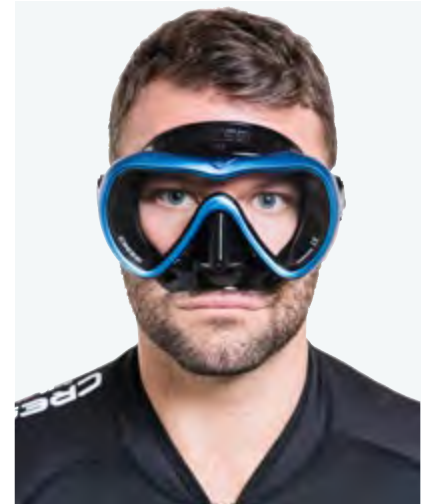

PRODUCT	CASE PACK	CODE	RRP €
A1 MASK BLACK/GRAPHITE	-	XDN400057	119,99
A1 MASK BLACK/YELLOW	-	DN435010	119,99
A1 MASK BLACK/BLUE	-	XDN400013	119,99

PENTA +

UNPRECEDENTED TOTAL VISION

U.S. PAT
6272693 B1

DOUBLE INJECTION
TECHNOLOGY

TEMPERED
GLASS

INCLINED
LENSES

100% HIGH QUALITY
SILICONE SKIRT

The Penta+ is the restyling of the popular Penta mask. It has four lenses and also introduces to this sector all the exceptional characteristics of the Matrix and the Lince. The Cressi patented system of raked lenses with an "inverted drop" shape offers incredible downward visibility, ideal for having under control the scuba diving equipment. The

clear side windows are made of scratch-resistant material, more strong than glass or polycarbonate. Thanks to them, the mask offers unprecedented lateral visibility and great luminosity for total vision with no compromises. The skirt and the strap are made of hypoallergenic silicone, a very soft material compared to the low-quality PVC,

that ensures a perfect seal and comfort. The buckles are embedded in the frame to offer instant adjustment of the strap length, even with one hand. It offers a very low internal volume, a record weight of only 175 g (6.2 oz).

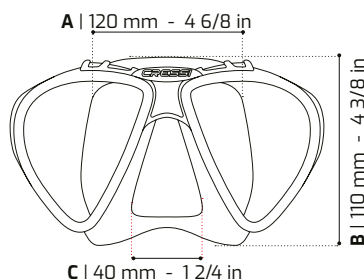

TECHNICAL FEATURES

- Type: four lens mask
- Front lenses: inverted teardrop design to ensure maximum visibility, made of tempered glass
- Strap buckles: pressure, with instant adjustment
- Very low internal volume
- Weight: 175 g (6.2 oz)



PRODUCT	*CASE PACK	CODE	RRP €
PENTA+ MASK BLACK/BLUE	6	D5495020	79,99
PENTA+ MASK BLACK/BLACK	6	D5495050	79,99
PENTA + MASK CLEAR/BLUE	6	D5490020	79,99

AIR NEW COLOR 2025

U.S. PAT
6272693 B1

DOUBLE INJECTION
TECHNOLOGY

IDF-TECHNOLOGY
INTEGRATED DUAL FRAME

TEMPERED
GLASS

MICROMETRIC
ADJUSTABLE BUCKLE

FLEXIBLE
BUCKLE

INCLINED
LENSES

100% HIGH QUALITY
SILICONE SKIRT

NEW IDF TECHNOLOGY INTEGRATED DUAL FRAME

This mask has a particular tapered structure deriving directly from the highly popular Nano-mask patent. THE DUAL INTEGRATED FRAME TECHNOLOGY SYSTEM allows you to join the silicone skirt to the lens frame without major interruptions of the curvature continuity.

The result is a mask with an extremely hydrodynamic shape and, visibility being equal, a significantly smaller size. The field of view obtained is particularly wide, laterally and in the lower zone. The skirt, in the front part, has a structural silicone insert which increases the sealing ability

of the mask and creates an exceptionally pleasant chromatic play. Micrometer adjustable buckles.

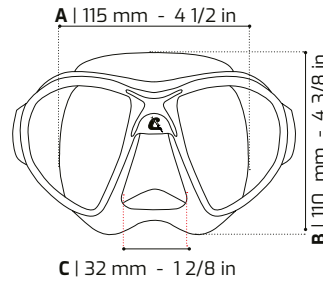

PRODUCT	°CASE PACK	CODE	RRP €
AIR MASK SIL CLEAR ASSORTED	6	DS400099	59.99
AIR MASK SIL CLEAR/FRAME BLACK YELLOW	6	DS400010	59.99
AIR MASK SIL BLUE METAL	6	DS405550	59.99
AIR MASK SIL BLACK/FRAME BLACK YELLOW	6	DS405010	59.99
AIR MASK SIL BLACK/FRAME WHITE	6	DS405060	59.99



ATOM

ATOM



**ULTRA LOW-VOLUME MASK,
DESIGNED TO FACILITATE
THE EQUALISATION PROCESS <<**

CARLOS GODOY
Technical Manager Soft Goods



MADE IN ITALY



WHY BUY IT?

Atom is a 'frameless' mask made in Italy from certified hypoallergenic silicone, the same used in medical devices. Silicone adhesion is achieved without the use of glue or primer (surface adhesion promoter), "we do not use any chemical additives". The glasses are protected during the process to prevent the deposit of volatiles that are annoying to remove and cause intense fogging.

WHAT MAKES IT DIFFERENT?

The structure of the mask is made of two materials. The first rigid material develops around the lenses and takes a curved shape that wraps around the nose. This particular shape allows us to bring the lenses closer to the eyes, reducing their internal volume and at the same time giving the lenses a solid and stable structure. With the second material, liquid silicone, we are going to complete the skirt that adheres to the face. This way, the facepiece rests on the face for almost the entire contact surface. The internal volume is the smallest ever. You often see internal volume values in magazines. Actually, the internal air volume depends on each person's anatomy. What I can confirm is that it is almost half that of the Nano mask. Using the parameters of an average occidental person, the programme gives me 50-60 ml.

WHERE IS THE INNOVATION?

On either side of the nose you will find two very pronounced cavities. Inside, their thickness is reduced to almost zero. This will allow us to compensate without moving the upper lip of the face, preventing the entry of unwanted water. Finally, its field of vision is very wide thanks to the shape and extreme proximity of the lenses to the eyes.





LOW INNER VOLUME MASK



MADE IN ITALY

ATOM SPECIALIZED

Retailer-Product

ULTRA LOW VOLUME MASK

Atom is a radical mask, with incredible low internal volume, thought and built for free-diving. It is a frameless mask. Construction material has been reduced to the minimum. Inside the silicon facial a stiff core is co-stamped with the two lenses, giving just the right rigidity to the mask. This semi-rigid core substitutes the usual external plastic frame and allowed us to reduce the internal volume of the mask in an unseen way until today. Another feature of Atom is the ergonomic shape

of the nose. Two small cavities, carved by the nostrils, facilitate the action of compensation. This makes the mask extremely stable during the dive. Atom will not move when you compensate pushing Atom is the perfect mask for the expert free-diver and spear-fisher, who wants the maximum performance from its gear.

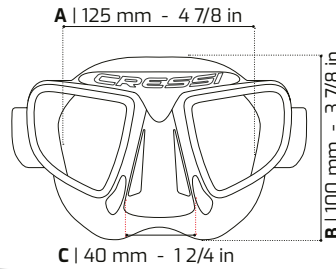

- FLEXIBLE BUCKLE
- MICROMETRIC ADJUSTABLE BUCKLE
- TEMPERED GLASS
- 100% HIGH QUALITY SILICONE SKIRT
- ULTRA LOW VOLUME
- ERGONOMIC NOSE SHAPE
- EASY COMPENSATION

TECHNICAL FEATURES

- Ultra low-volume mask, designed for facilitate the action of compensation
- Rigid co-stamped stiff core
- Ergonomic shape of the nose
- Ideal for expert free-diver and spear-fisher



PRODUCT	*CASE PACK	CODE		RRP €
ATOM MASK BLUE METAL/BLACK	6	D5522050		69.99
ATOM MASK WHITE/BLACK	6	D5523050		69.99
ATOM MASK BLACK/BLACK	6	D5525050		69.99
ATOM MASK GREEN/BLACK	6	D5527550		69.99

CALIBRO

FOG REDUCER SYSTEM

Cressi's next generation diving masks are all equipped with the IDF-INTEGRATED DUAL FRAME TECHNOLOGY which offers exceptional field of view, and the new Calibro is no exception. The mask is designed so that the integrated face and frame allow for an extremely hydrodynamic and compact shape and a particularly wide lens, maintaining the mask extremely close to the face. Cressi's Calibro combines minimal internal volume with a phenomenal field of view due to the raked angle of the frame. The buckles are, as always,

directly integrated into the rigid skirt through a solid but flexible rubber attachment that allows you to adjust and place the mouthpiece without shifting the mask. Thanks to its matte coating the mask's components all match, enhancing the underwater experience since it prevents reflections in the water that may disturb marine life. Calibro is the perfect mask also for free-diving since it is designed to provide the diver with a feeling of total freedom and comfort.

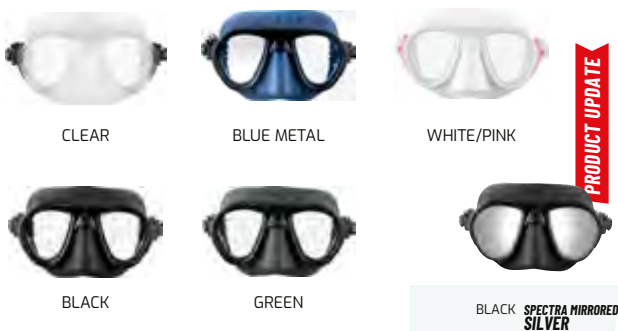

PRODUCT	CASE PACK	CODE	RRP €
CALIBRO MASK SIL CLEAR	6	DS426000	59,99
CALIBRO MASK SIL BLUE METAL	6	DS425550	59,99
CALIBRO MASK SIL WHITE/FRAME PINK	6	DS424030	59,99
CALIBRO MASK SIL BLACK/FRAME BLACK	6	DS425050	59,99
CALIBRO MASK SIL GREEN/FRAME GREEN	6	DS429850	59,99
CALIBRO MASK BLACK/SPECTRA MIRRORED LENS SILVER	6	DS426050	79,99

FOG REDUCER SYSTEM

INNER NOSE POCKET - NEW PATENT PENDING

A patented membrane surrounding the inner nose pocket which acts as a barrier and traps any moisture escaping from the diver's nose involuntarily when breathing through the mouth. The result is that not only is the moisture channeled away from the lenses, thus avoiding the fogging up of them, but it also reduces the need to compensate for pressure.

To further improve the anti-fog effect, Cressi suggests, the first times that the dive mask is used, to spray some anti-fog solution or to apply some saliva on the inside of the lenses and then to rinse them with water.

TRADITIONAL MASK

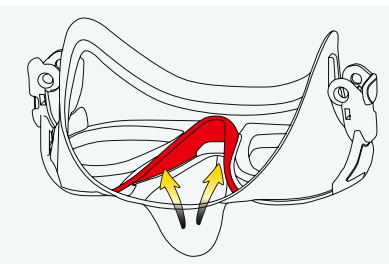
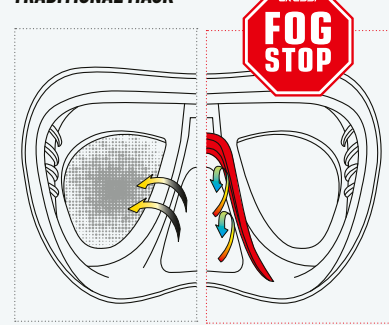

NANO

- U.S. PAT 6272693 B1
- ULTRA LOW VOLUME
- INTEGRATED DUAL FRAME
- TEMPERED GLASS
- MICROMETRIC ADJUSTABLE BUCKLE
- FLEXIBLE BUCKLE
- 100% HIGH QUALITY SILICONE SKIRT

NEW IDF TECHNOLOGY INTEGRATED DUAL FRAME

Mask for advanced freediving and spearfishing, designed to offer an extremely hydrodynamic and compact shape to help divers cut through the water and aid movements in small spaces.

The internal volume is minimal and does not require intentional equalizing. The swiveling buckles feature micrometric regulation. Angled tempered glass lenses. Anatomical strap.

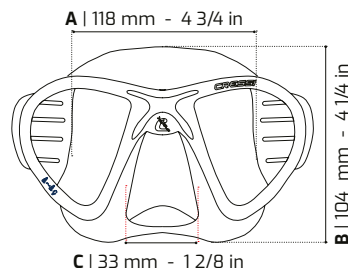

PRODUCT	CASE PACK	CODE	RRP €
NANO MASK SIL CRYSTAL/FRAME BLUE	6	DS360020	79.99
NANO MASK SIL CRYSTAL/FRAME YELLOW	6	DS360010	79.99
NANO MASK SIL CRYSTAL/FRAME PINK	6	DS360040	79.99
NANO MASK SIL CRYSTAL/FRAME LILAC	6	DS360041	79.99
NANO MASK SIL BLACK/FRAME BLACK	6	DS365050	69.99
NANO MASK SIL GREEN/FRAME GREEN	6	DS369850	69.99
NANO MASK BLUE (SILVER/FRAME BLACK)	6	DS365550	69.99
NANO MASK BLACK/SPECTRA MIRRORED LENS SILVER	6	DS366050	89.99

TECHNICAL FEATURES

- Extremely hydrodynamic and compact design
- Internal volume just 85 cm³
- Reduced lens-face distance
- Angle lenses and slender structure optimize visibility
- Swivel buckles with micrometric adjustment
- Lenses in tempered glass
- Anatomical strap

THE SILICONE REVOLUTION

crystal[®]

CRYSTAL silicone[®] is an exclusive CRESSI material that revolutionizes swim mask skirt clarity.



MATRIX

EXCELLENT FIELD-OF-VIEW

The compact twin-lens Matrix takes the basic design concepts of the Big Eyes Evolution and pushes them to a new level of performance. More pronounced inverted tear-drop shaped lenses,

raked inward to sit even closer to the eyes, and a more compact build overall make the Matrix an ideal choice for divers and free divers looking for the biggest view in the smallest package.

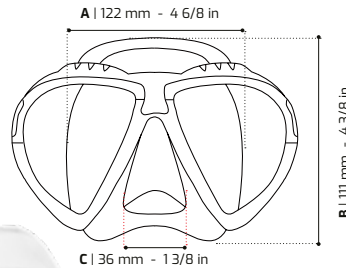

TECHNICAL FEATURES

- Raked lenses provide excellent field-of-view
- Extremely low internal volume on par with the best free diving masks
- Silicone skirt shaped to provide a wide sealing surface for a leak-free fit
- Micrometric adjustable buckles allow precise headband adjustments
- Overmolded frame is easy to grip
- Inverted tear-drop lenses improve downward visibility for managing BC-mounted gear



PRODUCT	*CASE PACK	CODE	RRP €
MATRIX MASK SIL CLEAR/FRAME BLUE	6	DS301020	54,99
MATRIX MASK SIL CLEAR/FRAME YELLOW	6	DS301010	54,99
MATRIX MASK SIL CLEAR/FRAME BLACK	6	DS301060	54,99
MATRIX MASK SIL CLEAR/FRAME AQUAMARINE	6	DS301063	54,99
MATRIX MASK SIL BLACK/FRAME BLACK	6	DS302050	54,99
MATRIX MASK SIL BLACK/FRAME RED	6	JDS300058	54,99



LINCE

ULTRA COMPACT MASK

A trimmed down version of the Matrix, the Lince is a perfect fit for many younger divers or those with narrower faces. The extremely low internal volume makes it comfortable to wear and effortless to

clear. Divers and snorkelers alike will appreciate the exceptional field of view offered in this ultra compact mask.

U.S. PAT
6272693 B1

INCLINED
LENSES

MICROMETRIC
ADJUSTABLE BUCKLE

TEMPERED
GLASS

100% HIGH QUALITY
SILICONE SKIRT



CLEAR/PINK



CLEAR/AQUAMARINE



CLEAR/YELLOW



CLEAR ASSORTED



BLACK



TECHNICAL FEATURES

- Drastically reduced internal volume
- Instant-adjust pressure-strap buckles
- Skirt designed for women and children
- Excellent visibility and comfort
- For all underwater activities

PRODUCT	*CASE PACK	CODE	RRP €
LINCE MASK SIL/FRAME ASSORTED	6	DS311099	54,99
LINCE MASK SIL CLEAR/FRAME YELLOW	6	DS311010	54,99
LINCE MASK SIL CLEAR/FRAME PINK	6	DS311040	54,99
LINCE MASK SIL CLEAR/FRAME AQUAMARINE	6	DS311063	54,99
LINCE MASK SIL BLACK/FRAME BLACK	6	DS312050	54,99

BIG EYES NEW COLOR 2025

EXCELLENT FIELD-OF-VIEW

The mask that began a revolution remains one of the most duplicated designs today. Its inverted tear-drop lens shape and raked lenses provide 30% greater field of view than typical twin-

lens masks. The high-grade silicone skirt's unique shape positions the lenses comfortably close to the eyes and provides an excellent seal.

U.S. PAT
6272693 B1

INCLINED
LENSES

MICROMETRIC
ADJUSTABLE BUCKLE

TEMPERED
GLASS

100% HIGH QUALITY
SILICONE SKIRT

TECHNICAL FEATURES

- Raked lenses provide excellent field-of-view
- Inverted tear-drop lenses improve downward visibility for managing BC-mounted gear
- Low internal volume allows for effortless clearing
- High-grade silicone skirt provides a leak-free seal
- Quick-adjust swivel buckles

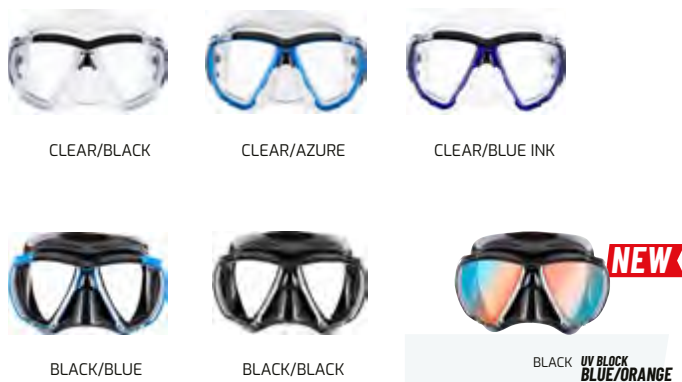
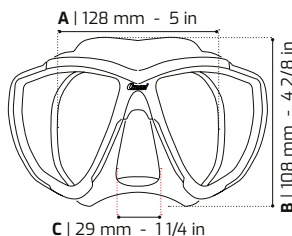

PRODUCT	*CASE PACK	CODE	RRP €
BIG EYES MASK SIL BLACK/FRAME BLACK 380 UV BLOCK BLUE/ORANGE LENSES	6	DS2650501	69.99
BIG EYES MASK SIL CLEAR/FRAME BLACK	6	DS261060	49.99
BIG EYES MASK SIL CLEAR/FRAME AZURE	6	DS261020	49.99
BIG EYES MASK SIL CLEAR/FRAME BLUE INK	6	DS261062	49.99
BIG EYES MASK SIL BLACK/FRAME BLUE	6	DS262020	49.99
BIG EYES MASK SIL BLACK/FRAME BLACK	6	DS262050	49.99



FOCUS NEW COLOR 2025

SIMMETRIC OPTICAL MASK

The ultimate in versatility, this classic mask offers the best fit and performance for the greatest variety of facial shapes. Its low-volume, twin-lens design gives divers and snorkelers a proven

combination of size, fit and durability. Lightweight and easy-to-clear it has swiveling, quick-adjust buckles and accepts corrective lenses. It is also an excellent value.



- EASY ADJUSTABLE BUCKLE
- TEMPERED GLASS
- 100% HIGH QUALITY SILICONE SKIRT

TECHNICAL FEATURES

- Low internal volume allows for effortless clearing
- Lightweight, compact and rugged
- Ideal for travel or as a backup mask
- High-grade silicone skirt provides a leak-free seal
- Quick-adjust swivel buckles prevent binding
- Accepts optical lenses

OPTICAL LENSES

Possibility of mounting optical lenses
CORRECTION -1.0 > -8.00 or +1.0 > +3.0

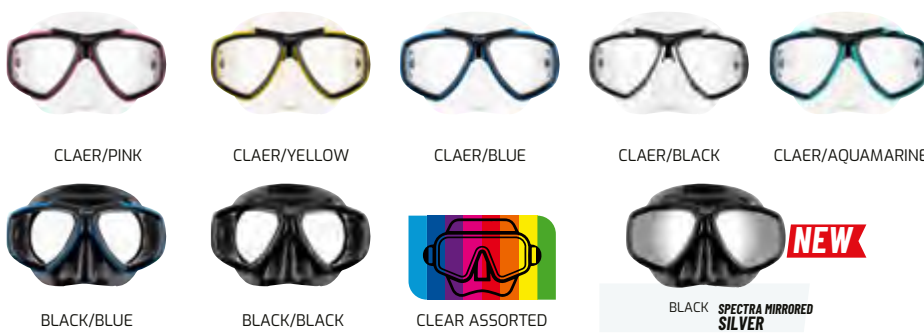
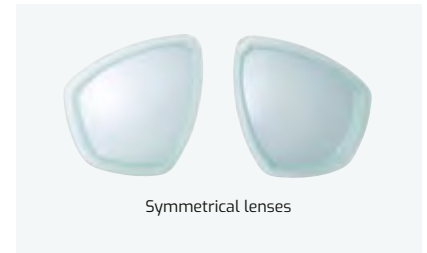

PRODUCT	CASE PACK	CODE	RRP €
FOCUS MASK SIL CLEAR/FRAME ASSORTED	6	D5241099	49,99
FOCUS MASK SIL CLEAR/FRAME PINK	6	D5241040	49,99
FOCUS MASK SIL CLEAR/FRAME YELLOW	6	D5241010	49,99
FOCUS MASK SIL CLEAR/FRAME BLUE	6	D5241020	49,99
FOCUS MASK SIL CLEAR/FRAME BLACK	6	D5241060	49,99
FOCUS MASK SIL CLEAR/FRAME AQUAMARINE	6	D5241063	49,99
FOCUS MASK SIL BLACK/FRAME BLUE	6	D5242020	49,99
FOCUS MASK SIL BLACK/FRAME BLACK	6	D5242050	49,99
FOCUS MASK SIL BLACK/FRAME BLACK SPECTRA MIRRORED LENS SILVER	6	D52450500	69,99



LIBERTY TRISIDE

THREE WINDOWED MASK

3 LENS PANORAMIC DESIGN

TEMPERED GLASS

MICROMETRIC ADJUSTABLE BUCKLE

FLEXIBLE BUCKLE

100% HIGH QUALITY SILICONE SKIRT

The Liberty Triside features a wide mono front lens with 2-sided lenses to ensure a panoramic view without interruption. The result is a mask that allows maximum light and feels as open as the ocean itself. All lenses are tempered glass for the best clarity. The skirt is made in hypoallergenic silicone to

ensure comfort and a perfect seal. It is a breeze to adjust the length of the strap thanks to the two buttons on the buckle, which can also be used while wearing gloves. The frame is colored with a paint effect that makes the mask elegant and beautiful to see, which can be coordinated with your equipment.

TECHNICAL FEATURES

- Three-lens panoramic design for excellent peripheral vision.
- Lightweight, durable polycarbonate frame.
- Soft silicone skirt fits a wide range of face shapes.
- Fast-adjust ratcheting strap buckles.
- Easy-access nose pocket for equalization.
- Lenses made in tempered glass.

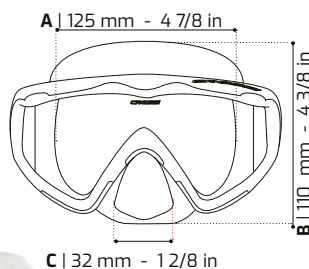

BLACK/SAPPHIRE



BLACK/GRAPHITE



CLEAR/YELLOW/SILVER



CLEAR/BLUE/SILVER



BLACK/RED/SILVER

PRODUCT	CASE PACK	CODE	RRP €
LIBERTY TRISIDE SPE MASK BLACK/SAPPHIRE	-	D5455020	89,99
LIBERTY TRISIDE SPE MASK BLACK/GRAPHITE	-	D5455050	89,99
LIBERTY TRISIDE SPE MASK CLEAR/YELLOW/SILVER	-	D5450015	89,99
LIBERTY TRISIDE SPE MASK CLEAR/BLUE/SILVER	-	D5450025	89,99
LIBERTY TRISIDE SPE MASK BLACK/RED/SILVER	-	D5455058	89,99

F1

FRAMELESS COLORAMA DIVE MASK

Frameless masks are loved by many divers for their low-profile and ability to fold flat for easy carrying, even in a BC pocket. Cressi's frameless design bonds a high-grade silicone skirt directly to a single lens for the ultimate in simplicity.

The low-internal volume allows for effortless clearing and quick-adjust strap buckles are molded directly into the skirt for a flexible fit and reduced drag. It also represents an unbeatable value, with a cost roughly half that of similar masks.

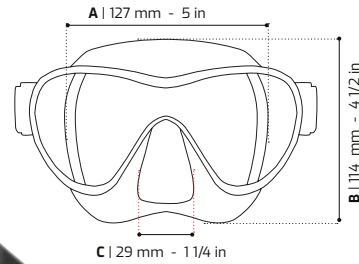

PRODUCT	CASE PACK	CODE	RRP €
F1 MASK SIL BLACK	-	ZDN282000	49.99
F1 MASK SIL CLEAR	-	ZDN281000	49.99
F1 MASK SIL WHITE	-	ZDN283000	49.99
F1 MASK SIL YELLOW	-	ZDN281010	49.99
F1 MASK SIL BLUE	-	ZDN281020	49.99
F1 MASK SIL PINK	-	ZDN284000	49.99
F1 MASK SIL SILVER	-	ZDN281051	49.99
F1 MASK SIL AQUAMARINE	-	ZDN281025	49.99
F1 MASK BLACK 380 UV BLOCK BLUE/ORANGE LENS	-	ZDN282150	69.99

- MICROMETRIC ADJUSTABLE BUCKLE
- TEMPERED GLASS
- 100% HIGH QUALITY SILICONE SKIRT

TECHNICAL FEATURES

- Ultra low-volume, single lens design for excellent field-of-view
- Silicone skirt bonds directly to the lens for lower weight and reduced drag
- Fast-adjust ratcheting strap buckles mounted to skirt
- Supple, high-grade silicone seals gently and securely against the face
- Tempered glass lenses
- Easy-access nose pocket for equalization
- Excellent value



F1 SMALL

NEW COLOR 2025

SMALL FIT MASK

Frameless masks are loved by many divers for their low-profile and ability to fold flat for easy carrying, even in a BC pocket. Cressi's frameless design bonds a high-grade silicone skirt directly to a single lens for the ultimate in simplicity.

The low-internal volume allows for effortless clearing and quick-adjust strap buckles are molded directly into the skirt for a flexible fit and reduced drag. It also represents an unbeatable value, with a cost roughly half that of similar masks.

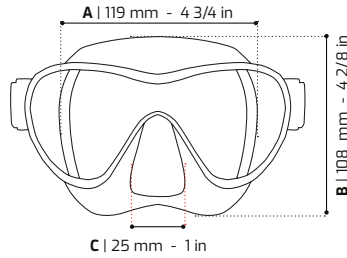

MICROMETRIC ADJUSTABLE BUCKLE TEMPERED GLASS 100% HIGH QUALITY SILICONE SKIRT

TECHNICAL FEATURES

- Ultra low-volume, single lens design for excellent field-of-view
- Silicone skirt bonds directly to the lens for lower weight and reduced drag
- Fast-adjust ratcheting strap buckles mounted to skirt
- Supple, high-grade silicone seals gently and securely against the face
- Tempered glass lenses
- Easy-access nose pocket for equalization
- Excellent value



PRODUCT	*CASE PACK	CODE		RRP €
F1 SMALL MASK BLUE	-	ZDN311020		49,99
F1 SMALL MASK PINK	-	ZDN311040		49,99
F1 SMALL MASK TURQUOISE	-	ZDN311028		49,99

METIS ACTION

LOW VOLUME MASK FOR ACTION CAM

Mask based on METIS model that incorporates an adaptor on the frame for easy assembly of Action Cam cameras. The frame has been reinforced in thickness in the assembly area of the camera and includes by default the screw with fixing knob and

camera inclination adjustment. Buckles rotate 100% in all directions thanks to the flexible anchorage and allow a microadjustment with one hand by means of a button.

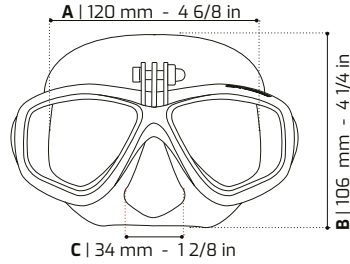

- MICROMETRIC ADJUSTABLE BUCKLE
- TEMPERED GLASS
- 100% HIGH QUALITY SILICONE SKIRT

TECHNICAL FEATURES

- Skirt with more than 85% of adaptability
- Adjustable 360° rotating buckles
- Skirt and strap made of clear or black liquid silicone
- Internal volume 130 cm³
- Weight 190 g



PRODUCT	*CASE PACK	CODE		RRP €
METIS ACTION BLACK/FRAME BLACK	-	US412550		59.99

ACTION

MASK FOR ACTION CAM

Mask based on FOCUS model that incorporates an adaptor on the frame for easy assembly of Action Cam cameras. The frame has been reinforced in thickness in the assembly area of the camera and includes by default the screw with fixing knob and

camera inclination adjustment. Buckles rotate 100% in all directions thanks to the flexible anchorage and allow a microadjustment with one hand by means of a button.

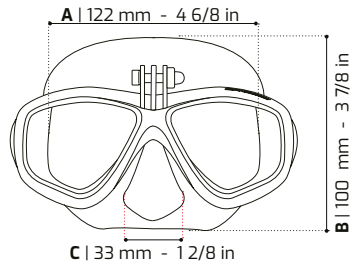

CLEAR/CLEAR

BLACK

MICROMETRIC ADJUSTABLE BUCKLE | TEMPERED GLASS | 100% HIGH QUALITY SILICONE SKIRT

TECHNICAL FEATURES

- Skirt with more than 85% of adaptability
- Adjustable 360° rotating buckles
- Skirt and strap made of clear or black liquid silicone
- Internal volume 130 cm³
- Weight 190 g



PRODUCT	*CASE PACK	CODE	RRP €
ACTION MASK SIL CLEARL/FRAME CLEAR	-	DS410060	69,99
ACTION MASK SIL BLACK/FRAME BLACK	-	DS415050	69,99

MINIMA

THE LOWEST VOLUME ON THE MARKET

This mask was designed specifically for deep sea diving, with innovative features that place it at the top of its category. The special reduced skirt, complete with a small seal ring, sticks like a suction cup to the face, leaving minimum air space inside the mask, which make compensation extremely easy, taking very little air from the lungs.

The lens-eye distance is the absolute smallest on the market and guarantees, even with small diameter lenses, excellent visibility in all directions. The two optic glass lenses are thicker than the standard to allow a special safety mould. The strap comes with instantly adjusting buckles for an easy and precise fit.

- REDUCED SKIRT
- EASY COMPENSATION
- EXCELLENT VISIBILITY
- ADJUSTING BUCKLE
- 100% HIGH QUALITY SILICONE SKIRT

TECHNICAL FEATURES

- Materials: liquid silicone, hi-tech polymers
- Strap buckles: instant adjustment
- Internal very low volume
- Dimensions of frame: 168 x 45 mm
- Weight: 118 g

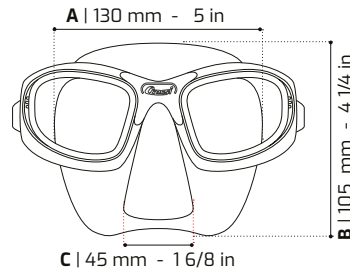

PRODUCT	CASE PACK	CODE	RRP €
MINIMA MASK BLACK/BLACK	6	DS292050	59,99



SUPEROCCHIO

CLASSIC LOW VOLUME MASK

A huge classic in Cressi masks, it continues to be a favourite among fans even though it has been in production for many years. It's a small mask with minimum internal volume, very well suited for

deep freediving. The size of the skirt is limited, and the mask adapts easily to many facial shapes. The two separate lenses, placed very near the eyes, offer great visibility in every direction.

- EASY ADJUSTABLE BUCKLE
- TEMPERED GLASS
- 100% HIGH QUALITY SILICONE SKIRT

TECHNICAL FEATURES

- Minimum internal volume
- Suitable for deep freediving
- The size of the skirt is reduced, and the mask adapts easily to many facial shapes
- The two separate lenses, placed very near the eyes, offer great visibility in every direction
- Made in Italy

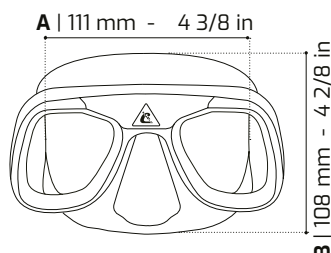

PRODUCT	*CASE PACK	CODE	RRP €
SUPEROCCHIO MASK SIL BLACK/FRAME BLACK	6	DN234650	54,99



MASKS NEGATIVE OPTICAL LENSES

QUANTUM, BIG EYES EVO. MASKS - NEGATIVE CORRECTION

Asymmetrical Lenses, from -1.00 to -6.00 diopters with 0.5 diopter intervals

PRODUCTS	DX - RIGHT	SX - LEFT		RRP €
QUANTUM - BIG EYES EVO OPT.LENS -1,00	DI336010	DI336110		59,99
QUANTUM - BIG EYES EVO OPT.LENS -1,50	DI336015	DI336115		59,99
QUANTUM - BIG EYES EVO OPT.LENS -2,00	DI336020	DI336120		59,99
QUANTUM - BIG EYES EVO OPT.LENS -2,50	DI336025	DI336125		59,99
QUANTUM - BIG EYES EVO OPT.LENS -3,00	DI336030	DI336130		59,99
QUANTUM - BIG EYES EVO OPT.LENS -3,50	DI336035	DI336135		59,99
QUANTUM - BIG EYES EVO OPT.LENS -4,00	DI336040	DI336140		59,99
QUANTUM - BIG EYES EVO OPT.LENS -4,50	DI336045	DI336145		59,99
QUANTUM - BIG EYES EVO OPT.LENS -5,00	DI336050	DI336150		59,99
QUANTUM - BIG EYES EVO OPT.LENS -5,50	DI336055	DI336155		59,99
QUANTUM - BIG EYES EVO OPT.LENS -6,00	DI336060	DI336160		59,99

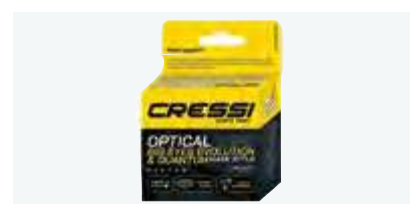
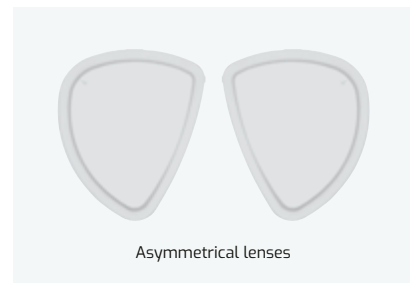

FOCUS, PRISMA MASK - NEGATIVE CORRECTION PRODUCT UPDATE

Symmetrical Lens, from -1.00 to -8.00 diopters with 0.5 diopter intervals

PRODUCTS	CODE		RRP €
OPT.LENS FOCUS - PRISMA - 1.0 DX/SX	DI240010		54,99
OPT.LENS FOCUS - PRISMA - 1.5 DX/SX	DI240015		54,99
OPT.LENS FOCUS - PRISMA - 2.0 DX/SX	DI240020		54,99
OPT.LENS FOCUS - PRISMA - 2.5 DX/SX	DI240025		54,99
OPT.LENS FOCUS - PRISMA - 3.0 DX/SX	DI240030		54,99
OPT.LENS FOCUS - PRISMA - 3.5 DX/SX	DI240035		54,99
OPT.LENS FOCUS - PRISMA - 4.0 DX/SX	DI240040		54,99
OPT.LENS FOCUS - PRISMA - 4.5 DX/SX	DI240045		54,99
OPT.LENS FOCUS - PRISMA - 5.0 DX/SX	DI240050		54,99
OPT.LENS FOCUS - PRISMA - 5.5 DX/SX	DI240055		54,99
OPT.LENS FOCUS - PRISMA - 6.0 DX/SX	DI240060		54,99

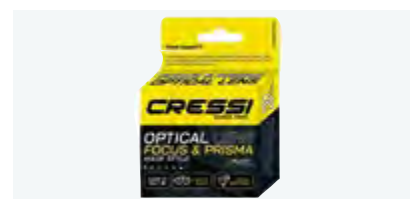
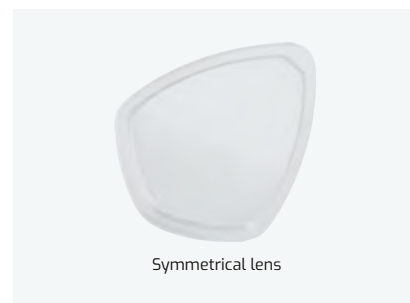

MASKS POSITIVE OPTICAL LENSES

QUANTUM, BIG EYES EVO. MASKS - POSITIVE CORRECTION

Asymmetrical Bifocal Lenses, from +1.00 to +3.00 diopters with 0.5 diopter intervals

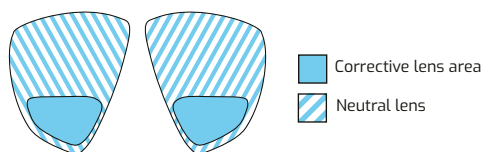

PRODUCTS	DX - RIGHT	SX - LEFT		RRP €
QUANTUM - BIG EYES EVO OPT.LENS +1.00	DI335010	DI335110		69.99
QUANTUM - BIG EYES EVO OPT.LENS +1.50	DI335015	DI335115		69.99
QUANTUM - BIG EYES EVO OPT.LENS +2.00	DI335020	DI335120		69.99
QUANTUM - BIG EYES EVO OPT.LENS +2.50	DI335025	DI335125		69.99
QUANTUM - BIG EYES EVO OPT.LENS +3.00	DI335030	DI335130		69.99

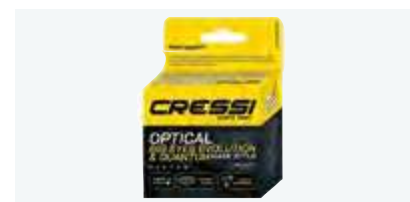
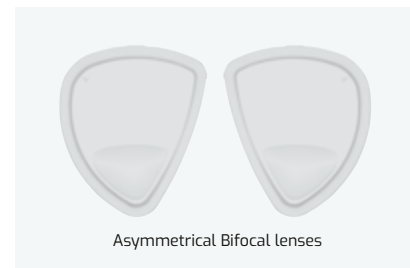

FOCUS, PRISMA - POSITIVE CORRECTION

NEW 2025

Asymmetrical Bifocal Lenses, from +1.00 to +3.00 diopters with 0.5 diopter intervals

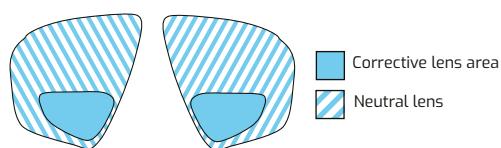

PRODUCTS	DX - RIGHT	SX - LEFT		RRP €
FOCUS - PRISMA OPT.LENS +1.00	DI240210	DI240110		64.99
FOCUS - PRISMA OPT.LENS +1.50	DI240215	DI240115		64.99
FOCUS - PRISMA OPT.LENS +2.00	DI240220	DI240120		64.99
FOCUS - PRISMA OPT.LENS +2.50	DI240225	DI240125		64.99
FOCUS - PRISMA OPT.LENS +3.00	DI240230	DI240130		64.99

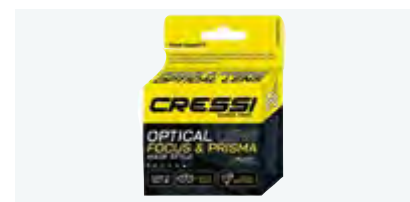

/ MASKS ACCESSORIES

ANTIFOG 0% ALCOHOL 60 ML

Effective anti-fog for masks and goggles. Spread on the inside of the lenses, before wetting them.



CODE		RRP €
DF200050		11,99

ANTIFOG 0% ALCOHOL 60 ML (X2)

Effective anti-fog for masks and goggles. Spread on the inside of the lenses, before wetting them.



CODE		RRP €
XDF200201		17,99

SIMPLY NEO MASK STRAP COVER

SOFT NEOPRENE STRAP COVER



COLOR	CODE		RRP €
YELLOW/BLACK	DQ011050		19,99
BLUE/WHITE	DQ012030		19,99
BLUE NAVY/WHITE	DQ012730		19,99
PINK/WHITE	DQ014030		19,99
BLACK/YELLOW	DQ015010		19,99

PONY TAIL NEO MASK STRAP COVER

SOFT NEOPRENE STRAP COVER



COLOR	CODE		RRP €
YELLOW/BLACK	DQ011050		19,99
BLUE/WHITE	DQ012030		19,99
PINK/WHITE	DQ014030		19,99
BLACK/YELLOW	DQ015010		19,99

ANTIFOG GEL 0% ALCOHOL 30 ML

Effective anti-fog for masks and goggles. Spread on the inside of the lenses, before wetting them.



CODE		RRP €
DF200052		9,99

LENS CLEANER

ANTI FOG MONODOSE TREATMENT

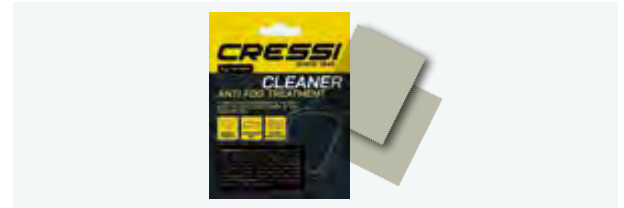

PRODUCT	CODE		RRP €
CLEANER	DF200300		5,99

MASK STRAP COVER

NEW COLORS 2025

SOFT NEOPRENE STRAP COVER



COLOR	CODE		RRP €
BLUE	D5339992		15,99
PINK	D5339994		15,99
BLACK	D5339995		15,99
GREY	D5339991		15,99
YELLOW	D5339996		15,99
RED	D5339997		15,99





FIJI

PATENTED ANTI-FOG SYSTEM

DOUBLE INJECTION TECHNOLOGY

INCLINED LENSES

TEXTILE STRAP

TEMPERED GLASS

100% HIGH QUALITY SILICONE SKIRT

ADVANCED ANTI-FOG SYSTEM + TEXTILE STRAP MASK

FIJI is a snorkeling mask that features the ultimate Cressi Fog Reducer System. A system of membranes channels the air towards the lower part of the mask, away from the glasses. A second membrane seals the eye socket, so that warm air coming from exhalation does not get on contact with the glass at all. This dramatically limits the fogging of the mask. Another feature of our Fog Reducer system is the heat exchanging structure on the top of the mask silicone blades facilitate heat exchange between the mask and the water, balancing the temperature between the two in a shorter time. This also helps to reduce fogging. Fiji is a mask thought for snorkeling. It features an elastic band, making it an easy to

use mask, that will be appreciated by beginners, people with long hair. It can be used for scuba diving too, but keep in mind that an elastic strap is not as firm as a silicon one. The lenses are not treated chemically and it should be remembered that when the mask is new, as is the case with all masks, we advise you to clean them well with a strong soap (toothpaste, dishwashing liquid soap, degreaser). Also use perform the normal antifogging procedure before using the mask, with an anti-fog spray or saliva on the dry glass.

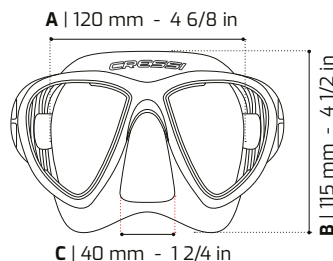

BLACK/BLUE

BLACK/BLACK

CLEAR/AQUAMARINE

CLEAR/BLUE

PRODUCT	*CASE PACK	CODE	RRP €
FIJI MASK BLACK/BLUE	12	DN225020	44,99
FIJI MASK BLACK/BLACK	12	DN225050	44,99
FIJI MASK CLEAR/AQUAMARINE	12	DN220025	44,99
FIJI MASK CLEAR/BLUE	12	DN220020	44,99

INNER MEMBRANES

A patented membrane surrounding the inner nose pocket (1) and both the inner eyes pockets (2) which acts as a barrier and traps any moisture escaping from the diver's nose involuntarily when breathing through the mouth. The result is that not only is the moisture channeled away from the lenses, thus avoiding the fogging up of them, but it also reduces the need to compensate for pressure.

To further improve the anti-fog effect, Cressi suggests, the first times that the dive mask is used, to spray some anti-fog solution or to apply some saliva on the inside of the lenses and then to rinse them with water.

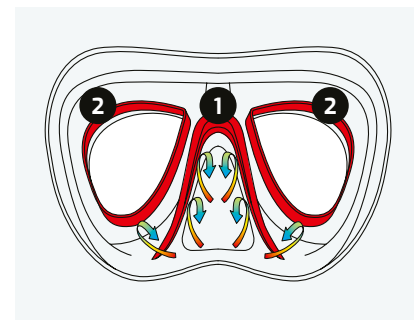

HEAT EXCHANGER

The external part of the skirt features a cooling system composed of two small heat exchangers that act as radiators (3). Thanks to this system, the temperature inside mask drops, coming closer to the external temperature and the droplets of humidity are trapped before the air reaches the lenses, preventing them from fogging up.



NEW TEXTILE ELASTIC STRAP

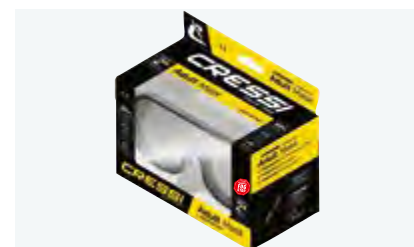

SAMOA

ADVANCED ANTI-FOG SYSTEM + TEXTILE STRAP MASK

PATENTED ANTI-FOG SYSTEM

DOUBLE INJECTION TECHNOLOGY

TEXTILE STRAP

TEMPERED GLASS

100% HIGH QUALITY SILICONE SKIRT

Samoa is a mask that features our efficient Fog-Stop system, on a smaller frame suitable for people with a smaller face. A system of membranes channels the air towards the lower part of the mask, away from the glasses. A second membrane seals the eye socket, so that warm air coming from exhalation does not get in contact with the glass at all. This dramatically limits the fogging of the mask.

Another feature of our fog stop system is the heat exchanging structure on the top of the masks silicone blades facilitate heat exchange between the mask and the water, balancing the temperature between the two in a shorter time. This also helps to reduce fogging. Samoa is a mask thought for people with a smaller face. It allows women and younger people to use our performing Fog-Stop System.

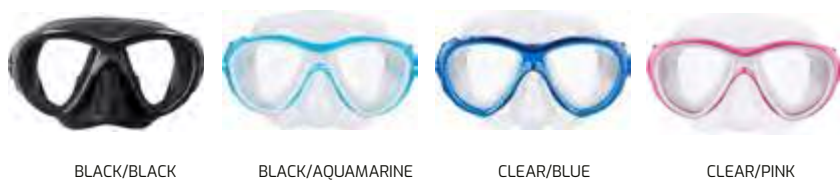
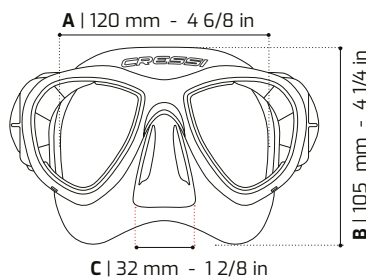

PRODUCT	CASE PACK	CODE	RRP €
SAMOA MASK BLACK/BLACK	12	DN245050	44,99
SAMOA MASK CLEAR/AQUAMARINE	12	DN240025	44,99
SAMOA MASK CLEAR/BLUE	12	DN240020	44,99
SAMOA MASK CLEAR/PINK	12	DN240040	44,99

INNER MEMBRANES

A patented membrane surrounding the inner nose pocket (1) and both the inner eyes pockets (2) which acts as a barrier and traps any moisture escaping from the diver's nose involuntarily when breathing through the mouth. The result is that not only is the moisture channeled away from the lenses, thus avoiding the fogging up of them, but it also reduces the need to compensate for pressure.

To further improve the anti-fog effect, Cressi suggests, the first times that the dive mask is used, to spray some anti-fog solution or to apply some saliva on the inside of the lenses and then to rinse them with water.

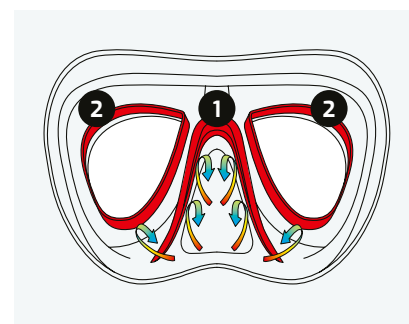

HEAT EXCHANGER

The external part of the skirt features a cooling system composed of two small heat exchangers that act as radiators (3). Thanks to this system, the temperature inside mask drops, coming closer to the external temperature and the droplets of humidity are trapped before the air reaches the lenses, preventing them from fogging up.



NEW TEXTILE ELASTIC STRAP

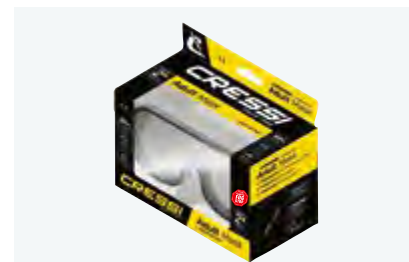

ESTRELLA

ADULT SIZE

The quality of the assembly and of the materials is the same as the most technical range: sturdy tempered glass, polycarbonate frame of reduced thickness and weight, simple and resistant buckles integrated into the frame and in the front-side, silicone strap. Its design is studied to obtain a very wide vision in all directions. Buckles 100% swiveling

in all directions thanks to the flexible anchorage, and micro-adjustment with one hand at the push of a button. They avoid the usual breakage of this critical point and maintain the stability of the mask, once positioned and with the strap on.

1 WINDOW MASK

MICROMETRIC ADJUSTABLE BUCKLE

TEMPERED GLASS

100% HIGH QUALITY SILICONE SKIRT

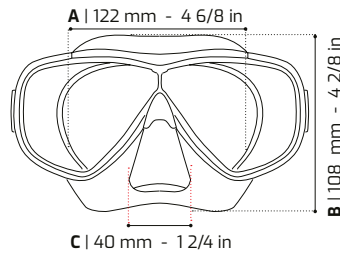

CLEAR/BLUE



CLEAR/AQUAMARINE



CLEAR/PINK



CLEAR ASSORTED



BLACK



BLACK/BLUE

PRODUCT	*CASE PACK	CODE	RRP €
ESTRELLA MASK CLEAR/BLUE	12	DN340020	34.99
ESTRELLA MASK CLEAR/AQUAMARINE	12	DN340063	34.99
ESTRELLA MASK CLEAR/PINK	12	DN340040	34.99
ESTRELLA MASK ASS. COL.	12	DN340099	34.99
ESTRELLA MASK BLACK/BLACK	12	DN345050	34.99
ESTRELLA MASK BLACK/BLUE	12	DN345020	34.99



MAREA

ADULT SIZE

Evolution of the legendary Focus model, the most versatile and one of the most successful Cressi masks. The frame design is minimized in thickness and the lenses are slightly angled to improve vertical and horizontal visibility. Buckles with flexible anchorage 100% pivoting in all directions thanks to its flexible anchorage and

with micro adjustment by button, with one hand. They avoid the usual breakages in this delicate point and maintain the stability of the mask once positioned and with the strap pulled. 100% multi-purpose mask suitable for apnea, snorkeling and diving. Very resistant also for use in diving centers or intensive use.

2 WINDOW MASK

MICROMETRIC ADJUSTABLE BUCKLE

TEMPERED GLASS

100% HIGH QUALITY SILICONE SKIRT

TECHNICAL FEATURES

- Type: double-lenses mask.
- Internal volume: 130cm³ weight 165 gr (junior 80cm³ 120 gr).
- Clear silicone or dark silicone strap and skirt.
- 360° adjustable pivoting buckles, perfect also for diving centers' usage or intensive use.
- Skirt with adaptable percentage of more than 85%.

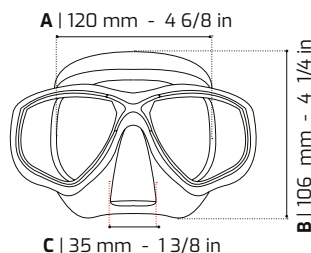

PRODUCT	CASE PACK	CODE	RRP €
MAREA MASK SIL BLUE	12	DN282020	34,99
MAREA MASK SIL LILAC	12	DN282041	34,99
MAREA MASK SIL CLEAR/YELLOW	12	DN281010	34,99
MAREA MASK SIL CLEAR BLUE	12	DN281020	34,99
MAREA MASK SIL CLEAR PINK	12	DN281040	34,99
MAREA MASK SIL CLEAR /FRAME ASSORTED	12	DN281000	34,99
MAREA MASK SIL BLACK/FRAME BLACK	12	DN285050	34,99



OCEAN

NEW COLOR 2025

2 WINDOW MASK

MICROMETRIC ADJUSTABLE BUCKLE

TEMPERED GLASS

100% HIGH QUALITY SILICONE SKIRT

ADULT SIZE

The patented concept of raked lenses and their special "inverted drop" is developed further here. The lenses are placed as closely as possible to the eyes, with the further increase in the field of vision taken to the maximum levels possible. The soft silicone skirt has a new profile and a wide sealing ring for excellent grip and unprecedented comfort.

The internal volume of the mask is exceptionally low, lower than that of many free diving models and the weight is decidedly low. Two pressure buckles, integrated into the headband, allow for quick and accurate adjustment of the strap.



TECHNICAL FEATURES

- Type: double-lenses mask.
- Clear silicone or dark silicone strap and skirt.
- 360° adjustable pivoting buckles, perfect also for diving centers' usage or intensive use.
- Skirt with adaptable percentage of more than 85%.



CLEAR ASSORTED

PRODUCT	*CASE PACK	CODE	RRP €
OCEAN MASK SIL CLEAR/FRAME BLACK	12	DN291050	39.99
OCEAN MASK SIL CLEAR/FRAME CLEAR	12	DN291060	39.99
OCEAN MASK SIL CLEAR/FRAME AQUAMARINE	12	DN291063	39.99
OCEAN MASK SIL/FRAME ASSORTED	12	DN291099	39.99
OCEAN MASK BLACK/BLACK	6	DN295050	39.99
OCEAN MASK BLACK/BLUE	6	DN295020	39.99



SKY

ADULT SIZE

Modern, single lens mask, with a very attractive look. The soft silicone skirt complete with broad internal seal ring, offers great comfort even with prolonged use. The very streamlined frame guarantees good visibility in every

direction. The strap buckles are revolving, for instant adjustment. Excellent mask for general use: snorkeling, scuba diving.



TECHNICAL FEATURES

- Type: single lens mask
- Materials: liquid silicone, hi-tech polymers
- Strap buckles: revolving, instant adjustment
- Internal volume: normal
- Dimensions of frame: 165 x 80 mm
- Weight: 200 g



PRODUCT	CASE PACK	CODE	RRP €
SKY MASK SIL/FRAME ASSORTED	12	DN200000	39.99



Photo by: Ourdays

/ SNORKELING MASKS

ONDA

ADULT SIZE

This mask has a single tempered glass lens, and is designed for snorkeling, swimming and scuba diving. The skirt is made from soft hypoallergenic transparent silicone. The visibility provided by the

single lens and the unusual shape of the frame extends in all directions. Excellent seal on many face types, average internal volume.

1 WINDOW MASK

MICROMETRIC ADJUSTABLE BUCKLE

TEMPERED GLASS

100% HIGH QUALITY SILICONE SKIRT

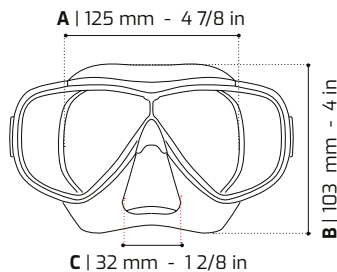

CLEAR/YELLOW



CLEAR/BLUE



CLEAR/PINK



BLACK



ASSORTED

PRODUCT	*CASE PACK	CODE	RRP €
ONDA MASK SIL CLEAR/FRAME YELLOW	12	DN207010	27.99
ONDA MASK SIL CLEAR/FRAME BLUE	12	DN207020	27.99
ONDA MASK SIL CLEAR/FRAME PINK	12	DN207040	27.99
ONDA MASK SIL BLACK/FRAME BLACK	12	DN207150	27.99
ONDA MASK SIL/FRAME ASSORTED	12	DN207000	27.99



/ SNORKELING MASKS

PERLA

NEW COLOR 2025

2 WINDOW MASK

MICROMETRIC ADJUSTABLE BUCKLE

TEMPERED GLASS

100% HIGH QUALITY SILICONE SKIRT

ADULT SIZE

A mask particularly suitable for free diving and snorkeling, but just as appropriate for use in scuba diving. It has separate lenses, a skirt edge fitting most of the faces and a small inner volume, perfect for free-divers. Sturdy tempered glass, polycarbonate frame. It is made from soft

transparent or dark silicone, and comes with strong rapid action buckles to adjust the strap. The quality of the assembly and of the materials is the same as the most technical range

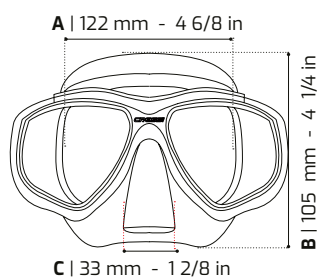

PRODUCT	*CASE PACK	CODE	RRP €
PERLA MASK SIL BLACK/FRAME BLACK	12	DN208150	24,99
PERLA MASK SIL BLACK/FRAME BLUE	12	DN208550	24,99
PERLA MASK SIL GREEN/FRAME BLACK	12	DN208198	24,99
PERLA MASK SIL/FRAME ASSORTED	12	DN208000	24,99
PERLA MASK CLEAR/BLUE	12	DN207920	24,99
PERLA MASK CLEAR/PINK	12	DN207940	24,99
PERLA MASK CLEAR/BLACK	12	DN207950	24,99
PERLA MASK CLEAR/AQUAMARINE	12	DN207963	24,99



SIRENA

ADULT SIZE

This Sirena has a single tempered glass lens and is designed for snorkeling, swimming and scuba diving. The skirt is made from soft hypoallergenic transparent or black silicone. The visibility provided by the single lens and the unusual shape of the frame extends in all directions. Excellent seal on most face types, thanks to the internal seal ring housing average internal volume. It has quick-release strap buckles.

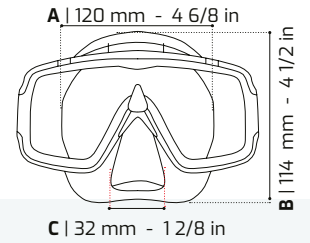

BLACK/SMOKED BLACK



ASSORTED



BLACK/RED

PRODUCT	*CASE PACK	CODE	RRP €
SIRENA MASK SIL/FRAME ASSORTED.	12	DN201000	22.99
SIRENA MASK SIL BLACK/FRAME SMOKED BLACK	12	DN202000	22.99
SIRENA MASK SIL BLACK/FRAME RED	12	JDN200058	22.99



PINOCCHIO

ADULT SIZE CLASSIC MASK

A real CULT when it comes to masks, Pinocchio is the most famous mask in the world. It began life in the first half of the '50s, and was the first mask that came with a special lodging for the nose, making compensation possible. Adored by entire diving generations all over the world, its design was so advanced at the time it was launched on the market, that it is still valid today.

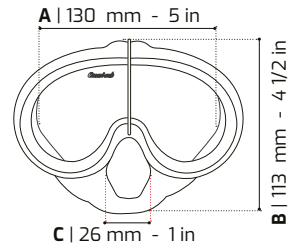

FIRST MASK WITH A NOSE POCKET SINCE 1952

PRODUCT	*CASE PACK	CODE	RRP €
PINOCCHIO MASK BLACK/FRAME BLACK	12	DN210000	34.99





SNORKELING MASKS JUNIOR

Photo by: Jason Arnold

ESTRELLA JUNIOR

WITH TEXTILE STRAP - AGE 7-13

This new version of the Estrella has an elasticated fabric strap without adjustment buckles to make it easier for children to put on and to avoid pulling the hair. The traditional snorkel clip has been replaced with a loop created with the fabric strap

supporting and positioning the snorkel. The same mask can be fitted with both the silicon and fabric straps via an attachment pin.



TECHNICAL FEATURES

- Kids diving mask for kids from 7 to 13 years old.
- Suitable for snorkeling and also scuba diving.
- Single tempered glass lens



NEW STRAP, EASIER FOR CHILDREN TO PUT ON



SNORKEL LOOP CREATED WITH THE FABRIC STRAP



BLUE

CLEAR/AQUAMARINE

CLEAR PINK



ASSORTED

PRODUCT	CASE PACK	CODE	RRP €
ESTRELLA JR TXLE STRAP MASK BLUE	12	DN351050	34,99
ESTRELLA JR TXLE STRAP MASK CLEAR/AQUAM	12	DN351025	34,99
ESTRELLA JR TXLE STRAP MASK CLEAR/PINK	12	DN351040	34,99
ESTRELLA JR TXLE STRAP MASK ASS. COL.	12	DN351099	34,99



MAREA JUNIOR

AGE 7-13

The Marea Junior is a 2 lens Mask that is particularly suitable for scuba diving and snorkeling. It has dual tempered glass lenses, a double feathered skirt edge that adapts to most faces and a small inner volume that is perfect when going deep underwater. The Marea Junior is made from 100% clear high-quality sealing soft silicone rubber that offers extraordinary and unprecedented comfort and fit.

Designed for younger and women divers the Marea Junior Mask gives an exceptionally wide field of view. Mask is equipped with Cressi's micrometric easy adjust buckles and has a wide silicone rubber split strap designed mask strap for even dispersion of pressure for increased fit and comfort. Mask has an easy-to-reach one-hand nose pocket for ear equalization.

- WINDOW 2
- EASY ADJUSTABLE BUCKLE
- TEMPERED GLASS
- 100% HIGH QUALITY SILICONE SKIRT

TECHNICAL FEATURES

- Scuba, free diving and snorkeling mask
- Dual tempered glass lens for durability.
- Easy Adjustable buckle.
- 100% High Quality Silicone.
- Wide field of view.
- Soft silicone mask skirt for comfort.
- Designed for women and younger divers.

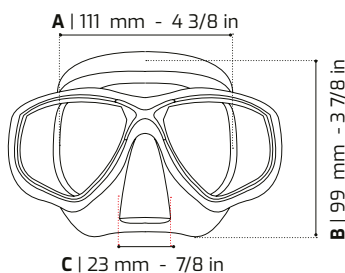

PRODUCT	CASE PACK	CODE	RRP €
MAREA JR MASK SIL BLUE	12	DN284020	29,99
MAREA JR MASK SIL LILAC	12	DN284041	29,99
MAREA JR MASK SIL CLEAR YELLOW	12	DN283010	29,99
MAREA JR MASK SIL CLEAR BLUE	12	DN283020	29,99
MAREA JR MASK SIL CLEAR PINK	12	DN283040	29,99
MAREA JR MASK SIL CLEAR ASSORTED	12	DN283000	29,99

ONDINA JUNIOR

AGE 7-13

Smaller version of the Onda mask, suitable for young people and women with narrow faces. This mask has a single lens, and is designed for snorkeling, swimming and scuba diving. The skirt is made from soft hypoallergenic transparent silicone. The visibility provided by the single lens and the unusual shape of the frame extends in all directions. Excellent seal on many face types, small internal volume. Quick-release strap buckles.

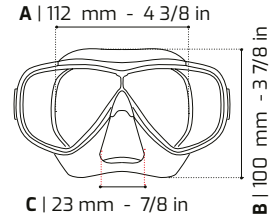

ASSORTED

PRODUCT	CASE PACK	CODE	RRP €
ONDINA JR MASK SIL/FRAME ASSORTED.	12	DN206900	24.99



PERLA JUNIOR

AGE 7-13

Smaller version of the PERLA mask, suitable for women and young people. This mask has separate lenses, a skirt edge that adapts to most faces and a small inner volume, perfect for free-divers. The skirt is made from soft hypoallergenic transparent silicone. The visibility provided by the double lens and the unusual shape of the frame extends in all directions. Excellent seal on many face types. Quick-release strap buckles.



WINDOW 2 EASY ADJUSTABLE BUCKLE TEMPERED GLASS 100% HIGH QUALITY SILICONE SKIRT

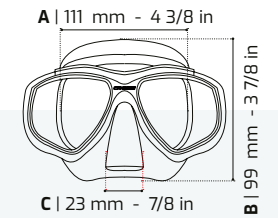

CLEAR/BLUE



CLEAR/PINK



CLEAR/AQUAMARINE



CLEAR/LIME



ASSORTED

PRODUCT	CASE PACK	CODE	RRP €
PERLA JR MASK CLEAR/BLUE	12	DN208420	22.99
PERLA JR MASK CLEAR/PINK	12	DN208440	22.99
PERLA JR MASK CLEAR/AQUAMARINE	12	DN208463	22.99
PERLA JR MASK CLEAR/LIME	12	DN208467	22.99
PERLA JR MASK SIL/FRAME ASSORTED	12	DN208300	22.99



SIRENETTA JUNIOR

AGE 7-13

The Sirenetta is the smaller version of the popular Sirena mask, mainly designed for women and young divers. This mask has a single lens and is designed for snorkeling, swimming and scuba diving. The visibility provided by the single lens and the unusual shape of the frame extends in all directions. The skirt is made of soft hypoallergenic silicone that adapts at the face ensuring comfort and a perfect seal. The strap is slit and made of silicone to ensure comfort and a perfect hold. The length of the strap is easy to adjust thanks to the quick-release strap buckles.

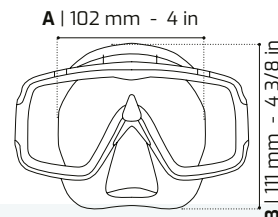

ASSORTED

PRODUCT	*CASE PACK	CODE	RRP €
SIRENETTA JR MASK SIL/FRAME ASSORTED.	12	DN203000	21.99



MOON

AGE 5-10

Perfect for swimming, snorkeling, and enjoying underwater nature, these lenses are ideal for young adventurers. The shatterproof lenses with anti-scratch treatment ensure durability and safety, giving parents peace of mind. With perfect adaptability to a wide range of facial profiles, they provide a comfortable and secure fit for children. The micrometric indestructible buckles make adjustments easy, ensuring a snug fit every time. Encourage your kids to become real water enthusiasts with gear that is reliable, comfortable, and easy to use.



CLEAR/LIME



CLEAR/BLUE



CLEAR/LILAC



PINK/LILAC



LIGHT BLUE/LIME



BLUE/ORANGE



PINK/WHITE



ASSORTED

PRODUCT	*CASE PACK	CODE	RRP €
MOON KID MASK SIL CLEAR/FRAME LIME	12	DN200667	24.99
MOON KID MASK SIL CLEAR/FRAME BLUE	12	DN200620	24.99
MOON KID MASK SIL CLEAR/FRAME LILAC	12	DN200641	24.99
MOON KID MASK SIL LIGHT BLUE/FRAME LIME	12	DN200720	24.99
MOON KID MASK SIL PINK/FRAME LILAC	12	DN200740	24.99
MOON KID MASK BLUE/ORANGE	12	DN200828	24.99
MOON KID MASK PINK/WHITE	12	DN200834	24.99
MOON KID MASK SIL/FRAME ASSORTED	12	DN200600	24.99



PIUMETTA KID

AGE 3-6

Piumetta is not only a minimized version of a senior diving mask, as we already produce a junior version called the ondina, rather all of the dimensions have been reconfigured for optimum adaptation to the physiology of smaller individuals. Thus, not only the critical frame

contact areas (nose, bro, etc.) are left protected, rather the eyes are perfectly centered in the glass display for maximum visibility. Piumetta shares the frame materials and technology used in professional masks with soft silicone and a sturdy polycarbonate display

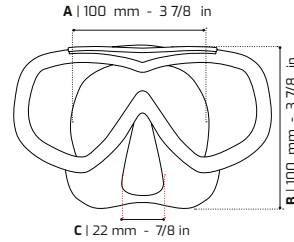

PRODUCT	*CASE PACK	CODE	RRP €
PIUMETTA KID MASK SIL/FRAME YELLOW	12	DN200510	19.99
PIUMETTA KID MASK SIL/FRAME BLUE	12	DN200520	19.99
PIUMETTA KID MASK SIL/FRAME PINK	12	DN200540	19.99
PIUMETTA KID MASK SIL AQUAMARINE	12	DN200563	19.99
PIUMETTA KID MASK SIL/FRAME ASSORTED	12	DN200500	19.99

/ MASKS SPARE PARTS

MASK STRAP LOOP

LARGE CLEAR (2PCS)



CODE		RRP €
DZ215007		4,50

MASK STRAP LOOP

LARGE BLACK (2PCS)



CODE		RRP €
DZ215013		4,50

MASK STRAP LOOP

SMALL CLEAR (2PCS)



CODE		RRP €
DZ215009		4,50

MASK STRAP LOOP

SMALL BLACK (2PCS)



CODE		RRP €
DZ215011		4,50

MASK STRAP

CLEAR - FOCUS / BIG EYES

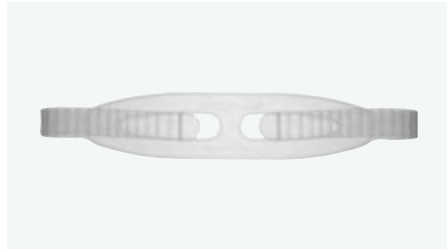

CODE		RRP €
DZ215005		7,99

MASK STRAP

BLACK - FOCUS / BIG EYES / SUPEROCCHIO / PINOCCHIO



CODE		RRP €
DZ215006		7,99

PROFESSIONAL STRAP

CLEAR



CODE		RRP €
DZ215003		8,50

PROFESSIONAL STRAP

BLACK



CODE		RRP €
DZ215004		8,50

STRAP CRYSTAL MASK

SILVER



CODE		RRP €
DZ215002		9,99

STRAP FOR SCUBA MASK

CLEAR

NEW 2025



CODE		RRP €
DZ222000		9,99

STRAP FOR SCUBA MASK

BLACK

NEW 2025



CODE		RRP €
DZ222050		9,99

STRAP FOR SCUBA MASK

BLUE

NEW 2025



CODE		RRP €
DZ222020		9,99

/ MASKS SPARE PARTS

STRAP FOR SCUBA MASK

SILVER

NEW 2025



CODE		RRP €
DZ222051		9,99

STRAP FOR SCUBA MASK

PINK

NEW 2025



CODE		RRP €
DZ222040		9,99

STRAP FOR SCUBA MASK

WHITE

NEW 2025



CODE		RRP €
DZ222030		9,99

STRAP FOR SCUBA MASK

YELLOW

NEW 2025



CODE		RRP €
DZ222010		9,99

STRAP FOR SCUBA MASK

AQUAMARINE

NEW 2025



CODE		RRP €
DZ222025		9,99

TEXTILE STRAP

NEW 2025



CODE		RRP €
DZ240035		9,99

PROFESSIONAL STRAP

DOUBLE INJECTION

NEW 2025

COLOR	CODE		RRP €
BLACK/YELLOW	DZ223501		9,99
BLACK/BLUE METAL	DZ223502		9,99
BLACK/GREY	DZ223505		9,99
BLACK/RED	DZ223508		9,99
BLACK/GOLD	DZ223511		9,99
BLACK/AZURE	DZ223522		9,99
GREY/BLACK	DZ223555		9,99
BLACK/SILVER	DZ223551		9,99
CLEAR/BLUE METAL	DZ223020		9,99
CLEAR/PINK	DZ223040		9,99
CLEAR/BLACK	DZ223050		9,99
WHITE/BLACK	DZ223350		9,99
BLUE METAL	DZ223220		9,99
GREEN/BLACK	DZ223905		9,99



Photo by: Sacha Lobenstein

/ MASKS SPARE PARTS

BUCKLES

BIG EYES MASK BLACK (2PCS)



CODE		RRP €
DZ210008		8,50

BUCKLES

FOCUS MASK BLACK (2PCS)



CODE		RRP €
DZ210010		8,50

BUCKLES

MATRIX / LINCE / PENTA (2PCS)



CODE		RRP €
DZ210018		8,50

BUCKLES

BIG EYES EVOLUTION / OCCHIO PLUS / EYES EVO (2PCS)



CODE		RRP €
DZ210021		8,50

BUCKLES

ONDA/INA /PERLA/JR/SIRENA/ETTA/PIUMETTA/SL A (2PCS)



CODE		RRP €
DZ210005		8,50

BUCKLES

MAREA/MAREA JR /SKY /SKY JR/OCEAN/SL B (2PCS)



CODE		RRP €
DZ210020		8,50

BUCKLES

NEW 2025

ATOM / NAXOS / PENTA+ / QUANTUM / ZEUS (2PCS)



COLOR	CODE		RRP €
BLACK	DZ333505		8,50
CLEAR	DZ333005		8,50

BOX FOR MASK



SIZE	CODE		RRP €
L	DZ250099		8,50
M	DZ250098		8,50

BAG FOR COMBO SET

BLACK



CODE		RRP €
DZ250095		8,50

/ FULL FACE MASKS





FULL FACE MASKS

Photo by: Studio Nicama



DUKE

ADULT SILICONE DRY SIDE SNORKEL FULL FACE MASK

Full-face mask for snorkeling: Designed with extremely high-quality materials and technology. You can explore the world underwater, breathing naturally through the nose and mouth with 0% effort. Its visual field is 30% larger than normal

full face masks. The new air baffle completely eliminates fogging. It features special safety valves for purging water. The snorkel features a special dry system that keeps water out.

- NATURAL BREATHING THROUGH THE NOSE AND MOUTH
- LARGER FIELD OF VISION
- NO FOGGING
- SAFETY VALVE FOR PURGING WATER
- IMPROVED COMFORT FOR PROLONGED USE
- SNORKEL WITH DRY SYSTEM

TECHNICAL FEATURES

180° field of vision	Cressi Duke boasts a visual field that is 30% larger than normal full face masks
Stop fogging	The new baffle that Cressi has created optimizes air circulation, completely eliminating the fogging effect
Safety valves	Special safety valves allow you to easily purge water
Natural breathing	Ample front area lets you breathe naturally through your nose and mouth with 0% effort
Dry Snorkel	The snorkel features a special Dry System that keeps water out of the tube
High quality	Cressi Duke is made using extremely high quality materials and technology. Cressi provides a convenient carrying bag
Size	Available in S/M and M/L. To check the correct size, use a ruler to measure from the chin to the eye line
#cressievolution	Cressi Duke is the evolution of the first full face mask ever produced, called the Medusa, made in 1946

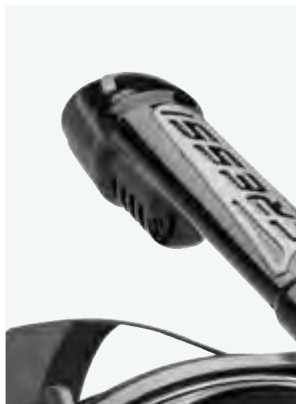

/ FULL FACE MASKS

FIND YOUR DUKE IDEAL SIZE

MEASURE WITH THE RULER FROM THE BOTTOM OF THE CHIN TO THE EYELINE

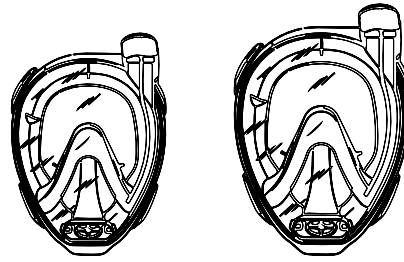

S/M
10-12 CM / 4-4.5 INCH

M/L
>11.5 CM / >4.5 INCH



BLACK/BLUE



BLACK/BLACK



BLACK/RED



CLEAR/SILVER



CLEAR/BLUE



CLEAR/PINK



CLEAR/AQUAMARINE



CLEAR/BLACK



CLEAR/YELLOW

action



BLACK/BLACK



CLEAR/SILVER

COLOR	SIZE	CODE	RRP €
CLEAR/SILVER	S/M	XDT000000	69,99
CLEAR/BLUE	S/M	XDT000020	69,99
CLEAR/PINK	S/M	XDT000040	69,99
CLEAR/AQUAMARINE	S/M	XDT000025	69,99
CLEAR/BLACK	S/M	XDT000050	69,99
CLEAR/YELLOW	S/M	XDT000010	69,99
BLACK/BLUE	S/M	XDT005020	69,99
BLACK/BLACK	S/M	XDT005050	69,99
BLACK/RED	S/M	XDT005058	69,99
ACTION BLACK/BLACK	S/M	XDT005250	79,99
ACTION CLEAR/SILVER	S/M	XDT000255	79,99

COLOR	SIZE	CODE	RRP €
CLEAR/SILVER	M/L	XDT010000	69,99
CLEAR/BLUE	M/L	XDT010020	69,99
CLEAR/PINK	M/L	XDT010040	69,99
CLEAR/AQUAMARINE	M/L	XDT010025	69,99
CLEAR/BLACK	M/L	XDT010050	69,99
CLEAR/YELLOW	M/L	XDT010010	69,99
BLACK/BLUE	M/L	XDT015020	69,99
BLACK/BLACK	M/L	XDT015050	69,99
BLACK/RED	M/L	XDT015058	69,99
ACTION BLACK/BLACK	M/L	XDT005250	79,99
ACTION CLEAR/SILVER	M/L	XDT000255	79,99

BARON

ADULT SILICONE DRY SIDE SNORKEL FULL FACE MASK

Our full face mask's unique features in a new, more essential style.

- NATURAL BREATHING THROUGH THE NOSE AND MOUTH
- LARGER FIELD OF VISION
- NO FOGGING
- SAFETY VALVE FOR PURGING WATER
- IMPROVED COMFORT FOR PROLONGED USE
- SNORKEL WITH DRY SYSTEM

REPRICED %



CLEAR/BLUE



CLEAR/AQUAMARINE



BLACK/BLACK



CLEAR/PINK



BLACK/BLUE

COLOR	SIZE	CODE	RRP €
CLEAR/BLUE	XS	XDT0360020	49,99
CLEAR/AQUAMARINE	XS	XDT0360026	49,99
CLEAR/PINK	XS	XDT0360040	49,99
CLEAR/BLUE	S/M	XDT020020	49,99
CLEAR/AQUAMARINE	S/M	XDT020025	49,99
BLACK/BLACK	S/M	XDT025050	49,99
BLACK/BLUE	S/M	XDT025020	49,99
CLEAR/BLUE	M/L	XDT030020	49,99
CLEAR/AQUAMARINE	M/L	XDT030025	49,99
BLACK/BLACK	M/L	XDT035050	49,99
BLACK/BLUE	M/L	XDT035020	49,99

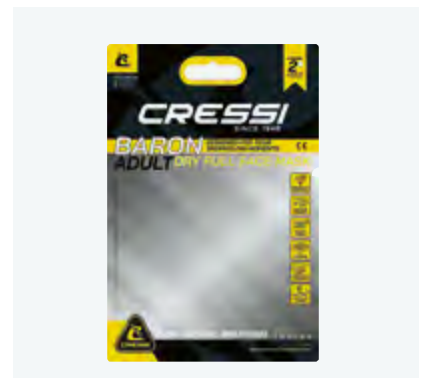

BALI

NEW 2025

DRY FULL FACE MASK FOR ADULTS IN SILICONE WITH CENTRAL SNORKEL

Elevate your snorkelling experience to the next level with the 'Bali' full face mask by Cressi, designed for underwater explorers seeking high quality and comfort. This mask provides a crystal-clear, expanded vision thanks to its ultra-clear polycarbonate lens, allowing you to admire every detail of the marine world.

Comfort is ensured by the 100% silicone skirt, which adapts perfectly to your face, creating an airtight and comfortable seal for a seamless snorkelling experience. In addition, the intelligent design of the dry snorkel, with its flotation

valve, facilitates calm and continuous breathing, preventing water from entering and allowing you to focus on the wonders around you. Safety is a top priority for the 'Bali' mask. The advanced breathing system is a key feature, carefully designed to minimise CO2 stagnation, ensuring a safe and comfortable snorkelling experience. This sophisticated system guarantees that fresh air is constantly renewed in line with the strictest safety standards, giving you the peace of mind to enjoy exploration without worry. Easy to carry with you thanks to the foldable snorkel, the

'Bali' also comes with an adjustable nylon strap and the action camera space, to capture the most exciting moments of your underwater journey. Choose the "Bali" snorkel mask by Cressi for a safe, comfortable and unforgettable underwater adventure, where safety merges with innovation to offer you the ultimate experience.



BLACK/BLUE

BLACK/GREY



BLACK/YELLOW

WHITE/BLACK

TECHNICAL FEATURES

- Advanced, rigorously tested breathing system minimises CO2 stagnation for increased safety.
- Ultra-clear polycarbonate lens for a wide and detailed view of the underwater world.
- 100% silicone face seal for a perfect and comfortable fit, preventing water seepage.
- Dry snorkel with buoyancy valve for uninterrupted, water-free breathing.
- Includes action camera mount and adjustable nylon headband, making the mask ideal for capturing underwater adventures.



COMES WITH ACTION CAM MOUNT



COLOR	SIZE	CODE		RRP €
BALI FULL FACE MASK WHITE/BLACK	S/M	XDT083050		59.99
BALI FULL FACE MASK BLACK/YELLOW	S/M	XDT085010		59.99
BALI FULL FACE MASK BLACK/BLUE	S/M	XDT085020		59.99
BALI FULL FACE MASK BLACK/GREY	S/M	XDT085055		59.99
BALI FULL FACE MASK WHITE/BLACK	L/XL	XDT083150		59.99
BALI FULL FACE MASK BLACK/YELLOW	L/XL	XDT085110		59.99
BALI FULL FACE MASK BLACK/BLUE	L/XL	XDT085120		59.99
BALI FULL FACE MASK BLACK/GREY	L/XL	XDT085155		59.99

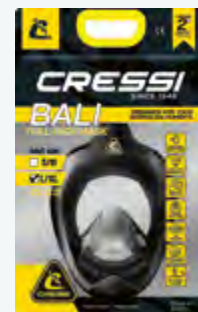



SNORKELLING COMBOS



QUANTUM + ITACA ULTRA DRY

SPECIALIZED
Retailer-Product

ADULT SIZE



INNER MEMBRANES

A patented membrane surrounding the inner nose pocket and both the inner eyes pockets which acts as a barrier and traps any moisture escaping from the diver's nose involuntarily when breathing through the mouth.

HEAT EXCHANGER

The external part of the skirt features a cooling system composed of two small heat exchangers that act as radiators.



BLACK/BLACK

BLACK/BLUE

CLEAR/BLACK

CLEAR/BLUE

COLORS	*CASE PACK	CODE	RRP €
BLACK/BLACK	10	DM405050	119.99
BLACK/BLUE	10	DM405020	119.99
CLEAR/BLACK	10	DM400050	119.99
CLEAR/BLUE	10	DM400020	119.99

CALIBRO + CORSICA

ADULT SIZE

PATENTED ANTI-FOG SYSTEM



CM 24,5X51,5



BLACK



GREEN



BLUE METAL

COLORS	*CASE PACK	CODE	RRP €
BLACK	10	D5435050	79.99
GREEN	10	D5439850	79.99
BLUE METAL	10	D5434550	79.99

BIG EYES EVO + ALPHA ULTRA DRY

ADULT SIZE



YELLOW



BLUE



BLACK/PINK



BLACK



BLACK/BLACK



BLACK/BLUE



BLACK SPECTRA SILVER LENSES

BLACK/BLACK SPECTRA

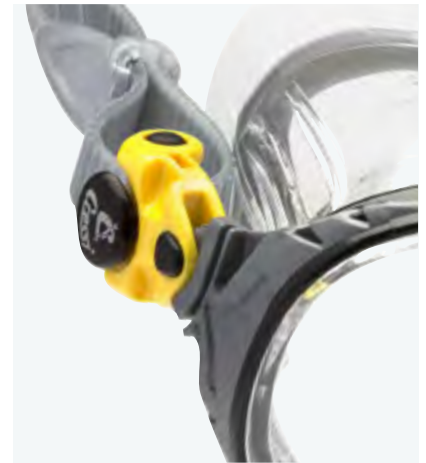

CM 24.5X51.5

PRODUCT	*CASE PACK	CODE	RRP €
YELLOW	10	DS337010	89.99
BLUE	10	DS337020	89.99
BLACK	10	DS337050	89.99
BLACK/BLACK	10	WDS337550	89.99
BLACK/BLUE	10	WDS337520	89.99
BLACK/PINK	10	WDS337040	89.99
BLACK/BLACK SPECTRA	10	WDS337950	109.99

PENTA + ALPHA ULTRA DRY

ADULT SIZE



CLEAR BLUE



BLACK/BLUE



BLACK/BLACK

COLORS	*CASE PACK	CODE	RRP €
CLEAR BLUE	10	D5323002	89,99
SIL. BLACK/BLUE	10	D5323520	89,99
BLACK/BLACK	10	D5323550	89,99

CM 24.5X51.5

F1 + DRY

ADULT SIZE

MICROMETRIC ADJUSTABLE BUCKLE | TEMPERED GLASS | 100% HIGH QUALITY SILICONE SKIRT



PURGE VALVE



DRY GUARD



BLUE



CLEAR/SILVER



BLACK



CM 24,5X51,5

PRODUCT	*CASE PACK	CODE	RRP €
F1 + DRY COMBO BLACK	20	YD5280050	79.99
F1 + DRY COMBO CLEAR	20	YD5280000	79.99
F1 + DRY COMBO BLUE METAL	20	YD5280021	79.99

BIG EYES + SEAL DRY

NEW 2025

ADULT SIZE

MICROMETRIC ADJUSTABLE BUCKLE

TEMPERED GLASS

100% HIGH QUALITY SILICONE SKIRT

FLEXIBLE BUCKLE

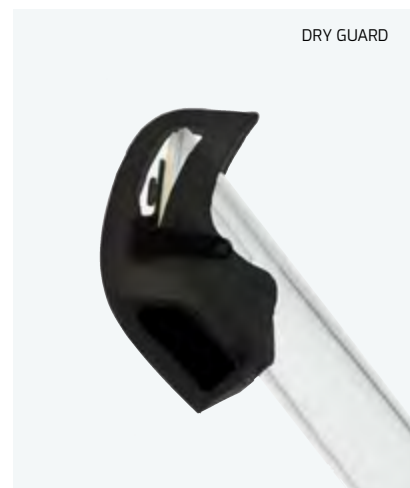

DRY GUARD



PURGE VALVE

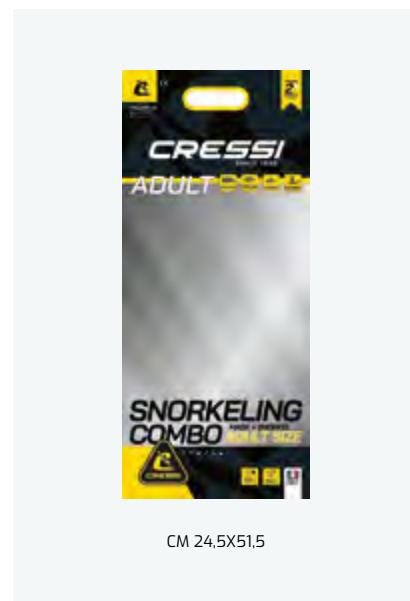

CM 24,5X51,5



CLEAR/AZURE



BLACK/BLACK



CLEAR/BLACK

PRODUCT	*CASE PACK	CODE	RRP €
BIG EYES + SEAL DRY COMBO CLEAR/AZURE	10	DM540022	59,99
BIG EYES + SEAL DRY COMBO BLACK/BLACK	10	DM545050	59,99
BIG EYES + SEAL DRY COMBO CLEAR/BLACK	10	DM540050	59,99

ESTRELLA + SEAL DRY

ADULT SIZE

NEW 2025

TEMPERED GLASS

100% HIGH QUALITY SILICONE SKIRT

FLEXIBLE BUCKLE



CLEAR/BLUE



CLEAR/AQUAMARINE



CLEAR/BLACK



CLEAR/PINK



BLACK

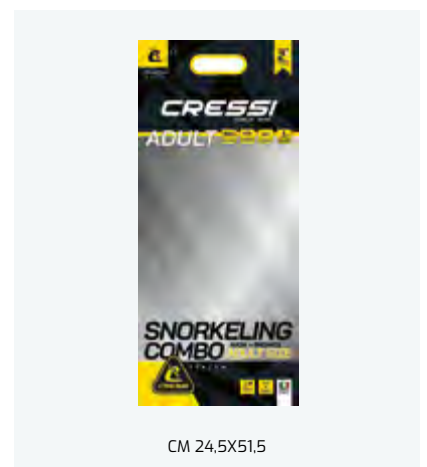

CM 24,5X51,5

PRODUCT	*CASE PACK	CODE	RRP €
CLEAR/BLACK	10	DM550050	49,99
CLEAR/AZURE	10	DM550022	49,99
CLEAR/AQUAMARINE	10	DM550025	49,99
CLEAR/PINK	10	DM550040	49,99
CLEAR/BLACK - CLEAR/CLEAR	10	DM550500	49,99
BLACK/BLACK	10	DM555050	49,99

MATRIX + GAMMA

ADULT SIZE



PRODUCT	*CASE PACK	CODE	RRP €
CLEAR/BLUE	10	DS302501	69,99
CLEAR/YELLOW	10	DS302504	69,99
BLACK	10	DS302510	69,99

METIS + CORSICA HUNTER

ADULT SIZE

- MICROMETRIC ADJUSTABLE BUCKLE
- 100% HIGH QUALITY SILICONE SKIRT
- TEMPERED GLASS
- FLEXIBLE BUCKLE



CM 24.5X51.5



BLACK/BLUE CAMOU

BLACK CAMOU

GREEN CAMOU

PRODUCT	*CASE PACK	CODE	RRP €
METIS + CORSICA COMBO BLACK HUNTER	20	XDM103051	59,99
METIS + CORSICA COMBO GREEN HUNTER	20	XDM103098	59,99
METIS + CORSICA COMBO BLUE HUNTER	20	XDM103020	59,99

FIJI + GAMMA

ADULT SIZE

- INCLINED LENSES
- TEXTILE STRAP
- TEMPERED GLASS
- 100% HIGH QUALITY SILICONE SKIRT
- PATENTED ANTI-FOG SYSTEM
- DOUBLE INJECTION TECHNOLOGY



CRESSI
ADVANCED
FOG STOP



NEW ELASTICATED FABRIC STRAP



SPLASH GUARD



CM 24,5X51,5



BLACK/BLUE

BLACK/BLACK

CLEAR/AQUAMARINE

CLEAR/BLUE

COLORS	*CASE PACK	CODE	RRP €
BLACK/BLUE	10	DM280520	59.99
BLACK/BLACK	10	DM280550	59.99
CLEAR/AQUAMARINE	10	DM280025	59.99
CLEAR/BLUE	10	DM280020	59.99

SAMOA + MEXICO

ADULT SIZE

- TEXTILE STRAP
- TEMPERED GLASS
- 100% HIGH QUALITY SILICONE SKIRT
- PATENTED ANTI-FOG SYSTEM
- DOUBLE INJECTION TECHNOLOGY



NEW ELASTICATED FABRIC STRAP



SPLASH GUARD



BLACK/BLACK

BLACK/AQUAMARINE

CLEAR/BLUE

CLEAR/PINK



CM 24,5X51,5

COLORS	*CASE PACK	CODE	RRP €
CLEAR/BLUE	10	DM291020	49,99
CLEAR/AQUAMARINE	10	DM291025	49,99
CLEAR/PINK	10	DM291040	49,99
BLACK/BLACK	10	DM291550	49,99

MAREA + GAMMA

ADULT SIZE

TEMPERED GLASS | 100% HIGH QUALITY SILICONE SKIRT | FLEXIBLE BUCKLE



CLEAR/YELLOW

CLEAR/BLUE

CLEAR/PINK

BLACK

ASSORTED

COLORS	*CASE PACK	CODE	RRP €
MAREA + GAMMA COMBO CLEAR/YELLOW	10	DM1000051	44,99
MAREA + GAMMA COMBO CLEAR/BLUE	10	DM1000052	44,99
MAREA + GAMMA COMBO CLEAR/PINK	10	DM1000054	44,99
MAREA + GAMMA COMBO BLACK	10	DM1000055	44,99
MAREA + GAMMA COMBO ASSORTED COLORS	10	DM100005	44,99

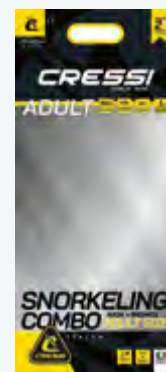

CM 24,5X51,5

OCEAN + GAMMA

ADULT SIZE

NEW COLOR 2025



BLACK/BLUE



CLEAR/AQUAMARINE



BLACK



ASSORTED

COLORS	*CASE PACK	CODE	RRP €
CLEAR/AQUAMARINE	10	DM1000113	49,99
BLACK	10	WDM1000125	49,99
BLACK/BLUE	10	DM100152	49,99
ASSORTED	10	DM100011	49,99

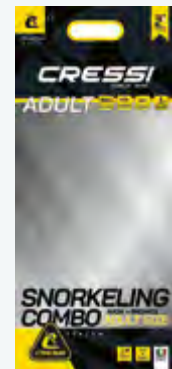

CM 24,5X51,5

/ SNORKELING COMBOS

ONDA + MEXICO

ADULT SIZE

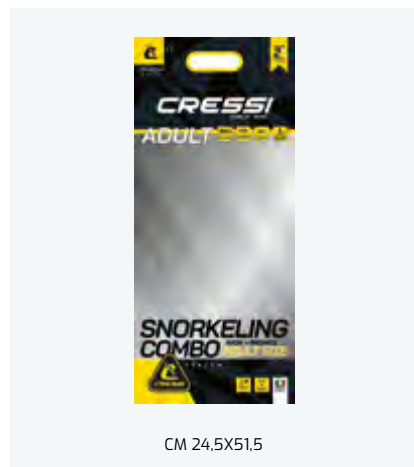
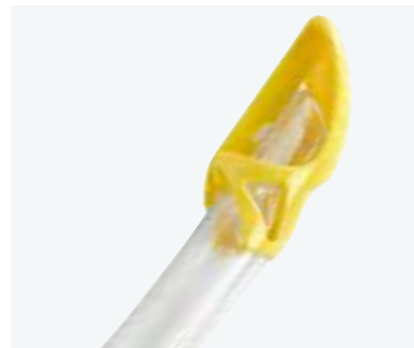

CM 24,5X51,5



CLEAR/YELLOW



CLEAR/BLUE



CLEAR/PINK



CLEAR/AQUAMARINE



BLACK



ASSORTED

PRODUCT	*CASE PACK	CODE	RRP €
ASSORTED	10	DM101015	34,99
CLEAR/YELLOW	10	DM1010151	34,99
CLEAR/BLUE	10	DM1010152	34,99
CLEAR/PINK	10	DM1010154	34,99
CLEAR/AQUAMARINE	10	DM1010153	34,99
BLACK	10	DM1010155	34,99

PERLA + MEXICO

NEW COLOR 2025

ADULT SIZE



CLEAR/BLUE



CLEAR/PINK



CLEAR/BLACK



CLEAR/AQUAMARINE



BLACK

NEW



BLACK



ASSORTED

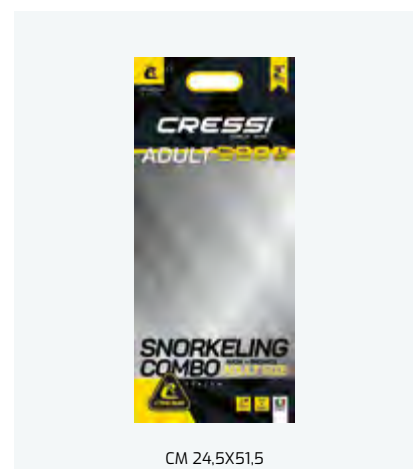

CM 24,5X51,5

PRODUCT	*CASE PACK	CODE	RRP €
ASSORTED	10	DM101017	29,99
CLEAR/BLUE	10	DM101120	29,99
CLEAR/PINK	10	DM101140	29,99
CLEAR/BLACK	10	DM101150	29,99
CLEAR/AQUAMARINE	10	DM101163	29,99
BLACK	10	DM102017	29,99
BLACK/BLUE	10	DM101152	29,99

SIRENA + ISLAND

ADULT SIZE

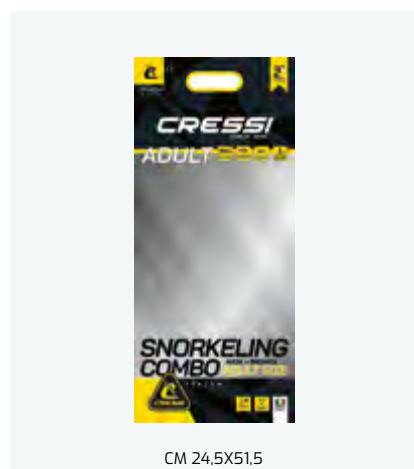

CM 24,5X51,5



CLEAR/AQUAMARINE

BLACK/SMOKED BLACK

PRODUCT	CASE PACK	CODE	RRP €
BLACK	10	DM104150	24,99
CLEAR/ACQUAMARINA	10	DM104125	24,99

MAREA JR + SEAL DRY JR

NEW 2025

AGE 7-13



SNORKELING COMBOS JUNIOR



CLEAR/BLUE



CLEAR/PINK

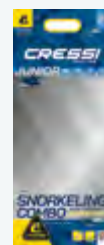

CM 45X15

PRODUCT	CASE PACK	CODE	RRP €
COMBO BLUE	10	DL010022	39.99
COMBO PINK	10	DL010040	39.99

ESTRELLA JR + TOP

AGE 7-13



BLUE

PINK

AQUAMARINE



ASSORTED

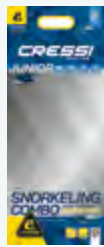

CM 45X15

PRODUCT	*CASE PACK	CODE	RRP €
COMBO BLUE	10	DM350020	39,99
COMBO PINK	10	DM350040	39,99
COMBO AQUAMARINE	10	DM350063	39,99
COMBO ASS. COL.	10	DM351099	39,99

MOON + SEAL DRY JR

NEW 2025

AGE 5-10



BLUE/ORANGE

PINK/WHITE

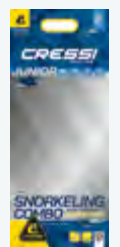

CM 45X15

PRODUCT	*CASE PACK	CODE	RRP €
BLUE/ORANGE	10	DL102802	39,99
PINK/WHITE	10	DL104304	39,99



SKY JR + TOP

AGE 7-13



ASSORTED

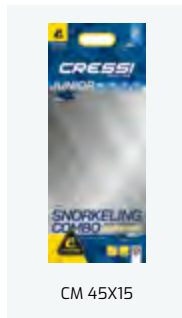

CM 45X15

PRODUCT	*CASE PACK	CODE	RRP €
ASSORTED	10	DM100200	34.99

ONDINA JR + TOP

AGE 7-13



CLEAR/YELLOW



CLEAR/BLUE



CLEAR/PINK



CLEAR/AQUAMARINE

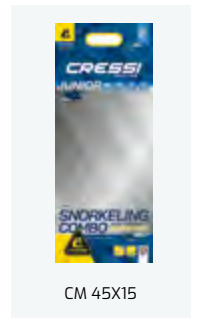

CM 45X15

PRODUCT	*CASE PACK	CODE	RRP €
CLEAR/YELLOW	10	DM1010131	29.99
CLEAR/BLUE	10	DM1010132	29.99
CLEAR/PINK	10	DM1010134	29.99
CLEAR/AQUAMARINE	10	DM1010133	29.99
ASSORTED	10	DM101013	29.99

PERLA JR + MINIGRINGO

AGE 7-13



CLEAR/BLUE



CLEAR/PINK



CLEAR/AQUAMARINE



ASSORTED

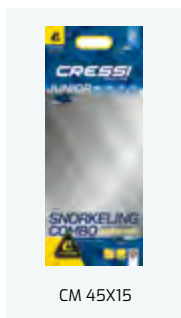

CM 45X15

PRODUCT	*CASE PACK	CODE	RRP €
CLEAR/BLUE	10	DM101220	25,99
CLEAR/PINK	10	DM101240	25,99
CLEAR/AQUAMARINE	10	DM101263	25,99
ASSORTED	10	DM101018	25,99

MOON + TOP

AGE 5-10



BLUE



LIGHT BLUE/LIME



PINK/LILAC

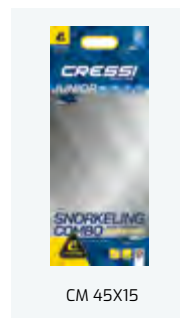

CM 45X15

PRODUCT	*CASE PACK	CODE	RRP €
BLUE	10	DM200620	34,99
LIGHT BLUE/LIME	10	DM200720	34,99
PINK/LILAC	10	DM200740	34,99

SNORKELS



Photo by: Jason Washington

ITACA ULTRA DRY NEW COLOR 2025

DRY GUARD | PURGE VALVE | 100% HIGH QUALITY SILICONE MOUTHPIECE

ADULT SIZE

The features at the top end an internationally patented dry guard, which prevents water entry while using it on the surface in any position. The new mechanical device has three movement joints, whose counterweight ensures immediate opening of the upper valve whether you dive or emerge from the water. The lower part is equipped on the inner side with a smooth flexible corrugated section, which keeps the aerator away from the mouth while using any

breathing apparatus. The mouthpiece, made of soft silicone, has an angle studied in a particularly ergonomic way, with a reduced bite size for prolonged use without gum fatigue. The mouthpiece body consists of two pieces, with an inclination that ensures better and faster water drainage. A lower purge valve enables instant clearing when needed. The transparent tube has a side reinforcement in coloured rubber.

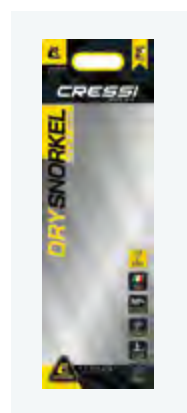

TECHNICAL FEATURES

- Special patented new Aqualstop valve: very efficient on up / down positions
- Dry guard: seals breathing tube when submerged
- Mouthpiece: drops away when not in use - great for scuba divers
- High-quality silicone mouthpiece: is comfortable and durable
- Angled anatomical mouthpiece: reduces jaw fatigue
- Lower purge valve: allows water to be quickly expelled
- Streamlined design reduces drag while swimming
- Adjustable clip for securing to any mask

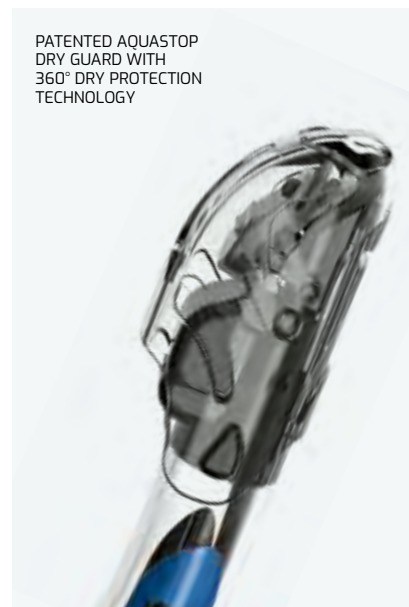

PATENTED AQUASTOP DRY GUARD WITH 360° DRY PROTECTION TECHNOLOGY



QUICK RELEASE SNORKEL HOLDER



PURGE VALVE

COLORS	°CASE PACK	CODE	RRP €
ITACA ULTRA DRY SNORKEL CLEAR/BLACK	6	ES290050	39,99
ITACA ULTRA DRY SNORKEL CLEAR/PINK	6	ES290040	39,99
ITACA ULTRA DRY SNORKEL CLEAR/BLUE METAL	6	ES290020	39,99
ITACA ULTRA DRY SNORKEL CLEAR/AQUAMAR.	6	ES290025	39,99
ITACA ULTRA DRY SNORKEL BLACK/BLACK	6	ES290150	39,99
ITACA ULTRA DRY SNORKEL BLACK/BLUE METAL	6	ES290120	39,99
ITACA ULTRA DRY SNORKEL BLACK/RED	6	ES290158	39,99
ITACA ULTRA DRY SNORKEL BLACK/GOLD	6	ES290109	39,99

ALPHA ULTRA DRY

NEW COLOR 2025

DRY GUARD PURGE VALVE 100% HIGH QUALITY SILICONE MOUTHPIECE

ADULT SIZE

Special snorkel with a special patented "AquaSTOP" valve at the top that keeps water out, making breathing easier and more natural. The tube has an expanded elliptical shape in order to increase comfort and air-delivery capacity. Purge valve and corrugated section near the mouthpiece.



BLUE/AZURE BLACK/SILVER BLACK/YELLOW DARK/YELLOW



BLACK/WHITE BLACK/PINK BLACK/BLACK DARK/WHITE BLUE/BLACK



TECHNICAL FEATURES

- Features a float mechanism which closes instantly to prevent water from entering the snorkel whether accidentally or purposely submerged
- Flexible lower bore reduces jaw fatigue
- Mouthpiece drops away when not in use—great for scuba divers
- High-quality silicone mouthpiece is comfortable and durable
- Angled mouthpiece reduces jaw fatigue
- Lower purge valve allows water to be quickly expelled
- Streamlined design reduces drag while swimming
- Adjustable clip for securing to any mask



DRY GUARD



QUICK RELEASE SNORKEL HOLDER



PURGE VALVE

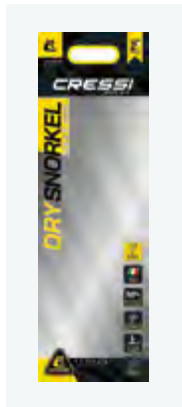

COLORS	*CASE PACK	CODE	RRP €
ALPHA ULTRA DRY SNORKEL SIL. CLEAR/TUBE BLUE AZURE	6	ES258020	34,99
ALPHA ULTRA DRY SNORKEL SIL. CLEAR/TUBE BLACK SILVER	6	ES258055	34,99
ALPHA ULTRA DRY SNORKEL SIL. CLEAR/TUBE BLACK YELLOW	6	ES258051	34,99
ALPHA ULTRA DRY SNORKEL SIL. CLEAR/TUBE BLACK PINK	6	ES258054	34,99
ALPHA ULTRA DRY SNORKEL SIL. CLEAR/TUBE BLACK WHITE	6	ES258053	34,99
ALPHA ULTRA DRY SNORKEL SIL. BLACK/TUBE BLACK	6	ES258150	34,99
ALPHA ULTRA DRY SNORKEL BLACK/WHITE	6	ES258130	34,99
ALPHA ULTRA DRY SNORKEL BLACK/BLUE	6	ES258062	34,99
ALPHA ULTRA DRY SNORKEL BLACK/YELLOW	6	ES258151	34,99

CORFÙ

ADULT SIZE

Snorkel designed mainly for snorkeling, apnea and diving. The tube (curved shape and soft material) has a variable section and in the upper part ends with an innovative splash guard, which drastically reduces water entry from waves, without interfering with breathing. The mouthpiece, made of soft silicone, has an angle studied in a particularly ergonomic way, with a reduced bite size for prolonged use without gum fatigue. The mouthpiece body consists of two pieces, with an inclination that ensures better and faster water drainage. A lower purge valve enables instant clearing when needed.

SPLASH GUARD | PURGE VALVE | 100% HIGH QUALITY SILICONE MOUTHPIECE

TECHNICAL FEATURES

- Profiled splash guard: significantly reduces water entry
- Mouthpiece: drops away when not in use - great for scuba divers
- High-quality silicone mouthpiece: is comfortable and durable
- Angled anatomical mouthpiece: reduces jaw fatigue
- Lower purge valve: allows water to be quickly expelled
- Streamlined design: reduces drag while swimming
- Adjustable clip for securing to any mask

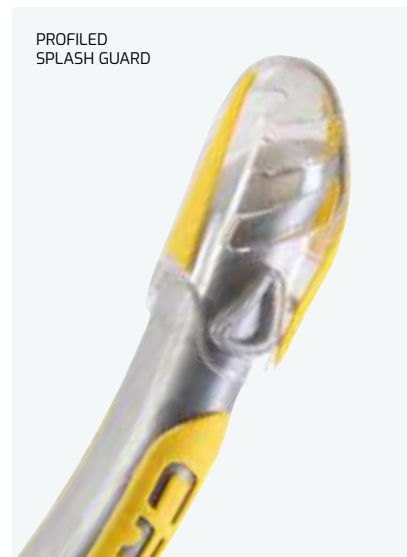

PROFILED SPLASH GUARD



QUICK RELEASE SNORKEL HOLDER



PURGE VALVE

COLORS	°CASE PACK	CODE	RRP €
CORFU SNORKEL SIL. CLEAR/TUBE SILVER AZURE	6	ES300020	29,99
CORFU SNORKEL SIL. CLEAR/TUBE SILVER YELLOW	6	ES300051	29,99
CORFU SNORKEL SIL. CLEAR/TUBE SILVER PINK	6	ES300054	29,99
CORFU SNORKEL SIL. CLEAR/TUBE SILVER BLACK	6	ES300055	29,99
CORFU SNORKEL SIL. BLACK/TUBE BLACK	6	ES300150	29,99

/ SNORKELS

DRY

ADULT SIZE

The dry-top design allows users to take every breath with confidence and focus on the reef below. A float-activated valve instantly seals off the breathing tube if submerged while swimming or from overhead waves. A generous bore provides ample airflow and a lower purge valve enables instant clearing when needed.

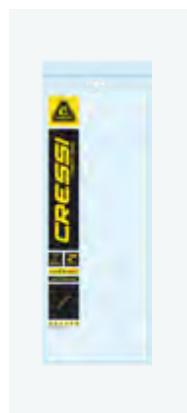

COLORS	*CASE PACK	CODE	RRP €
DRY SNORKEL CLEAR/YELLOW	-	ES259010	37.99
DRY SNORKEL CLEAR/PINK	-	ES259040	37.99
DRY SNORKEL CLEAR/SILVER	-	ES259060	37.99
DRY SNORKEL CLEAR/LIGHT BLUE	-	ES259062	37.99
DRY SNORKEL BLACK/BLACK	-	ES259550	37.99
DRY SNORKEL BLACK/RED	-	ES259558	37.99
DRY SNORKEL BLACK/BLUE	-	ES259520	37.99
DRY SNORKEL BLACK/YELLOW	-	ES259510	37.99

DRY GUARD | PURGE VALVE | 100% HIGH QUALITY SILICONE MOUTHPIECE

TECHNICAL FEATURES

- Dry-top valve seals breathing tube when submerged
- Flexible lower bore reduces jaw fatigue
- Mouthpiece drops away when not in use great for scuba divers
- High-quality silicone mouthpiece is comfortable and durable
- Angled mouthpiece reduces jaw fatigue
- Lower purge valve allows water to be quickly expelled
- Streamlined design reduces drag while swimming
- Adjustable clip for securing to any mask



SEAL DRY

NEW 2025

PATENTED CLOSED-CELL SYSTEM | DRY GUARD | PURGE VALVE | 100% HIGH QUALITY SILICONE MOUTHPIECE

INNOVATIVE CLOSED-CELL FOAM SYSTEM DRY SNORKEL

By introducing the Seal Dry snorkel, Cressi has redefined the concept of comfort and performance. This innovative snorkel features a revolutionary new patented system that stands out from other dry snorkels available on the market. It has been designed by eliminating the reduction of the tube section: this allows you to breathe as if there were no dry system, guaranteeing a fluid and natural flow of air, without compromising user comfort. Another feature of the Seal Dry is its new closed-

cell foam system, an intelligent and effective replacement for the traditional float. During immersion, this system creates an airtight seal that prevents water from seeping into the tube, instead maintaining a constant and facilitated flow of air during immediate emersion. The advanced design makes the Seal Dry ideal for a wide range of diving activities, but it is particularly suitable for freediving and snorkeling. Despite its sophisticated technology, Seal Dry remains versatile and ready

for any situation; it has a large valve for rapid water discharge, ensuring effective cleaning and optimal management of conditions in the water. Cressi's Seal Dry represents the pinnacle of innovation in dry devices for snorkeling and freediving. It offers an unparalleled breathing experience, allowing enthusiasts to dive the seas with confidence and comfort.

TECHNICAL FEATURES

- Revolutionary technology: Constant air flow, hermetic closure
- Smooth breathing
- Optimized performance: Excels in underwater activities
- Suitable for any underwater activity
- Large water outlet valve

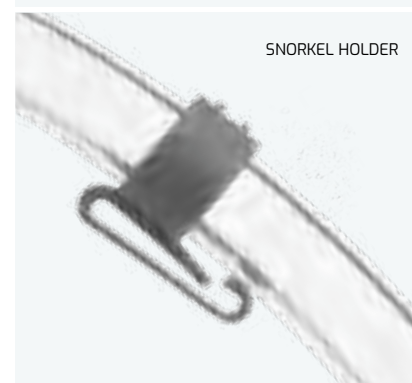
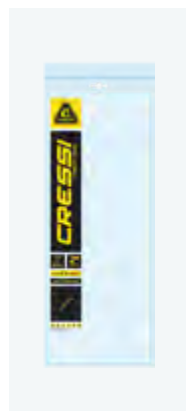

COLORS	*CASE PACK	CODE	RRP €
SEAL DRY SNORKEL CLEAR/BLACK	6	ES330050	24,99
SEAL DRY SNORKEL CLEAR/AZURE	6	ES330022	24,99
SEAL DRY SNORKEL CLEAR/AQUAMARINE	6	ES330025	24,99
SEAL DRY SNORKEL CLEAR/PINK	6	ES330040	24,99
SEAL DRY SNORKEL CLEAR/CLEAR	6	ES330000	24,99
SEAL DRY SNORKEL BLACK/BLACK	6	ES330550	24,99

GAMMA

ADULT SIZE

SPLASH GUARD | PURGE VALVE | 100% HIGH QUALITY SILICONE MOUTHPIECE

Streamlined and compact, the Gamma is easy to *CASE PACK for warm water vacations and an excellent choice for divers and snorkelers who appreciate the confidence and cleanliness of using their own equipment. An upper splash guard drastically reduces water entry from waves, and a clever drainage well collects water that does enter so it can be quickly expelled without interfering with breathing.



COLORS	*CASE PACK	CODE	RRP €
CLEAR/YELLOW	6	EG261010	19,99
CLEAR/BLUE	6	EG261020	19,99
CLEAR/PINK	6	EG261040	19,99
CLEAR/CLEAR	6	EG261060	19,99
CLEAR/AQUAMARINE	6	EG261063	19,99
CLEAR ASSORTED	6	EG261000	19,99
BLACK/BLACK	6	EG261550	19,99

MEXICO

ADULT SIZE

SPLASH GUARD | 100% HIGH QUALITY SILICONE MOUTHPIECE

The Mexico snorkel is a high-end tube specifically studied to form a perfect fit on any face shape and features a completely rounded progressive profile. The upper baffle reduces water entrance due to waves with a design created to avoid damaging the air inlet flow. It has a transparent tube in a very flexible polyurethane with a mixed matte-gloss texture. The section of the tube walls is studied to maintain the necessary stiffness in the pressure zone of the mask strip to support air circulation in this area. It has a very comfortable mouthpiece with a design that combines different thicknesses to favor its self-orientation and relieve the tension of the user's jaw after long use. T



COLORS	*CASE PACK	CODE	RRP €
CLEAR/YELLOW	12	EG269010	12,99
CLEAR/BLUE	12	EG269020	12,99
CLEAR/CLEAR	12	EG269060	12,99
CLEAR/AQUAMARINE	12	EG269063	12,99
BLACK/BLACK	12	EG269550	12,99
ASSORTED	12	EG269000	12,99

CORSICA

ADULT SIZE

CORSICA is a highly technical snorkel designed specifically for deep freediving and spearfishing. The soft bendable large diameter tubing makes it extremely comfortable to properly position behind the head while maintaining ease of breathing on the surface. When diving, the mouthpiece tucks neatly under the chin for the ultimate in hydrodynamics.

The anatomical hypoallergenic silicone mouthpiece provides extreme comfort during long durations in the water. The CORSICA is available in either black or green and is an excellent choice for the discriminating diver who is looking for the best equipment.

100% HIGH QUALITY SILICONE MOUTHPIECE

ULTRA FLEX MATERIAL

TECHNICAL FEATURES

- Anatomical hypoallergenic silicone mouthpiece provides extreme comfort during prolonged use
- Soft bendable snorkel tube to maintain proper and comfortable positioning
- Large diameter snorkel tube provides unobstructed ease of breathing
- Specially designed and molded u-bend provides easier clearing capability
- Ultra flexible tube



BLACK/BLACK

BLACK/GREEN



BLUE METAL

WHITE

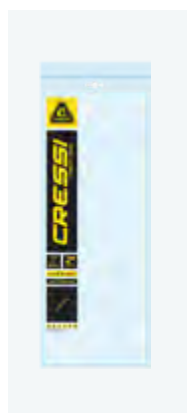
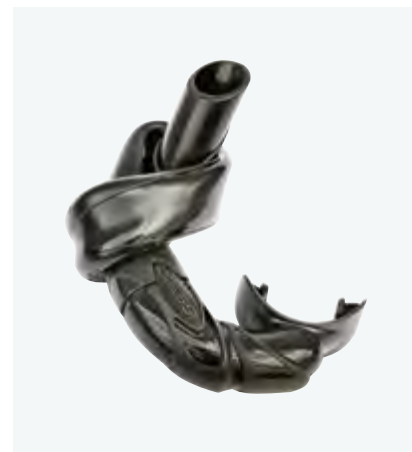

COLORS	*CASE PACK	CODE	RRP €
BLACK/BLACK	12	EG268550	22.99
BLACK/GREEN	12	EG268598	22.99
BLUE METAL	12	EG268555	22.99
WHITE	12	EG268530	22.99

AMERICA

ADULT SIZE

AMERICA is a snorkel specifically designed for deep freediving and spearfishing. This snorkel provides excellent surface breathing properties due to its shorter, large bore flexible tubing with minimal curves to maintain a proper position around the head. The multi-positional soft silicone swivel mouthpiece can be tuned at any angle to provide extreme comfort during long durations in the water.

TECHNICAL FEATURES

- The multi-positional silicone soft mouthpiece provides extreme comfort during prolonged use
- Large diameter Snorkel Tube provides unobstructed ease of breathing
- Minimal tube and mouthpiece bends provides easier clearing capability

100% HIGH QUALITY SILICONE MOUTHPIECE

GRINGO

ADULT SIZE

GRINGO is a traditional snorkel used for all types of diving. This snorkel provides excellent surface breathing properties due to its fairly straight tubing with minimal curves to maintain a proper position around the head. The multi-positional soft silicone swivel mouthpiece can be tuned at any angle to provide extreme comfort during long durations in the water.

TECHNICAL FEATURES

- The multi-positional silicone soft mouthpiece provides extreme comfort during prolonged use
- Large diameter Snorkel Tube provides unobstructed ease of breathing
- Minimal tube and mouthpiece bends provides easier clearing capability



COLORS	*CASE PACK	CODE	RRP €
BLACK/BLACK	12	EG267050	17,99



COLORS	*CASE PACK	CODE	RRP €
BLACK/BLACK	12	EG266000	9,99



Photo by: Ourdays



SEAL DRY JUNIOR

NEW 2025

SMALL SIZE

By introducing the Seal Dry Junior snorkel, Cressi has redefined the concept of comfort and performance. This innovative snorkel features a revolutionary new patented system that stands out from other dry snorkels available on the market. It has been designed by eliminating any reduction of the tube section: this allows you to breathe as if there were no dry system, guaranteeing a fluid and natural flow of air, without compromising user comfort. Another feature of the Seal Dry is its new closed-cell foam system, an intelligent and effective replacement for the traditional float. During immersion, this system creates an airtight seal that prevents water from seeping into the tube. Despite its sophisticated technology, Seal Dry Junior remains versatile and ready for any situation; it has a perfectly sized valve for rapid water discharge, ensuring effective clearing at the surface.

TECHNICAL FEATURES

- Revolutionary technology: Constant air flow, hermetic closure
- Smooth breathing
- Optimized performance: Excels in underwater activities
- Suitable for any underwater activity
- Large water outlet valve
- Innovation and freedom



CLEAR/AZURE CLEAR/PINK CLEAR/CLEAR



CLEAR/AQUAMARINE

COLORS	*CASE PACK	CODE	RRP €
CLEAR/AZURE	6	ES331022	19,99
CLEAR/AQUAMARINE	6	ES331025	19,99
CLEAR/PINK	6	ES331040	19,99
CLEAR/CLEAR	6	ES331000	19,99

MINIDRY

SMALL SIZE

DRY GUARD PURGE VALVE

The MiniDry snorkel has an original anti-splash end with a special valve that seals the tube as you dive, almost totally preventing the entrance of water as the snorkel is submerged. The lower end has a corrugated part that is smooth on the inside and keeps the snorkel away from the mouth when using breathing apparatus. A special water collection cup, with a large elliptic discharge valve makes expelling water quick and easy.

TECHNICAL FEATURES

- Anti-splash end with automatically closing valve
- Ergonomic shape for maximum comfort
- Mouthpiece and corrugated part in hypoallergenic silicone
- Discharge cup for easy and quick emptying



CLEAR/PINK CLEAR/YELLOW
CLEAR/BLUE CLEAR/SILVER



COLORS	*CASE PACK	CODE	RRP €
CLEAR/TUBE PINK	6	ES258840	24,99
CLEAR/TUBE YELLOW	6	ES258810	24,99
CLEAR/TUBE BLUE	6	ES258820	24,99
CLEAR/TUBE SILVER	6	ES258960	24,99



SPLASH GUARD PURGE VALVE

TOP

SMALL SIZE

Sized for optimal comfort and performance for kids, the Top uses the same quality materials as adult snorkels. A splash guard helps reduce water entry and a purge valve below the mouthpiece makes for effortless clearing. The fully adjustable snorkel keeper allows for perfect positioning.

TECHNICAL FEATURES

- Smaller size for young explorers
- Splash guard helps minimize water entry from splashing or waves
- High-quality silicone mouthpiece is comfortable and durable
- Angled mouthpiece reduces jaw fatigue
- Lower purge valve allows water to be quickly expelled
- Adjustable clip for securing to any mask



BLUE PINK GREEN



CLEAR YELLOW CLEAR AQUAMARINE



CLEAR ASSORTED

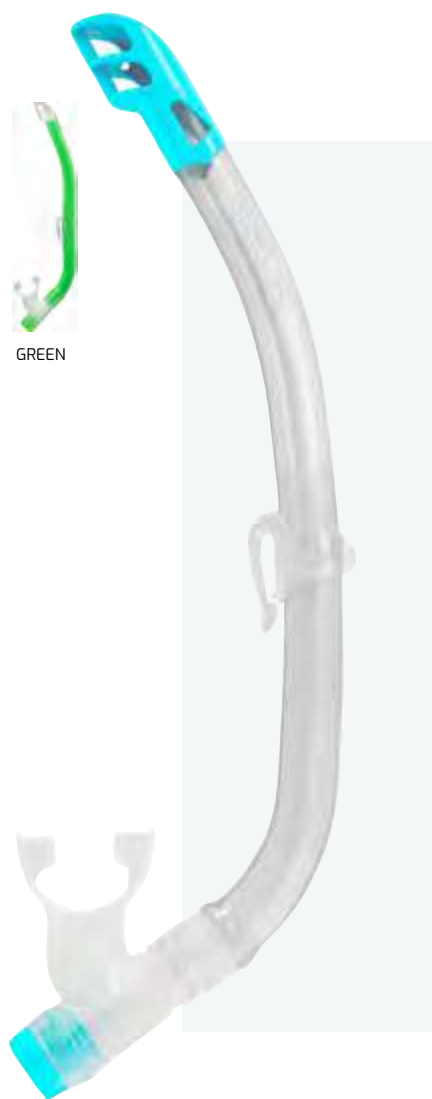

COLORS	*CASE PACK	CODE	RRP €
BLUE	6	ES269120	12,99
PINK	6	ES269140	12,99
GREEN	6	ES269167	12,99
CLEAR/YELLOW	6	ES269010	12,99
CLEAR/AQUAMARINE	6	ES269063	12,99
CLEAR ASSORTED	6	ES269099	12,99



MINIGRINGO

KID SIZE

Smaller version of the Gringo adult snorkel designed for youth boys and girls. The Mini-Gringo is a traditional snorkel for snorkeling and swimming. Flexible, standard bore tube, complete with sliding elastic clip to attach it to the mask. The multi-positional silicone soft mouthpiece provides extreme comfort during prolonged use. Large diameter snorkel tube provides unobstructed ease of breathing. Minimal tube and mouthpiece bends provides easier clearing capability.

TECHNICAL FEATURES

- Standard bore tube
- Keeper: sliding elastic clip
- Multi-positional silicon mouthpiece
- Lightweight



COLORS	*CASE PACK	CODE	RRP €
CLEAR/CLEAR	12	EG265500	9,99

/ SNORKELS SPARE PARTS

SNORKEL KEEPER

BLACK - FOR GRINGO SNORKEL



CODE		RRP €
EZ260003		4,50

SNORKEL KEEPER

FOR AMERICA SNORKEL



CODE		RRP €
EZ267004		4,50

SNORKEL KEEPER

DARK - FOR MEXICO/CORSICA SNORKELS



CODE		RRP €
EZ267005		4,50

SNORKEL KEEPER

GREY - FOR GAMMA AND SEAL SNORKEL



CODE		RRP €
EZ267009		4,50

SNORKEL KEEPER

FOR TOP SNORKEL



CODE		RRP €
EZ267011		4,50

SNORKEL KEEPER

FOR ALPHA ULTRA DRY/ITACA/CORFU SNORKELS



CODE		RRP €
EZ267015		6,50



/ SNORKELS SPARE PARTS

SNORKEL KEEPER

FOR DRY/TAO SNORKELS



CODE		RRP €
EZ267018		6,50

SNORKEL KEEPER

FOR MINIDRY SNORKEL



CODE		RRP €
EZ267019		5,50

SNORKEL MOUTH PIECE

CLEAR - FOR MEXICO/CORSICA



CODE		RRP €
EZ270031		10,99

SNORKEL MOUTH PIECE

BLACK - FOR MEXICO/CORSICA



CODE		RRP €
EZ270029		10,99

SNORKEL MOUTH PIECE

CLEAR - FOR GAMMA SNORKEL



CODE		RRP €
EZ270001		8,99



Photo by: Ourdays



SWIMMING GOGGLES

Photo by: Studio Nicama

/ SWIMMING GOGGLES



Photo by: Studio Nicama



Photo by: Studio Nicama

SKYLIGHT

U.S. PAT 5.956.778 TOTAL VISION MICROMETRIC ADJUSTABLE BUCKLE 100% ANTI UV LENS ANTI SCRATCH LENS ANTI FOG LENS

ADULT SIZE | 180 DEGREES WIDE VIEW SWIM GOGGLES

70 years of mask designs and today's advanced technology comes together in this Cressi masterpiece. We are proud to introduce the best open ocean goggle in the market. It is not only for the serious swimmer. The Skylight has the very best fit

for hours and with wide vision to keep track of the directions which is actually what every swimmer would like to get out of a goggle. If your customers needs the very best goggle in the market, this is what you should get them.



TECHNICAL FEATURES

- Material** 100% Silicone
- Leak proof skirt for a universal fit
 - Perfect for open water and recreational swimming

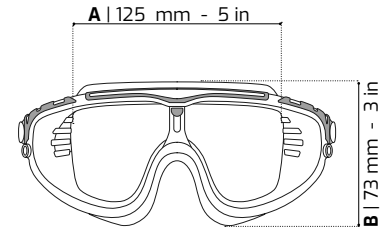

REGULAR



MIRRORED



COLOR	CODE	CASE PACK	RRP €
CLEAR/FRAME BLACK BLUE	DE203320	6	39,99
CLEAR/FRAME WHITE PINK	DE203340	6	39,99
CLEAR/FRAME BLACK LIME	DE203367	6	39,99
CLEAR/FRAME WHITE BLUE	DE203322	6	39,99
CLEAR/FRAME WHITE BLACK	DE203350	6	39,99
SIL/FRAME ASSORTED	DE203399	6	39,99
BLUE METAL	DE203355	6	39,99
BLACK/FRAME BLACK SMOKED LENS	DE203450	6	39,99
BLACK/FRAME WHITE BLACK	DE203451	6	39,99
CLEAR/FRAME BLACK GREY MIRRORED LENS	DE2033750	6	44,99
BLACK/FRAME BLACK GREY MIRRORED LENS	DE2034750	6	44,99



PLANET

ADULT SIZE

Goggles with facial soft silicone which ensures perfect adaptability to a wide range of facial profiles Ideal for swimming, swimming, triathlon and water sports for all Good face seal and great comfort, shatterproof lenses with UV protection and scratch-resistant external

treatment internal anti-fog treatment and extra strong Interchangeable strap instantly with patented buckles with micrometric adjustment and immediate, similar to those of the Cressi-sub diving masks Wide range of colors Special packaging to preserve its characteristics over time.

- U.S. PAT
5.956.778
- TOTAL
VISION
- MICROMETRIC
ADJUSTABLE BUCKLE
- 100% ANTI
UV LENS
- ANTI
SCRATCH LENS
- ANTI
FOG LENS

TECHNICAL FEATURES

- Material** 100% Silicone
- Leak proof skirt for a universal fit
 - Perfect for open water and recreational swimming

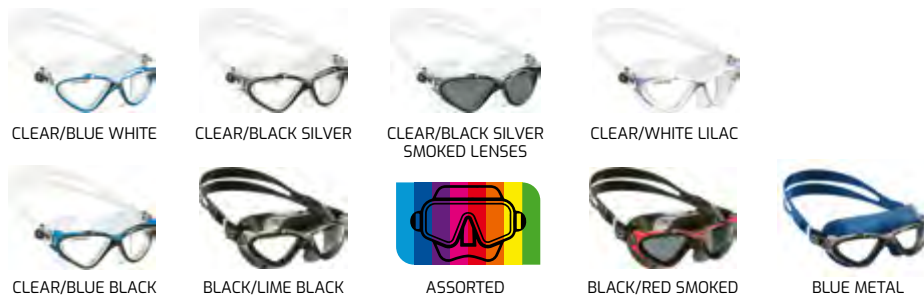
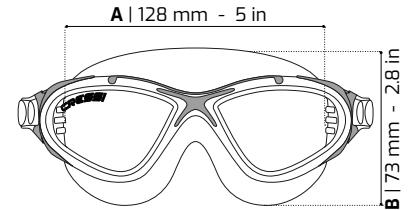

COLOR	CODE	CASE PACK	RRP €
CLEAR/FRAME BLUE WHITE	DE202620	6	34,99
CLEAR/FRAME BLACK SILVER	DE202650	6	34,99
CLEAR/FRAME BLACK SILVER SMOKED LENS	DE202651	6	34,99
CLEAR/FRAME WHITE LILAC	DE202641	6	34,99
CLEAR/FRAME BLUE BLACK	DE202722	6	34,99
BLACK/FRAME LIME BLACK	DE202767	6	34,99
SIL/FRAME ASSORTED	DE202699	6	34,99
BLACK/FRAME RED SMOKED LENS	DE202758	6	34,99
BLUE METAL	DE2026555	6	34,99



U.S. PAT
5.956.778

MICROMETRIC
ADJUSTABLE BUCKLE

100% ANTI
UV LENS

ANTI
SCRATCH LENS

ANTI
FOG LENS

GALILEO

ADULT SIZE | WITH TEMPERED GLASS LENSES

The Galileo goggles have marked a historical turning point in the swimming goggles sector. In actual fact, their flat lenses are mounted on a rigid frame, just like a diving mask, thus guaranteeing perfect vision with no distortion. The shape of the lenses, which are perfectly flat and have no side curving, also prevents annoying distortion at the sides of the lenses.

The watertight seal is extraordinary and comfort is excellent. The strap has a quick adjustment system (Cressi patented), similar to that used on the prestigious Cressi-sub masks, which allows quick and easy adjustment. The shatterproof lenses have external anti-scratch treatment, UV protection and internal anti-fog treatment.

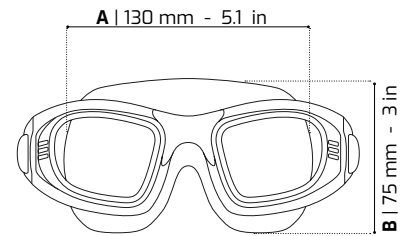

AQUAMARINA



BLUE METAL



WHITE

COLOR	CODE	*CASE PACK		RRP €
T/GLASS SIL/FRAME AQUAMARINA	DE205599	6		39.99
T/GLASS BLUE METAL	DE205055	6		39.99
T/GLASS WHITE	DE205030	6		39.99



REUSABLE PROTECTIVE BOX
13.5X21 CM

COBRA

ADULT SIZE

Goggles with a single-piece skirt that is characterised by the presence of an elastic element within the structure that allows a perfect fit on most facial profiles. Shatterproof lenses with anti-scratch treatment, UV protection and internal

anti-fog treatment. Indestructible, micrometrically adjustable buckles. Possibility of instantly replacing the buckle-strap structure with other models from the Cressi range. Special packaging maintains these characteristics over time.

- U.S. PAT
5.956.778
- TOTAL
VISION
- MICROMETRIC
ADJUSTABLE BUCKLE
- ULTRA CLEAR
VISION
- 100% ANTI
UV LENS
- ANTI
SCRATCH LENS
- ANTI
FOG LENS

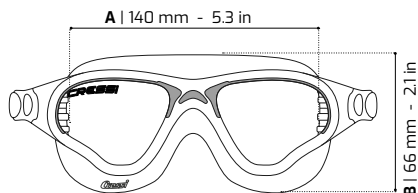

TECHNICAL FEATURES

- Material** 100% Premium TPR
- Leak proof skirt for a universal fit
 - Perfect for open water and recreational swimming



COLOR	CODE	# CASE PACK	RRP €
CLEAR/FRAME CLEAR BLUE	DE201922	6	29,99
CLEAR/FRAME CLEAR BLACK	DE201950	6	29,99
CLEAR/FRAME CLEAR PINK	DE201940	6	29,99
ASSORTED	DE201999	6	29,99
BLACK/FRAME BLACK SMOKED LENS	DE201992	6	29,99
BLACK/FRAME BLACK RED	DE201991	6	29,99





f @ X d in v

CLEAR EYES



PURE SILICONE SWIM GOGGLES WITH MOLECULAR ANTI-FOG LENS TREATMENT «

CARLOS GODOY
 Technical Manager Soft Goods



NEW 2025

WHY BUY IT?

They are designed to offer exceptional comfort and minimize the risk of allergic reactions thanks to the hypoallergenic silicone gasket. They offer crystal-clear visibility in all swimming conditions thanks to the advanced anti-fog treatment of the lenses.

WHAT MAKES IT DIFFERENT?

The seals of the Stream goggles are made of hypoallergenic silicone. The design was based on an avatar with Western facial features, allowing the design of an extremely flexible rubber nose bridge to enhance comfort and fit

WHERE IS THE INNOVATION?

The lenses have a patented clip-on design that reduces the thickness of the frame to a minimum of 1 mm, greatly extending the field of vision. They are also treated with a molecular anti-fog system, making them significantly more fogging-resistant than other models in the Cressi range.



CLEAR EYES

NEW 2025

U.S. PAT
5.956.778

TOTAL
VISION

MICROMETRIC
ADJUSTABLE BUCKLE

ULTRA CLEAR
VISION

GASKET
100% SILICONE

100% ANTI
UV LENS

ANTI
SCRATCH LENS

ANTI
FOG LENS

PURE SILICONE SWIM GOGGLES WITH MOLECULAR ANTI-FOG LENS TREATMENT

Cressi's Clear Eyes swimming goggles are a true masterpiece of technology and design, conceived to offer superior performance compared to other models in the range. The body of the goggles is made of hypoallergenic silicone, chosen for its exceptional comfort and safety, minimizing the risk of allergic reactions during prolonged use. The Clear Eyes' bi-material frame has been carefully designed to ensure an optimal waterproof seal. This frame combines durable and flexible materials to adapt to various face shapes perfectly, resulting in a secure and comfortable fit. The lenses are made with an innovative, patented design by Cressi, featuring a clip fastening system that allows the thickness of the frame to be

reduced to a maximum of 1 mm, considerably widening the field of vision, almost as if the frame had been eliminated. In addition, the Clear Eyes lenses have been subjected to an advanced anti-fog treatment in the laboratory, which makes them significantly more resistant to fogging than other lenses in the Cressi range. This treatment guarantees crystal-clear visibility in all swimming conditions. Furthermore, these lenses have been designed to be more resistant, protecting the eyes from UV rays and shocks. The seals have been designed using an avatar with Western facial features, taking into account the curve of the nose bridge and eye sockets. This makes the flexible rubber nose bridge extremely adaptable; its

flexibility allows the goggles to conform better to the face, increasing comfort and improving the fit, optimizing it for a wide range of users. Like all Cressi products, Clear Eyes goggles feature the micrometric strap adjustment system, a revolutionary design that Cressi introduced, patented and launched on the market over 20 years ago. Perfect for both serious and recreational swimmers looking for the best in terms of comfort, adaptability, and visual performance, Stream goggles are ideal for those who want to push their limits in the water with maximum safety and comfort.



COLOR	CODE	CASE PACK	RRP €
AQUAMARINE/WHITE - CLEAR LENS	ZDE263026	6	39,99
BLACK/GREY - CLEAR LENS	ZDE265055	6	39,99
BLACK/GREY - SMOKED LENS	ZDE2650558	6	39,99
CLEAR/BLUE METAL - CLEAR LENS	ZDE260020	6	39,99
BLACK/RED - CLEAR LENS	ZDE265080	6	39,99
BLACK/BLACK - SMOKED LENS	ZDE2650508	6	39,99
ASSORTED	ZDE260099	6	39,99

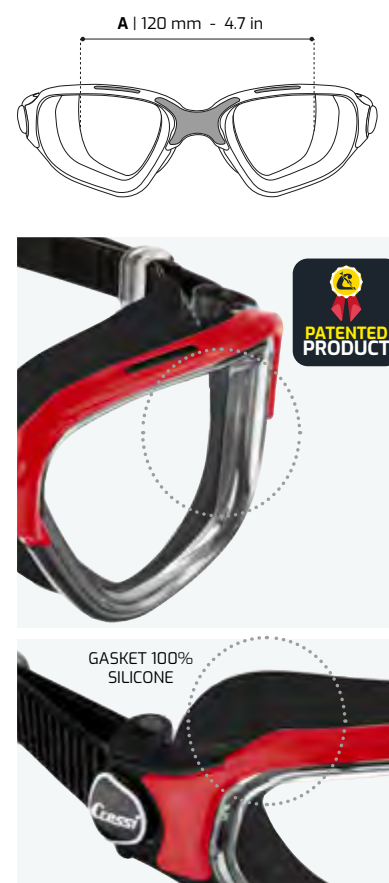

FLASH

ADULT SIZE COMFORTABLE & PERFORMANCE

Flash goggles are characterized by the presence of an elastic element within the structure which allows for perfect adaptability to a large number of facial profiles. Lenses are slightly curved on the outer profile, offering maximum visibility.

Shatterproof lenses with scratchproof treatment and UV protection, as well as internal anti-fogging treatment. Indestructible, micrometrically adjustable buckles. Possibility of instantly replacing the buckle-strap structure with other models from the Cressi range.

FEATURES & SIZE CHARTS

Material 100% Premium TPR

- Leak proof skirt for a universal fit
- Perfect for open water and recreational swimming
- Flexible nose bridge fits various facial profiles

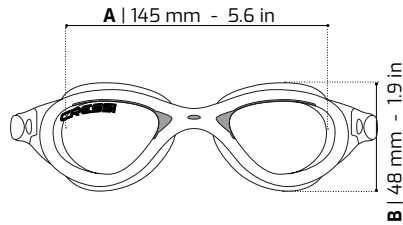

PRODUCT	CODE	*CASE PACK	RRP €
FLASH GOGGLES CLEAR/FRAME CLEAR BLUE	DE202322	6	29,99
FLASH GOGGLES CLEAR/FRAME CLEAR BLUE AZURE LENS	DE202323	6	29,99
FLASH GOGGLES CLEAR/FRAME CLEAR WHITE SMOKED LENS	DE202331	6	29,99
FLASH GOGGLES CLEAR/FRAME CLEAR RED	DE202358	6	29,99
FLASH GOGGLES CLEAR/FRAME CLEAR BLACK	DE202350	6	29,99
FLASH GOGGLES ASSORTED	DE202399	6	29,99
FLASH GOGGLES BLUE/FRAME BLUE WHITE	DE202320	6	29,99
FLASH GOGGLES BLACK/FRAME BLACK GREY SMOKED LENS	DE202392	6	29,99
FLASH GOGGLES BLACK/FRAME BLACK RED	DE202391	6	29,99
FLASH GOGGLES CLEAR/FRAME CLEAR BLUE MIRRORRED LENS	DE2023752	6	34,99

FLASH LADY

ADULT SIZE
COMFORTABLE & PERFORMANCE

- U.S. PAT 5.956.778
- TOTAL VISION
- MICROMETRIC ADJUSTABLE BUCKLE
- ULTRA CLEAR SKIRT
- INCLINED 18° LENSES
- 100% ANTI UV LENS
- ANTI SCRATCH LENS
- ANTI FOG LENS



FEATURES & SIZE CHARTS

- Material** 100% Premium TPR
- Leak proof skirt for a universal fit
 - Perfect for open water and recreational swimming
 - Flexible nose bridge fits various facial profiles

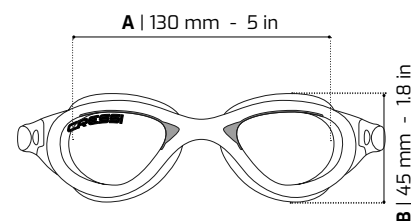

PRODUCT	CODE	*CASE PACK	RRP €
FLASH LADY GOGGLES CLEAR/FRAME CLEAR BLUE	DE203020	6	29.99
FLASH LADY GOGGLES CLEAR/FRAME CLEAR BLACK	DE203050	6	29.99
FLASH LADY GOGGLES CLEAR/FRAME CLEAR WHITE SMOKED LENS	DE203031	6	29.99
FLASH LADY GOGGLES CLEAR/FRAME CLEAR LILAC	DE203041	6	29.99
FLASH LADY GOGGLES CLEAR/FRAME CLEAR PINK	DE203040	6	29.99
FLASH LADY GOGGLES ASSORTED	DE203099	6	29.99
FLASH LADY GOGGLES BLACK/FRAME BLACK GREY SMOKED LENS	DE202950	6	29.99



U.S. PAT
5.956.778

TOTAL
VISION

MICROMETRIC
ADJUSTABLE BUCKLE

INCLINED
18° LENSES

ULTRA CLEAR
SKIRT

100% ANTI
UV LENS

ANTI
SCRATCH LENS

ANTI
FOG LENS

THUNDER

ADULT SIZE | ADVANCED SWIMMER

Swim goggles with separated eyepieces, characterized by an elastic element in the structure that allows the perfect adaptability to most of facial profiles, equipped with slightly curved

lenses on the external side to give the best view. Shatter-proof lenses with anti-scratch treatment, UV rays protection and anti-fog inner treatment. Indestructible clasps with micrometer adjustment.



BLUE



BLACK/BLACK



WHITE/BLUE



LIME



ASSORTED

COLOR	CODE	*CASE PACK		RRP €
THUNDER GOGGLES BLUE	DE203520	6		34,99
THUNDER GOGGLES LIME	DE203567	6		34,99
THUNDER GOGGLES BLACK/BLACK	DE203650	6		34,99
THUNDER GOGGLES WHITE/BLUE	DE203519	6		34,99
THUNDER GOGGLES ASSORTED	DE203599	6		34,99

TECHNICAL FEATURES

Material 100% Premium TPR

- Leak proof skirt for a universal fit
- Perfect for open water and recreational swimming
- Flexible nose bridge fits various facial profiles

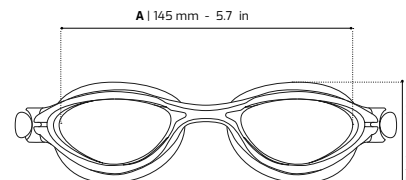

NOSE BRIDGE:
Flexible nose bridge fits various facial profiles



BUCKLES:
Indestructible buckles, with micrometer system adjustment patented by Cressi. Easy to wear

U.S. PAT 5.956.778
Device for regulating the length of a swimming goggles strap



STRAP:
100% High quality silicone



VORTEX

NEW 2025

U.S. PAT
5.956.778

TOTAL
VISION

MICROMETRIC
ADJUSTABLE BUCKLE

100% ANTI
UV LENS

ANTI
SCRATCH LENS

ANTI
FOG LENS

ADVANCED PERFORMANCE

Vortex are innovative swimming goggles designed to offer unparalleled comfort and versatility. Their unique construction is co-moulded with two materials: TPE and a semi-rigid compound for durability and strength. This combination of materials allows perfect adaptability to different facial profiles thanks to the elastic element integrated in the frame. The Vortex lenses are slightly curved on the outside to widen the field

of vision, maximising visibility under water. They are treated against scratches and have an anti-fog inner coating to ensure clear vision in all conditions. Vortex goggles are also equipped with micrometric adjustment buckles patented by Cressi for a long twenty years. These goggles are ideal for swimmers seeking the highest quality and functionality.

FEATURES & SIZE CHARTS

- Leak proof skirt for a universal fit
- Perfect for open water and recreational swimming
- Flexible nose bridge fits various facial profiles



BUCKLES:
Indestructible buckles, with micrometer system adjustment patented by Cressi. Easy to wear

U.S. PAT 5.956.778
Device for regulating the length of a swimming goggles strap



STRAP:
100% High quality silicone



CLEAR/MIRRORED LENS

BLACK/MIRRORED LENS

BLACK/SMOKED LENS

AQUAMARINE/CLEAR LENS

BLUE/CLEAR LENS

BLACK/CLEAR LENS

COLOR	CODE	*CASE PACK		RRP €
CLEAR/MIRRORED LENS	ZDE250009	6		24,99
BLACK/MIRRORED LENS	ZDE255039	6		24,99
BLACK/SMOKED LENS	ZDE255038	6		19,99
BLACK/CLEAR LENS	ZDE255030	6		19,99
BLUE/CLEAR LENS	ZDE252020	6		19,99
AQUAMARINE/CLEAR LENS	ZDE252626	6		19,99



/ SWIMMING GOGGLES

RIGHT

2025 COMEBACK

ADULT SIZE

The Right Goggles feature a classic round lens shape. The lenses are also slightly curved which provides excellent peripheral vision. The TPR gaskets around the lenses form a comfortable, watertight seal around the eye socket. The lenses feature external anti-scratch treatment, UV

protection and internal anti-fog treatment. The headband is made of 100% hypoallergenic silicone for maximum comfort and fit. The strap and buckle is also interchangeable with all other goggles and masks in the Cressi Swim Line.

U.S. PAT
5.956.778

MICROMETRIC
ADJUSTABLE BUCKLE

100% ANTI
UV LENS

ANTI
SCRATCH LENS

ANTI
FOG LENS

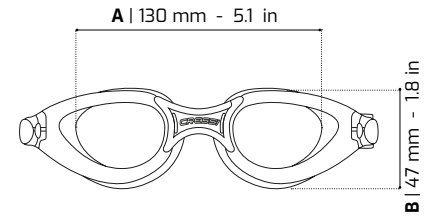

ASSORTED



BLACK/SMOKED LENS



BLACK/SMOKED LENS



BLUE/BLUE



CLEAR/CLEAR



BLUE METAL



BLACK/BLACK

PRODUCT	CODE	*CASE PACK	RRP €
RIGHT GOGGLES BLUE/FRAME BLUE	DE201621	6	24,99
RIGHT GOGGLES CLEAR/FRAME CLEAR	DE201660	6	24,99
RIGHT GOGGLES CLEAR/FRAME CLEAR TINTED LENS	DE201651	6	24,99
RIGHT GOGGLES BLUE METAL	DE2016555	6	24,99
RIGHT GOGGLES BLACK/FRAME BLACK	DE201650	6	24,99
RIGHT GOGGLES BLACK/FRAME BLACK SMOKED LENS	DE201655	6	24,99
RIGHT GOGGLES ASSORTED	DE201699	6	24,99



REUSABLE PROTECTIVE BOX
13.5X21 CM



FOX

ADULT SIZE

The sophisticated design of the Fox Goggles feature uniquely shaped flat lenses which combine fashionable style with perfect vision underwater. The lenses are shatterproof and feature external anti-scratch treatment, UV protection and internal anti-fog treatment.

The Fox goggles feature comfortable TPR gaskets which form a watertight seal on the eyes and fit most facial profiles. The silicone strap and micro-adjustable buckle system are interchangeable with all the other masks and goggles in the Cressi Swim Line.

U.S. PAT
5.956.778

MICROMETRIC
ADJUSTABLE BUCKLE

100% ANTI
UV LENS

ANTI
SCRATCH LENS

ANTI
FOG LENS

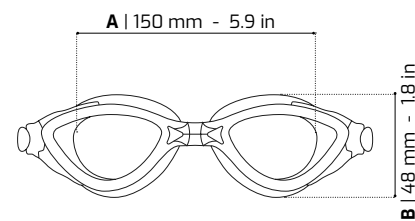

CLEAR



AQUAMARINE



BLACK



ASSORTED

PRODUCT	CODE	*CASE PACK		RRP €
FOX GOGGLES CLEAR/FRAME CLEAR	DE202160	6		19,99
FOX GOGGLES ACQUAMARINA/FRAME AQUAMARINE	DE202163	6		19,99
FOX GOGGLES BLACK/FRAME BLACK	DE202150	6		19,99
FOX GOGGLES ASSORTED	DE202199	6		19,99



/ SWIMMING GOGGLES

NUOTO 3.0

NEW 2025

MICROMETRIC
ADJUSTABLE BUCKLE

3 DIFFERENT
NOSE BRIDGES

ANTI
SCRATCH LENS

ADULT SIZE

The Nuoto 3.0 swimming goggles mark an evolution in the Nuoto series, perfect for leisurely swimming. Designed for adults, these goggles feature a comfortable split silicone strap, with adjustable buckles and

strap holders on each side. The lens shape ensures a secure fit, continuing the Cressi tradition of offering a high-quality product at an affordable price.



YELLOW/BLACK



PINK/CLEAR



NAVY/NAVY



BLACK/BLACK
MIRRORED

PRODUCT	CODE	*CASE PACK		RRP €
NUOTO 3.0 GOGGLES YELLOW/BLACK	ZDE241050	6		11,99
NUOTO 3.0 GOGGLES NAVY/NAVY	ZDE242424	6		11,99
NUOTO 3.0 GOGGLES PINK/CLEAR	ZDE244000	6		11,99
NUOTO 3.0 BLACK/BLACK MIRRORED LENS	ZDE245059	6		11,99

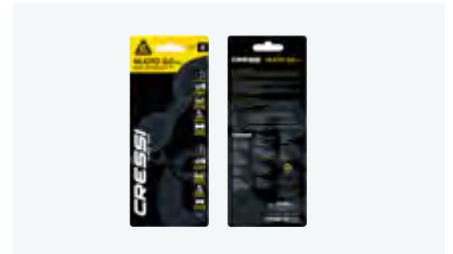

BLISS

NEW 2025

EASY
ADJUSTABLE STRAP

ANTI
SCRATCH LENS

ADULT SIZE

Introducing the Bliss swim goggles, an eagerly anticipated addition to our BLUE by Cressi product line. With its dual eyepiece design for a secure seal and an adjustable silicone strap with

clips on each side, the Bliss offers a timeless, user-friendly goggle suitable for swimmers of all skill levels.



WHITE/AQUA GREEN



WHITE/WHITE



NAVY/NAVY



BLACK/BLACK

PRODUCT	CODE	*CASE PACK		RRP €
BLISS SWIM GOGGLES NAVY/NAVY	ZDE232424	6		9,99
BLISS SWIM GOGGLES WHITE/AQUA GREEN	ZDE233063	6		9,99
BLISS SWIM GOGGLES WHITE/WHITE	ZDE233030	6		9,99
BLISS SWIM GOGGLES BLACK/BLACK	ZDE235050	6		9,99

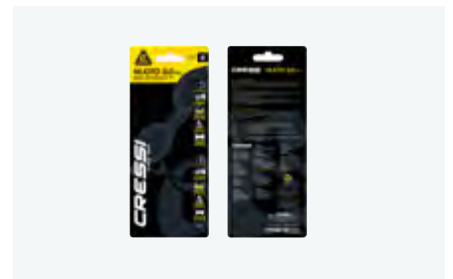

VELOCITY

EASY ADJUSTMENT | UV PROTECTION | HIGH QUALITY

ADULT SWIM GOGGLES

The Cressi Velocity are goggles with separate eyepieces, made from soft thermoplastic materials, with a high standard of quality. The shape of the two eyepieces is highly anatomical, thus ensuring an excellent watertight grip on most face shapes. The lenses are made from shatterproof material that has anti-

fog treatment and UV Ray protection. The strap has buckles for quick and easy adjustment. The Cressi velocity are goggles that have been designed to offer swimming and water sports enthusiasts a product that is of excellent quality and comfort at an affordable price.



COLOR	CODE	*CASE PACK	RRP €
BLACK MIRRORED	XDE206555	3	14,99



Photo by: Studio Nicama

KING BALOO

JUNIOR'S SWIM MASK 7-13 YEARS

This small-size mono lens goggle is perfect for kids, allowing them to swim, snorkel, and play while maintaining excellent watertightness. The reduced skirt design enhances stability on their face, ensuring a secure fit during all activities. With its improved grip capacity, these goggles stay

comfortably in place, providing young adventurers with the confidence to explore underwater. Encourage your kids to become real water enthusiasts with gear that is reliable, comfortable, and easy to use.



BLUE/WHITE

PINK/WHITE

LILAC/WHITE

AQUAMARINE/WHITE

PRODUCT	CODE	*CASE PACK	RRP €
KING BALOO KID GOGGLES BLUE/FRAME WHITE	DE203720	6	27,99
KING BALOO KID GOGGLES AQUAMARINE/FRAME BLUE WHITE	DE203725	6	27,99
KING BALOO KID GOGGLES PINK/FRAME WHITE	DE203740	6	27,99
KING BALOO KID GOGGLES LILAC/FRAME WHITE	DE203741	6	27,99

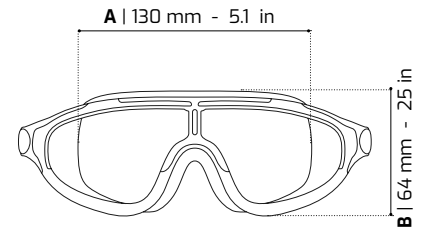

BALOO

KID'S SWIM MASK 3-6 YEARS

- U.S. PAT 5.956.778
- TOTAL VISION
- MICROMETRIC ADJUSTABLE BUCKLE
- ULTRA CLEAR SKIRT
- 100% ANTI UV LENS
- ANTI SCRATCH LENS
- ANTI FOG LENS
- 2-7 YEARS

This extra-small-size mono lens goggle is perfect for kids, allowing them to swim, snorkel, and play while maintaining excellent watertightness. The reduced skirt design enhances stability on their face, ensuring a secure fit during all activities. With its improved grip capacity, these goggles

stay comfortably in place, providing very young adventurers with the confidence to explore underwater. Encourage your kids to become real water enthusiasts with gear that is reliable, comfortable, and easy to use.

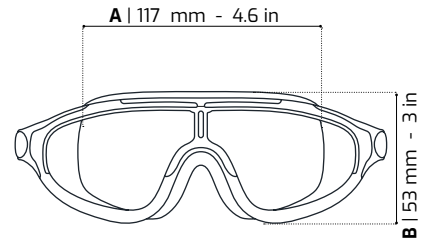

REUSABLE PROTECTIVE BOX 13.5X21 CM



PRODUCT	CODE	*CASE PACK	RRP €
BALOO KID GOGGLES BLUE/FRAME BLUE WHITE	DE203220	6	24,99
BALOO KID GOGGLES PINK/FRAME PINK WHITE	DE203240	6	24,99
BALOO KID GOGGLES LILAC/FRAME LILAC WHITE	DE203241	6	24,99
BALOO KID GOGGLES LIME/FRAME LIME WHITE	DE203267	6	24,99
BALOO KID GOGGLES LIGHT BLUE/LIME	DE203222	6	24,99
BALOO KID GOGGLES ASSORTED	DE203299	6	24,99

MINI COBRA

JUNIOR'S SWIM MASK 7-13 YEARS

Goggles with a single-piece skirt that is characterised by the presence of an elastic element within the structure that allows a perfect fit on most facial profiles. Shatterproof lenses with anti-scratch treatment, UV protection and internal

anti-fog treatment. Indestructible, micrometrically adjustable buckles. Possibility of instantly replacing the buckle-strap structure with other models from the Cressi range. Special packaging maintains these characteristics over time.



ASSORTED

PRODUCT	CODE	*CASE PACK	RRP €
MINI COBRA GOGGLES CLEAR/FRAME LIME	DE202067	6	29,99
MINI COBRA GOGGLES CLEAR/FRAME BLUE	DE202022	6	29,99
MINI COBRA GOGGLES CLEAR/FRAME PINK	DE202040	6	29,99
MINI COBRA GOGGLES LIGHT BLUE/FRAME LIME	DE202021	6	29,99
MINI COBRA GOGGLES CLEAR/FRAME BLUE AZURE LENS	DE202023	6	29,99
MINI COBRA GOGGLES ASSORTED	DE202000	6	29,99

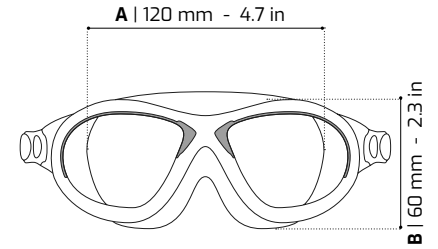

ROCKS

U.S. PAT 5.956.778 | MICROMETRIC ADJUSTABLE BUCKLE | 100% ANTI UV LENS | ANTI SCRATCH LENS | ANTI FOG LENS | 7 - 15 YEARS

JUNIOR'S SWIM MASK 7-13 YEARS

Cressi Rocks are prestigious goggles with slightly curved lenses on the outer profile, to offer maximum visibility. Cressi advanced technology for excellent sealing on most face shapes. Instantly interchangeable strap with patented, immediate,

micrometrically adjustable buckles just like those on the Cressi-sub diving masks. Lenses with external anti-scratch treatment, UV protection and internal anti-fog treatment.

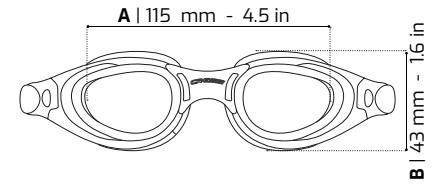

PRODUCT	CODE	*CASE PACK	RRP €
ROCKS KID GOGGLES BLUE/FRAME BLUE	DE201321	6	24,99
ROCKS KID GOGGLES CLEAR	DE201360	6	24,99
ROCKS KID GOGGLES PINK	DE201340	6	24,99
ROCKS KID GOGGLES AZURE	DE201322	6	24,99
ROCKS KID GOGGLES ASSORTED	DE201399	6	24,99



KING CRAB

U.S. PAT
5.956.778

MICROMETRIC
ADJUSTABLE BUCKLE

100% ANTI
UV LENS

ANTI
SCRATCH LENS

ANTI
FOG LENS

7 - 15
YEARS

JUNIOR'S SWIM MASK 7-13 YEARS

The sophisticated design of the King Crab Goggles feature uniquely shaped flat lenses which combine fashionable style with perfect vision underwater. The lenses are shatterproof and feature external anti-scratch treatment, UV protection and internal anti-fog treatment.

The King Crab goggles feature comfortable TPR gaskets which form a watertight seal on the eyes and fit most facial profiles. The silicone strap and micro-adjustable buckle system are interchangeable with all the other masks and goggles in the Cressi Swim Line.

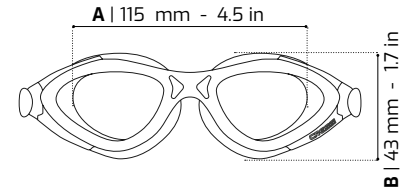

PRODUCT	CODE	*CASE PACK	RRP €
KING CRAB KID GOGGLES PINK/FRAME PINK	DE202240	6	19.99
KING CRAB KID GOGGLES LILAC/FRAME LILAC	DE202241	6	19.99
KING CRAB KID GOGGLES CLEAR/FRAME CLEAR	DE202260	6	19.99
KING CRAB KID GOGGLES BLUE/FRAME BLUE	DE202263	6	19.99
KING CRAB KID GOGGLES ASSORTED	DE202299	6	19.99



U.S. PAT
5.956.778

MICROMETRIC
ADJUSTABLE BUCKLE

100% ANTI
UV LENS

ANTI
SCRATCH LENS

ANTI
FOG LENS

2-7
YEARS

CRAB

KID'S SWIM MASK 3-6 YEARS

Sophisticated silicone goggles specifically designed for children aged approximately between 3 and 7 years. Completely flat lenses for perfect vision even at the edges. Ideal for swim lessons. Shatterproof lenses with UV protection and scratch-resistant external treatment and internal

anti-fog treatment Cressi high technology for a perfect fit on most facial profiles and high comfort. Intercambiabile strap instantly with patented buckles with micrometric adjustment and immediate, similar to those of the Cressi-sub diving masks Boy and Girl version.

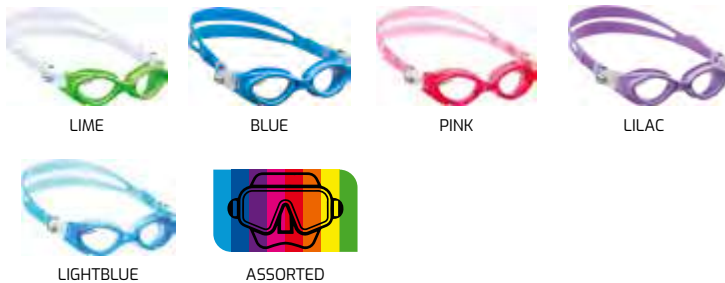
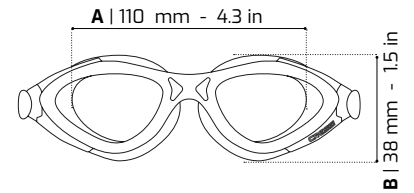

PRODUCT	CODE	*CASE PACK	RRP €
CRAB KID GOGGLES LIME	DE203167	6	19,99
CRAB KID GOGGLES BLUE/FRAME BLUE	DE203122	6	19,99
CRAB KID GOGGLES PINK/FRAME PINK	DE203140	6	19,99
CRAB KID GOGGLES LILAC/FRAME LILAC	DE203141	6	19,99
CRAB KID GOGGLES LIGHT BLUE	DE203120	6	19,99
CRAB KID GOGGLES ASSORTED	DE203199	6	19,99



SEAHORSE

NEW 2025

ANTI-SCRATCH TREATMENT

HIGH QUALITY

HYPOALLERGENIC AND SOFT SILICONE

The Cressi Seahorse is an ideal goggle for younger children. This classic swim goggle features soft silicone gaskets, a split silicone head strap and fog/UV protection. The Seahorse goggles have easy to adjust side clips to ensure a comfortable fit. Ideal for kids aged 4 to 8 years old.

TECHNICAL FEATURES

- Flat lens for ideal vision
- Shatterproof lenses
- Scratch resistant external treatment
- Soft silicone gaskets



GREEN/AZURE

PURPLE/PINK

BLUE/WHITE/RED

GREEN/WHITE/RED

PRODUCT	CODE	*CASE PACK		RRP €
BLUE/WHITE/RED	XDE022038	6		7,99
PURPLE/PINK	XDE023040	6		7,99
GREEN/AZURE	XDE029022	6		7,99
GREEN/WHITE/RED	XDE029038	6		7,99



STARFISH

NEW 2025

ANTI-SCRATCH TREATMENT

HIGH QUALITY

HYPOALLERGENIC AND SOFT SILICONE

The Cressi Seahorse is an ideal goggle for younger children. This classic swim goggle features soft silicone gaskets, a split silicone head strap and fog/UV protection. The Seahorse goggles have easy to adjust side clips to ensure a comfortable fit. Ideal for kids aged 4 to 8 years old.

TECHNICAL FEATURES

- Flat lens for ideal vision
- Shatterproof lenses
- Scratch resistant external treatment
- Soft silicone gaskets

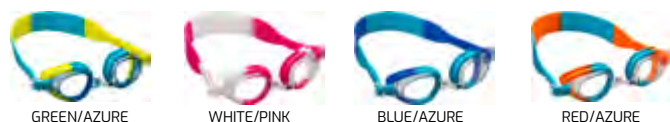

GREEN/AZURE

WHITE/PINK

BLUE/AZURE

RED/AZURE



ASSORTED 24 pcs

PRODUCT	CODE	*CASE PACK		RRP €
BLUE/AZURE	XDE032022	6		6,99
WHITE/PINK	XDE033040	6		6,99
RED/AZURE	XDE038022	6		6,99
GREEN/AZURE	XDE039022	6		6,99
ASSORTED	XDE030024	24		-

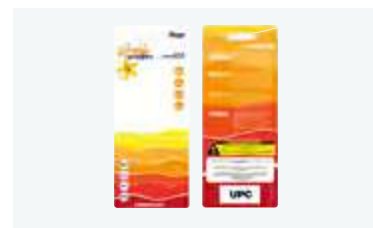

SILICONE STRAP

SWIM EYEWEAR SILICONE STRAP

Made of high-quality silicone, these straps are an original replacement part that ensures maximum reliability. They resist wear and tear caused by chlorinated and salt water, ensuring long, trouble-free service. With an ergonomic design, they offer

superior comfort and a perfect fit during pool or sea sessions. Ensure that your swimming goggles remain reliable and functional over time.

TECHNICAL FEATURES

- For all Cressi swim goggles Adult except: Galileo, Velocity
- Soft Silicone
- High resistance



BLACK



BLUE



GREY



PINK



CLEAR

PRODUCT	CODE	*CASE PACK		RRP €
SILICONE STRAP BLUE	DZ301020	-		5,99
SILICONE STRAP PINK	DZ301040	-		5,99
SILICONE STRAP BLACK	DZ301050	-		5,99
SILICONE STRAP GREY	DZ301051	-		5,99
SILICONE STRAP CLEAR	DZ301060	-		5,99

BUCKLES

BUCKLES FOR SWIM EYEWEAR

Original Cressi replacement buckles for adult swimming goggles are the perfect solution to maintain the performance of your goggles. Made from hard, durable plastic, these wear-resistant buckles come in pairs, ensuring a seamless

replacement process. Designed to fit adult models such as Cobra, Fox, Flash, Flash Lady, Planet and Right, these black buckles integrate perfectly with the silicone buckle.

TECHNICAL FEATURES

- For all Cressi swim goggles Adult except: Skylight, Galileo, Velocity
- Hard plastic
- High resistance



BLACK



CLEAR

PRODUCT	CODE	*CASE PACK		RRP €
BUCKLES STRAP BLACK	DZ300050	-		5,99
BUCKLES STRAP CLEAR	DZ300060	-		5,99



SWIMMING ACCESSORIES



EDDIE

SWIM CAP ADULT

100% SILICONE | HIGH QUALITY

Single color cap in stretch hypoallergenic silicone. Very durable, elastic, is not afraid of aging and the action of chlorine.



INDOOR



BLACK/WHITE

BLACK/YELLOW

BLUE/WHITE

OPEN WATER



LIME/WHITE

ORANGE/WHITE

PINK/WHITE

YELLOW/BLACK



*ASSORTED 20PCS

- BLUE/WHITE X 4 pcs.
- BLACK/WHITE X 4 pcs.
- BLACK/YELLOW X 4 pcs.
- LIME/WHITE X 2 pcs.
- ORANGE/WHITE X 2 pcs.
- PINK/WHITE X 2 pcs.
- YELLOW/BLACK X 2 pcs.



COLOR	CODE	*CASE PACK	RRP €
BLACK/WHITE	XDF223503	10	9,99
BLACK/YELLOW	XDF223501	10	9,99
BLUE/WHITE	XDF223203	10	9,99
LIME/WHITE	XDF223673	10	9,99
PINK/WHITE	XDF223403	10	9,99
ORANGE/WHITE	XDF223853	10	9,99
YELLOW/BLACK	XDF223105	10	9,99
*MEGA PACK ASS.	XDF223000	20	-

LOIRA

SILICONE ADULT SWIM CAP FOR LONG HAIR

NEW 2025

100% SILICONE | HIGH QUALITY

Made from high-quality hypoallergenic silicone, this cap keeps your hair dry while swimming. Loira is resistant to aging and chlorine deterioration, ensuring long-lasting use. Available in three sizes to accommodate different hair lengths, the Loira Swim Cap is specifically designed for individuals with long or very long hair.



BLACK/WHITE

BLUE/WHITE

YELLOW/WHITE

COLOR	SIZE	CODE	*CASE PACK	RRP €
BLACK/WHITE	M	XDF227533	10	12,99
BLACK/WHITE	L	XDF227534	10	12,99
BLACK/WHITE	XL	XDF227535	10	12,99
BLUE/WHITE	M	XDF227233	10	12,99
BLUE/WHITE	L	XDF227234	10	12,99
BLUE/WHITE	XL	XDF227235	10	12,99
YELLOW/WHITE	M	XDF227133	10	12,99
YELLOW/WHITE	L	XDF227134	10	12,99
YELLOW/WHITE	XL	XDF227135	10	12,99

SENNA NEW 2025

100% SILICONE | HIGH QUALITY

PU COATED ADULT SWIM CAP

The Senna Swim Cap for adults is crafted from soft fabric with a PU coating, providing optimal comfort and a snug fit. Its intuitive design makes it easy to put on, saving time and effort before swimming. The ergonomic fit ensures it stays in place without damaging hair. Ideal for those who prefer an alternative to traditional latex or silicone caps, offering both practicality and comfort.



INDOOR



BLACK/WHITE

BLACK/YELLOW

BLUE/WHITE

OPEN WATER



YELLOW/WHITE

ORANGE/WHITE

COLOR	CODE	*CASE PACK	RRP €
BLACK/WHITE	XDF250053	10	9,99
BLACK/YELLOW	XDF250051	10	9,99
BLUE/WHITE	XDF250023	10	9,99
ORANGE/WHITE	XDF250081	10	9,99
YELLOW/WHITE	XDF250013	10	9,99

TAGO NEW 2025

100% SILICONE | HIGH QUALITY

SPANDEX ADULT SWIM CAP

The Tago Swim Cap for adults is made from soft, stretchy fabric, offering optimal comfort and a snug fit. Its intuitive design makes it easy to put on, saving time and effort before swimming. The ergonomic fit ensures it stays in place without damaging hair. Permeable to water, it prevents moisture buildup and dries quickly. Ideal for those who prefer an alternative to traditional latex or silicone caps.



INDOOR



BLACK/WHITE

BLACK/YELLOW

BLUE/WHITE

OPEN WATER



YELLOW/WHITE

ORANGE/WHITE

COLOR	CODE	*CASE PACK	RRP €
BLACK/WHITE	XDF260053	10	7,99
BLACK/YELLOW	XDF260051	10	7,99
BLUE/WHITE	XDF260023	10	7,99
ORANGE/WHITE	XDF260083	10	7,99
YELLOW/WHITE	XDF260013	10	7,99



TAGO JR NEW 2025

SPANDEX JUNIOR SWIM CAP

The Tago JR Swim Cap is designed for junior swimmers, made from soft, stretchy fabric for optimal comfort and a snug fit. Its intuitive design makes it easy to put on, saving time and effort before swimming. The ergonomic fit ensures it stays in place without damaging hair and dries quickly. Ideal for those who prefer an alternative to traditional latex or silicone caps, perfect for young swimmers.



BLUE/AZURE

LIME/BLUE

PINK/WHITE



AZURE/WHITE

AZURE

COLOR	CODE	*CASE PACK	RRP €
AZURE	XDF260122	10	6,99
AZURE/WHITE	XDF260123	10	6,99
BLUE/AZURE	XDF260120	10	6,99
LIME/BLUE	XFD260162	10	6,99
PINK/WHITE	XDF260143	10	6,99

RICKY

SWIM CAP JUNIOR

Single color cap in stretch hypoallergenic silicone. Very durable, elastic, is not afraid of aging and the action of chlorine.



AZURE/WHITE



LIME/BLUE



RED/YELLOW



PINK/PINK



YELLOW/BLUE



*ASSORTED 20PCS

- AZURE/WHITE X 4 pcs.
- LIME/BLUE X 4 pcs.
- RED/YELLOW X 4 pcs.
- PINK/PINK X 4 pcs.
- YELLOW/BLUE X 4 pcs.



COLOR	CODE	*CASE PACK	RRP €
YELLOW/BLUE	XDF224102	10	8,99
AZURE/WHITE	XDF224223	10	8,99
LIME/BLUE	XDF224672	10	8,99
PINK/PINK	XDF224400	10	8,99
RED/YELLOW	XDF224801	10	8,99
*MEGA PACK ASS.	XDF224000	20	-

AQUA ENERGY PRO NEW 2025

SWIM PADDLES

Designed to fit the hands optimally, to improve stroke technique and to develop upper body strength during water activity. The flow holes allow you to feel the flow of the water to improve the feeling. The double-injected material and high-strength elastics give optimal performance during the water activity.

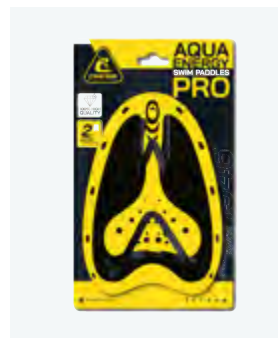

CODE	*CASE PACK		RRP €
DF203151	-		24,99

AQUA ENERGY NEW 2025

SWIM PADDLES

Designed to fit the hands optimally, to improve stroke technique and to develop upper body strength during water activity. The flow holes allow you to feel the flow of the water to improve the feeling.



CODE	*CASE PACK		RRP €
DF203051	-		19,99

SWIM GLOVES

FOR YOUR TRAINING

Webbed gloves for swimming and training. Made in extremely elastic Ultraspan neoprene, they have an external coating on the back, while the palm is made of single-lined neoprene (lined on the internal side) to increase the coefficient of friction with the water, optimizing propulsive output.



COLOR	SIZE	CODE	*CASE PACK	RRP €
BLUE	S	DF200020	3	39,99
BLUE	M	DF200021	3	39,99
BLUE	L	DF200022	3	39,99

DRY EAR PLUG NEW 2025

TRAINING EAR PLUGS

Silicone Ear Plugs prevents water entering while swimming. Made in soft material for ensure comfort. These Ear Plugs are designed to fit in any ear, and attached to an elastic string for easy removal.

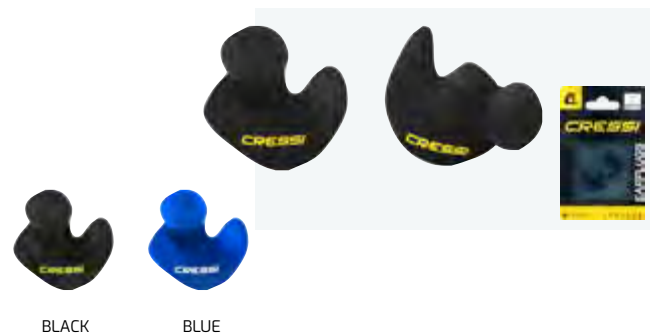

COLOR	CODE	*CASE PACK	RRP €
BLUE	DF202020	10	6,99
BLACK	DF202050	10	6,99

AQUA KIT

NEW 2025

TRAINING NOSE CLIP & EAR PLUGS

Silicone Ear Plugs and Nose Clip prevents water entering while swimming. Made in soft material for ensure comfort. These Ear Plugs are designed to fit in any ear, and attached to an elastic string for easy removal. Includes a small case for easy storage



COLOR	CODE	*CASE PACK	RRP €
BLUE	DF204020	10	11,99
BLACK	DF204050	10	11,99

COMFORT NEW 2025

TRAINING NOSE CLIP

Silicone Nose Clip prevents water entering while swimming. Made in soft material for ensure comfort.



COLOR	CODE	*CASE PACK	RRP €
BLUE	DF201020	10	6,99
BLACK	DF201050	10	6,99





BAGS & BACKPACKS

JUMBO

600-DENIER TWISTED POLYESTER FILAMENT | WATERP REPELLANT MATERIAL | YKK ZIP | PVC LAMINATION | 140 L

WHEELED BAG & BACKPACK

The Jumbo bag is designed for very demanding divers who want to organize transport of all the equipment they need for their dives during their holiday travels or free time. The ample volume (140 liters) and internal partitioning makes luggage easy to prepare. The two side pockets, with the fin logo inside, can hold a pair of large fins, up to size XXL. The two front pockets are handy for packing accessories, like towels, t-shirts and sunglasses. The top pocket protects the two-position telescopic

handle and also conceals a special small pocket inside for a personal details card. The spacious inside compartment has room to organize all technical equipment up to size XXL (e.g. a complete 7 mm hooded wetsuit, jacket, boots, gloves, mask, mouthpiece, regulator, etc.), securing it with two special straps. The system of buckles on the outside allows the bag to be compacted further, by pulling on the straps according to how much is packed in it. The large wheels are highly resistant

and easily replaceable, as they are attached with screws and locknuts. The shoulder straps can be easily concealed in the back pocket and pulled out when needed. The new adjustment buckles on the shoulder straps allow rapid adjustment, even with the bag on the back.



TECHNICAL FEATURES

- Made of 600 Denier twisted polyester fabric, with PVC water-repellent coating
- YKK Zippers
- Adjustable shoulder straps for carrying as a backpack

DIMENSIONS

Volume	140 L
Weight	4,5 kg 10 lbs
Dimensions	80 x 50 x 35 cm 31.5 x 19.7 x 13.8 inch



PRODUCT	CODE	RRP €
JUMBO TROLLEY BAG	UB932500	299,99



SEA HORSE SPECIALIZED

Retailer-Product

NEW 2025

900D/600D-DENIER
TWISTED POLYESTER
FILAMENT

ROLLING BACKPACK

YKK
ZIP | 152 L

VOYAGER ROLLING BACKPACK - IDEAL FOR LIVEBOARD

The Sea Horse rolling backpack is ideal for those looking for practicality and robustness in one. Constructed from 900D/600D polyester fabric, this bag provides excellent strength and durability, making it perfect for use in marine environments and adverse conditions. Equipped with YKK zips, it ensures a secure and reliable closure. One of the distinctive features of the Sea Horse is its ability to be rolled up for easy transport and storage. This makes it particularly useful for boat

travelers, where space is often limited. The bag is also equipped with shoulder straps that, concealed in a dedicated pocket, allow it to be quickly transformed into a backpack, offering unparalleled versatility. Particular attention has been paid to cleanliness and comfort: a small wipe, housed in a special pocket, allows the wheels to be covered when the bag is carried on the shoulders, thus avoiding soiling clothes. In addition, a special pocket is

designed for carrying fins, making the Sea Horse also ideal for snorkeling and diving enthusiasts. With the Sea Horse, every trip becomes a comfortable and stress-free experience, thanks to its clever design and sturdy construction.



TECHNICAL FEATURES

- Strong and durable bag with wheels, made of 900D/600D polyester
- YKK Zippers
- The bag can be rolled up for transport and storage
- Shoulder straps inside their pocket for use as a backpack
- Small towel in its pocket to cover the wheels when carrying on the shoulders, so as not to soil clothes
- Special pocket for carrying fins

DIMENSIONS

Volume	152 L
Weight	3.85 kg 8.5 lbs
Dimensions	81 x 57 x 33 cm 32 x 22.5 x 13 inch



PRODUCT	CODE	RRP €
SEA HORSE VOYAGER ROLLING BACKPACK	UB954000	249,99



MOBY 7

YKK ZIP EXTRA POCKETS 115 L

WHEELED BAG & BACKPACK

Introducing the ultimate travel companion, the Moby 7. Made of durable 450D Ripstop fabric, this trolley offers superior strength and longevity, just like its renowned predecessor, the Moby 5. Front pockets, made of water-repellent material, offer convenient options for storing essentials. The trolley features heavy-duty PVC-coated mesh fabric on the top and bottom sides for exceptional durability. Equipped with heavy-duty wheels, this equipment transport system allows for effortless manoeuvrability. The YKK plastic zip ensures a smooth and reliable closure. For added

convenience, a detachable lower pocket with a concealed hanging strap and thermoplastic side loops for attaching the shoulder strap is included. The inner, lined pocket securely holds the padded shoulder strap. In addition, the Moby 7 has a small front pocket with a semi-dry zip, perfect for storing valuables. As additional equipment, a folding mesh bag with drawstring closure is included, which can be conveniently stored in the small front pocket. The Moby 7 is the epitome of functionality, durability and style for the modern traveller.

DIMENSIONS

Volume	115 L
Weight	4,9 kg 10.8lbs
Main compartment	76 x 40 x 28 cm 30 x 15.8 x 11 inch
Upper front pocket	60 x 91,5 cm 24 x 36 inch



PRODUCT	CODE	RRP €
MOBY 7 TROLLEY BAG	UB932700	279.99

MOBY 5

YKK ZIP EXTRA POCKETS

WHEELED BAG & BACKPACK

It is made from a new 300/400 denier material that is light yet very strong. The main compartment opens on three sides allowing easy access. There are two large bellows pockets to the front with zip closures, two side pockets for fins and a small upper pocket that holds an address tag. There are also two adjustable, padded, straps for carrying on the back that can be placed in special pockets when the backpack is being

forwarded. The reinforced pull handle is telescopic and fully retractable. The wheels have a large diameter and can be removed and easily replaced in the event of breakage. There are two carrying handles: a reinforced one at the top and one with Velcro closure at the bottom. The back of the bag houses supporting rods to keep the Moby 5 in a vertical position. All the zips are very strong YKK.

DIMENSIONS

Volume	115 L
Weight	4,9 kg 10.8 lbs
Main compartment	76 x 40 x 28 cm 30 x 15.8 x 11 inch
Upper front pocket	34,4 x 23 x 8,5 cm 13.5 x 9.05 x 3.3 inch
Lower front pocket	34 x 38 x 8,5 cm 13.4 x 15 x 3.3 inch
Fin pocket	73 x 25 x 7 cm 28.7 x 9.8 x 2.8 inch



PRODUCT	CODE	RRP €
MOBY 5 TROLLEY BAG	UB932200	229,99

MOBY 3

YKK ZIP EXTRA POCKETS 100L

ROBUST AND SPACIOUS WHEELED BAG

Introducing the Moby 3, the little brother of the trolley you know and love. Made of a state-of-the-art 300/400 denier material, this trolley combines a light and attractive design with exceptional durability. The spacious main compartment opens on three sides, providing easy access to your personal belongings. Thanks to the two large side pockets specially designed for fins, you will have ample space to store your belongings. For

comfortable transport, the Moby 3 is equipped with large-diameter wheels, which can be easily changed if necessary. The trolley has reinforced carrying handles at the top and bottom. Like its predecessor, the Moby 3 is equipped with robust YKK zips that guarantee durability. Enhance your travelling experience with the Moby 3.

DIMENSIONS

Volume	100 L
Weight	4,9 kg 10.8 lbs
Main compartment	76 x 40 x 28 cm 30 x 15.8 x 11 inch
Fin pocket	73 x 25 x 7 cm 28.7 x 9.8 x 2.8 inch



PRODUCT	CODE	RRP €
MOBY 3 TROLLEY BAG	UB932600	179,99

MOBY 2 NEW 2025

YKK ZIP EXTRA POCKETS 110L

ROBUST AND SPACIOUS WHEELED BAG

The Cressi Moby 2 is a spacious trolley specifically designed for the transportation of your scuba diving equipment. It boasts dimensions of 85x47x33 cm and a generous capacity of 110 liters. Thanks to its adjustable shoulder straps and robust wheels, the Cressi Moby 2 ensures comfortable and reliable transportation. The trolley is equipped with padded straps that effectively distribute the

weight on your shoulders, providing added comfort during transport. Additionally, the Moby 2 features a convenient drainage system pocket, which is ideal for carrying items that are still wet. As part of the Cressi product range, the Moby 2 is just one of several options available.

DIMENSIONS

Volume	110 L
Weight	2.9 kg / 6.4 lb
Main compartment	85 x 47 x 33 cm 33 x 18 x 13 inch

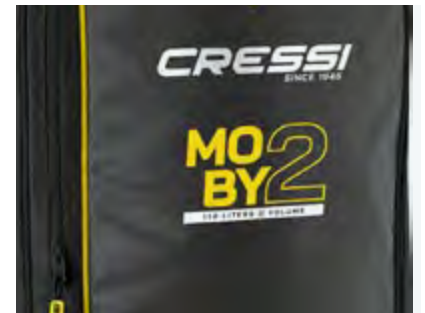

PRODUCT	CODE	RRP €
MOBY 2 TROLLEY BAG	UB932800	149.99

PIPER

ULTRALIGHT TROLLEY | 2.9 KG

The Piper is a suitcase designed and especially convenient for air travel, with a special 2 stage telescoping handle and 2 exterior compression straps with quick-release buckles. Several zippers, heavy-duty wheel housing, bumper protection, and scratch-resistant denier fabric ensure that your equipment will be able to be stored safely. Grab handles on the top, side, and bottom of the suitcase make this very easy to hold. The interior of the Piper features compression straps and a side pocket to help organize your belongings. A back ID

pocket makes it possible to label your suitcase. At 6.4 pounds and 1.73 cubic feet, the Piper is light and great for traveling. Its dimensions are compliance with the carry-on airplane regulations.

IDEAL FOR TRAVEL | 50 L

TECHNICAL FEATURES

Volume	49 L
Weight	2.9 kg 6.4 lbs
Dimensions	35.5 x 23 x 56 cm 14 x 9 x 22 inch



PRODUCT	CODE	RRP €
PIPER TROLLEY BAG	UB952000	149,99

MALPELO

40 L ADVANCED FEATURES BACKPACK

40-liter backpack designed by the Cressi team. It has a double-zip "U" shaped front pocket with a padded compartment for a tablet or large (17") laptop. Interior zippered mesh compartments provide additional organization. Also included is a vertical-zippered front-facing pocket for any documents that need extra protection. Small loops stitched to the exterior outer edge can be used to latch lighter gear. A zippered elastic side-pockets

makes accessing small items easy. There are two carrying handles, one on the top and one on the side, to make carrying easy and comfortable. There are also two shoulder straps, making it possible to wear as a backpack. The straps are padded to provide comfort and reduce stress on the shoulders and back. The bag features a fully adjustable/removable sternum strap to help support the load while being worn as a backpack.

40 L | DOUBLE "U" SHAPED ZIP | INTERIOR COMPARTMENTS

TECHNICAL FEATURES

Volume	40 L
Weight	1,3 kg 2,7lbs
Dimensions	42 x 13 x 61 cm 17 x 5 x 24 inch



PIPER TROLLEY ATTACHMENT STRAP



PIPER + MALPELO



PRODUCT	CODE	RRP €
MALPELO BACKPACK BLACK	UB938000	129,99

/ DUFFLES

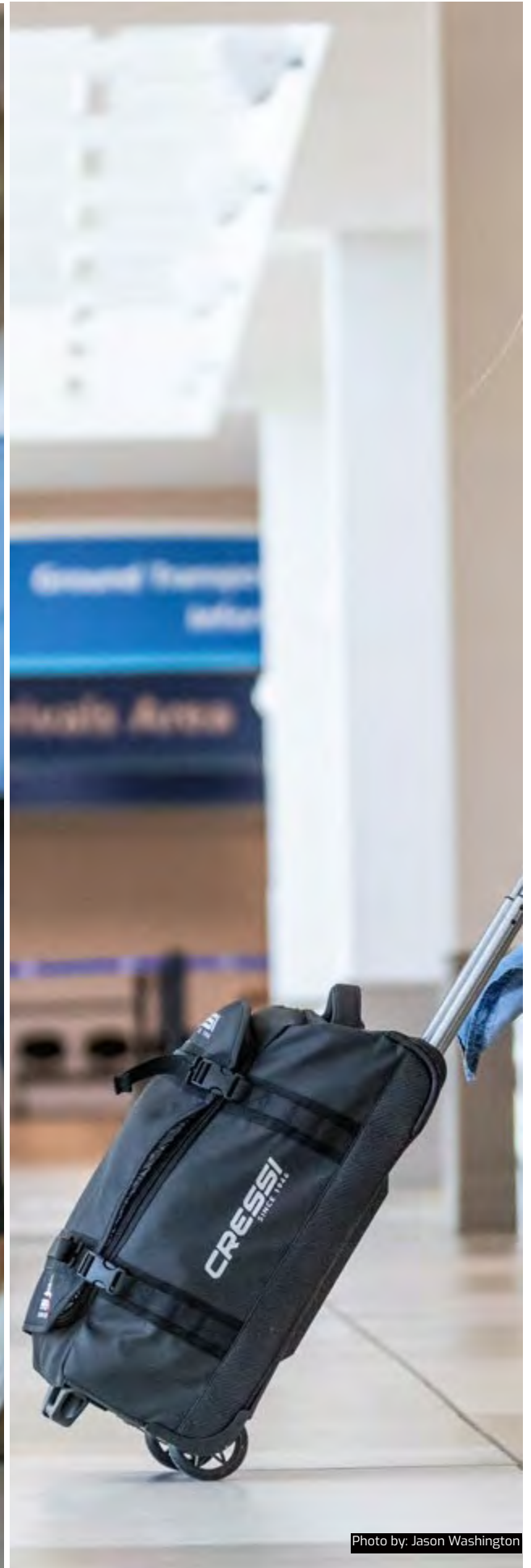

Photo by: Jason Washington

MEGATTERA

YKK ZIP 110 L

DRY DIVING BAG WITH SPECIAL FINS COMPARTMENT

Megattera is a diving bag to carry all your equipment and accessories. It's equipped with handles and adjustable shoulder strap.

Megattera is strong and capacious. It is made of 500 denier tarpaulin, while for the bottom the same material has been used but with an anti-abrasion treatment.

Equipped with a practical upper zipper to easily insert all the accessories and diving equipment, Megattera has two pockets designed especially for divers. The first is external and closed with a buckle, perfect for carrying diving fins; the second pocket is a waterproof internal compartment for carrying equipment and wet clothes.

TECHNICAL FEATURES

- Made of 500 D Tarpaulin
- Diving equipment pockets
- Waterproof internal compartment

DIMENSIONS

Volume	110 L
Weight	2,10 kg 8.48 lbs
Dimensions	83 x 41 x 34 cm 32.7 x 16.2 x 13.4 inch



PRODUCT	CODE	RRP €
MEGATTERA BAG BLACK/YELLOW	XUA926150	119.99



TUNA

WHEELED BAG - FITS LONG BLADE FINS

The Tuna bag has a rigid bottom, thanks to the structure that supports the rubber and anti-breakage wheels. It is designed to carry diving equipment more comfortably. The material is water-repellent, even if not watertight. All metal components are made of rustproof stainless steel. The capacity is 120 litres. It is equipped with

a large internal mesh pocket with zip and a small external pocket with zip. Three inner straps are attached to the bottom of the structure to secure the equipment. At the top end there is a handle for towing and another handle is at the bottom end. In the middle of the bag, two more handles can be joined with a padded strap.

WATERPROOF POLYESTER | EXTERNAL WATERPROOF POCKET | 120 L

TECHNICAL FEATURES

- Waterproof bag
- Made of Polyester
- External pocket
- Side handles and shoulder straps

DIMENSIONS

Volume	120 L
Weight	3,45 kg 7,60 lbs
Dimensions	95 x 40 x 35 cm 37.4 x 15.75 x 13.78 inch



Inside straps



Semi rigid case



With wheels



PRODUCT	CODE	RRP €
TUNA WHEEL BAG BLACK/RED 120LT	XUB976200	199,99

GORILLA PRO

XL SIZE DRY BAG

A large and roomy bag, plenty of space for storage. Internal capacity of 4.75 cu ft (135 liters). The bag is long enough to hold even the long free diving fins. It is made from a strong radio frequency (RF) welded seam PVC and is waterproof. Equipment can be washed with water while still inside the bag.

Once you have finished washing your gear the bag has a special draining cap situated at one end to let water out easily and conveniently. Comes with handy top grab carry handles and two straps that can also be used as shoulder straps. No water comes out when transported, even by car.

135 L | WATER RESISTANT ZIPPER | HIGH FREQUENCY WELDING | FOR GARA FINS

TECHNICAL FEATURES

- High-frequency welding
- Water-resistant zipper
- Special release cap
- Can fit the freediving fins as the Gara

DIMENSIONS

Volume	135 L
Weight	1.6 kg 3.5 lbs
Dimensions	95 x 34 x 42 cm 37.4 x 13.4 x 16 inch



Electronically welded



Special release cap



Zippered external pocket



PRODUCT	CODE	RRP €
GORILLA PRO BAG	UA925710	119.99

GORILLA

XL SIZE HYDRO REPELLENT BAG

A large and roomy bag, plenty of space for storage. Internal capacity of 4.75 cu ft (135 liters). The bag is long enough to hold even the long free diving fins. It is made from a strong radio frequency (RF) welded seam PVC and is waterproof. Equipment can be washed with water while still inside the bag. Once you have finished washing your gear the

bag has a special draining cap situated at one end to let water out easily and conveniently. Comes with handy top grab carry handles and two straps that can also be used as shoulder straps. No water comes out when transported, even by car.

135 L | WATER RESISTANT ZIPPER | HIGH FREQUENCY WELDING

TECHNICAL FEATURES

- High-frequency welding
- Water-resistant zipper
- Special release cap
- Can fit the freediving fins as the Gara

DIMENSIONS

Volume	135 L
Weight	1.5 kg 3.4 lbs



Electronically welded



Special release cap



PRODUCT	CODE	RRP €
GORILLA BAG BLACK/RED	XUA925458	79.99

PIOVRA DRY

LONG BLADE FINS BACKPACK WITH WATER REPELLANT MATERIAL

Cressi's Piovra Dry fin bag is designed for diving and spearfishing enthusiasts. The first compartment, made of 600D polyester with PVC lamination, can hold spearfishing equipment, including wetsuit, long fins (up to 100 cm), bathrobe, etc. In the outer pocket, made of tarred PVC, you can store mask, snorkel, belt, knife, and various accessories. This pocket can also be used to store the catch, thanks to the waterproof

inner lining. Side fastening systems for two rifles, secured by two elastic bands. Side handle. The zip of the main compartment has eyelets for padlocking. The new padded and ergonomic backrest, as well as the shoulder straps, offer more comfort when travelling. The bottom of the backpack is made of 600D polyester with an abrasion-resistant PVC lamination surface, giving your bag more durability.

TECHNICAL FEATURES

- Dry material
- Long fins compartment
- Gun holder



PRODUCT	CODE	RRP €
PIOVRA FINS BACKPACK XL	XVB990250	119.99

DRY GUN BAG

YKK ZIP | 840 DENIER NYLON

DRY BAG FOR SPEARGUNS

A beautiful bag for carrying the spearguns. It features an adjustable shoulder strap and a reinforced handle. It has YKK zip closing long 52.5 in | 133 cm. Inside there is a small pocket with velcro closure. On the top, you can roll and close firmly thanks to the adjustable buckles.

Thanks to the special coating the bag is waterproof and will protect the equipment inside. It is long approximately 70 in (179 cm), enough for carrying long spearguns or other equipment. It is an ideal bag for the spearfishing man that want to protect and easily transport his gear.

TECHNICAL FEATURES

- Waterproof bag
- Made of 840 Denier nylon
- YKK zip closing
- Side handles and shoulder straps

DIMENSIONS

Dimensions 179 x 30.5 x 20 cm
70 x 12 x 7.9 inch

Folding

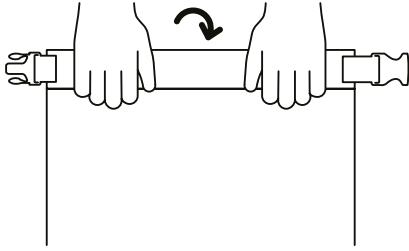

PRODUCT	CODE		RRP €
DRY GUN BAG	UA926200		79.99



ROATAN

HEAVY DUTY MESH BAG 123 L

The Roatan mesh liter bag is perfect to keep all your scuba diving gear together. Made with high-density polyester, this mesh bag makes carrying your gear easy. The bag is equipped with two access points - a drawstring on the top and a full-length zipper on the side - to make retrieving equipment easy, even if wet. The bag can be worn like a backpack, with padded, adjustable shoulder

straps and chest strap. It can also be carried with two reinforced handles, one on the side and one on the top. Included is a semi-dry front pocket with a zipper closure. A drain in the reinforced PVC bottom ensures that any water empties out, making this a perfect option to rinse your gear after use.

123 L MESH BAG FOR DRAINING/RINSING EQUIPMENT MADE WITH HIGH-DENSITY POLYESTER

TECHNICAL FEATURES

- Mesh bag for draining wet equipments
- Made with high-density polyester
- Reinforced PVC bottom
- Back pocket with zip
- Volume: 123 Liters



FULL-LENGTH ZIP



PRODUCT	CODE	RRP €
ROATAN HEAVY DUTY DIVE BAG 123 lt	UB936000	79.99

GORGONA

TRAVEL MESH BAG

Volume	107 L
Weight	0.75 kg 1.65 lbs
Dimensions	38 x 38 x 96 cm 14.96 x 14.96 x 37.79 inch
Materials	70% Polyester Mesh - 30% 600D Polyester PUX2

- Travel mesh bag practical to carry or rinse the equipment
- The length is sized to house even the longest freediving fins
- Bag easily foldable for becoming a practical round bag with handle (diameter 38 cm - 14.96 inch)
- YKK Zippers



PRODUCT	CODE	RRP €
GORGONA BAG BLACK	UA925900	59.99

REGULATOR BAG

The 360 Regulator Bag is a case for protecting scuba diving regulators and octopus. With an adjustable shoulder strap, made of strong nylon. The foam lining acts as a protective covering. The closure is with YKK® zip that ensures a perfect seal.

Dimensions Ø 36 x 11 cm
Ø 14.25 x 4.33 inch



PRODUCT	CODE	RRP €
360 REGULATOR BAG	UB940000	39,99

DRY BOX BLACK

DRY SHELL CASE 110MM

Dimensions

6 x 6 x 11 cm
2.4 x 2.4 x 4.4 inch

Internal Diameter

5 cm
2 inch

- Strong plastic
- Watertight
- Quick closing strap

PRODUCT	CODE	RRP €
DRY BOX BLACK	TA700003	14,99



DRY BOX RED

DRY SHELL CASE 177MM

A strong, plastic, watertight shell that protects valuable small objects when submerged underwater. Once closed the rubber gasket ensures a perfect seal. Equipped with a practical, adjust cord lock for quick adjustments.

- Strong plastic
- Watertight
- Quick cord lock

PRODUCT	CODE	RRP €
DRY BOX RED	TA700080	19,99



DRY GARA

RESISTANT DRY BACKPACK

The Dry Gara Backpack is waterproof, ideal for carrying your equipment comfortably. It is made of durable PVC laminated Tarpaulin heat-sealed by high frequency of 5 tenths of a thickness: almost 100% watertight and, therefore, very practical not to wet the boot of the vehicle.

Adjustable anatomical shoulder straps, with 40 mm straps, adjustable chest strap, and waist strap. Heat-sealed padding. Capacity of 60 liters, ideal for complete equipment adding, also, the longest fins for diving or apnea. Two straps on each side that allow the transport of two spearguns.

- 60 L
- 2 X GUN-HOLDER
- HIGH FREQUENCY WELDING
- FOR GARA FINS

TECHNICAL FEATURES

- Ideal for Gara fins
- High-frequency welding
- 2x gun holder
- 100% Dry Bags

DIMENSIONS

Volume	60 L
Weight	1.12 kg 2.47 lbs
Dimensions	39.5 x 23.5 x 66 cm 15.5 x 9.25 x 26 inch

Folding

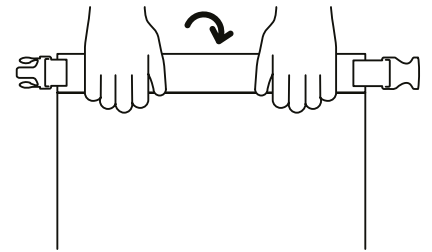

PRODUCT	CODE	RRP €
DRY GARA BAG 60lt	UA925800	79,99



OCTOPUS

DRY BAG, 30 L

Multipurpose bag/backpack in PVC tarpaulin with a 30-L capacity, perfect for sports or travel. Durable and watertight, it keeps your equipment dry and protects your electronic devices. It features side

handles and padded shoulder straps so it's easy to carry. The stitching is made using Seamless technology and is waterproof. Handy rolling top closure with a sturdy quick-release clip fastening.

30 L | WATERPROOF | EXTERNAL POCKETS | ADJUSTABLE SHOULDER STRAPS

TECHNICAL FEATURES

- Waterproof bag/backpack
- Made of PVC tarpaulin
- Seamless stitching technology
- Side handles and padded shoulder straps

DIMENSIONS

Volume	30 L
Dimensions	71 cm x Ø 24 cm 28 x Ø 9.4 inch

Folding Top

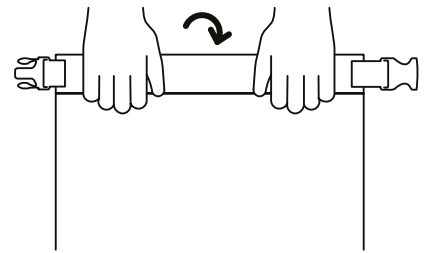

PRODUCT	CODE	RRP €
OCTOPUS DRY BACKPACK BLACK/RED	XUB976000	59,99

VENOM

DRY BACKPACK 30 L

Venom is a rolltop backpack consisting of a watertight PVC tarpaulin compartment for carrying wetsuits and wet gear. A 5-litre compartment is welded to the front, composed of two pockets, one larger and one smaller for wallet and small stuff. The backpack is also equipped with a mesh pocket

for bottles, practical D-Rings on the bottom to hung equipment and let the backpack dry upside down, an elastic bungee cord on the top flap cover to carry out elongated stuff.

30 L | WATERPROOF | ADJUSTABLE SHOULDER STRAPS

TECHNICAL FEATURES

- Waterproof bag/backpack
- Made of PVC tarpaulin
- Seamless stitching technology
- Roll top

DIMENSIONS

Volume	30 L
Dimensions	60.5 cm x 41.6 cm 23.8 x 16.3 inch

Folding Top

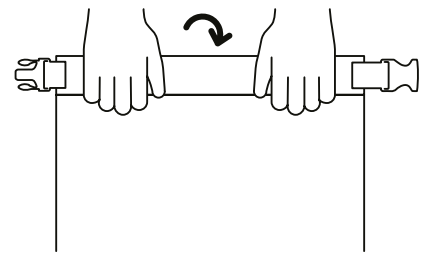

PRODUCT	CODE	RRP €
VENOM DRY BACKPACK	XUB974000	129,99



SPIDY

SUP DRY DECKPACK 25 LITER

Spidy 25L Dry Deckpack born from the desire to create a waterproof backpack that can be comfortably carried on water during paddling activities. Spidy deckpack features adjustable straps with snap hooks, which can be hooked to the D-rings of each SUP boards from our collection.

The backpack is completely waterproof and can be opened and closed in two different ways: from the top side, thanks to the large opening with strap for watertight closure, or from the bottom by the practical dry zip that surrounds the backpack's

structure. The lower hinged opening is especially useful during paddling, when Spidy is fastened at the board, as it lets you easily access the inside of the deckpack without having to unroll the upper opening. The front of the backpack has a bungee rope to storage equipment, while the side has a utility pocket.

The back and the adjustable padded shoulder straps, combined with the chest strap, make the Spidy a practical, comfortable and roomy backpack, ideal for all water activities.

DRY BACKPACK | EASY ISUP ATTACHMENT | ROLLTOP + DRY ZIP CLOSURES | ADJUSTABLE STRAPS

TECHNICAL FEATURES

- Dry backpack
- Rolltop closure + Dry zip bottom
- Sturdy polyester coated PVC fabric
- Seamless stitching technology
- Padded shoulder straps
- 25 L capacity
- External mesh pocket
- Front Bungee cord
- Snap hooks for D-Rings fastening

Box dimensions 50x7x45 cm

Folding Top

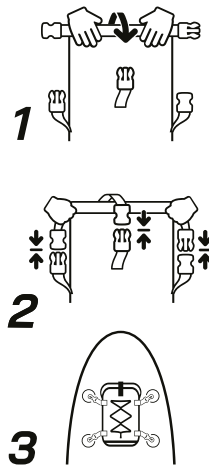

PRODUCT	CODE	RRP €
SPIDY DRY DECKPACK BLACK 25 L	NW022550	119,99



PREMIUM DRY BAG

WITH ZIP, 20 L

Cressi Premium Dry Bag is a waterproof 20 L bag made of high quality PVC. Perfect for scuba diving, fishing, sailing, water sports, and outdoor activities. Fitted with handy removable shoulder straps for

wearing the bag like a backpack and a reinforced side handle to make it easy to carry. Practical and lightweight, it was made to protect your necessary items from the water.

20 L | ADJUSTABLE STRAPS | WATERPROOF | EXTERNAL POCKET

TECHNICAL FEATURES

- 20L waterproof bag
- For all water sports and outdoor activities
- Comfortable removable shoulder straps
- Handy waterproof closure

Folding Top

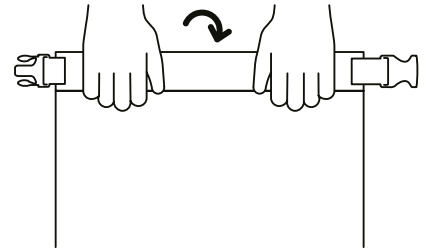

WHITE BLACK BLUE LIGHTBLUE YELLOW ORANGE RED



COLOR	CODE	RRP €
BLACK WHITE	XUA962030	39.99
BLACK BLACK	XUA962050	39.99
BLACK BLUE	XUA962020	39.99
BLACK LIGHT BLUE	XUA962021	39.99
BLACK YELLOW	XUA962010	39.99
BLACK ORANGE	XUA962085	39.99
BLACK RED	XUA962058	39.99

DRY BACKPACK

WATERPROOF | 60 L | ADJUSTABLE SHOULDER STRAPS

DRY BAG, 60 L

Cressi Dry Backpack is a waterproof 60 L bag that's great for protecting items and clothing from sand, soil, water, and snow. To close it, roll it down from the top and fasten the buckle. It is very easy to

transport using the handy shoulder strap. Ideal for carrying your suit, fins, and mask, even when they're wet. Do not submerge the bag! Available in a range of colors.



TECHNICAL FEATURES

- Waterproof Professional Backpack
- Lightweight
- Durable
- Ideal for outdoor water activities
- High quality soft touch material
- 60L capacity

Folding Top

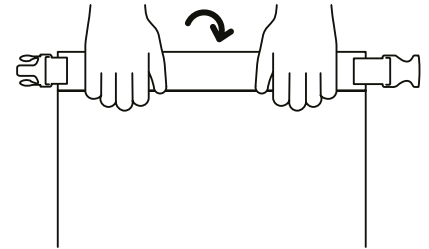

BLACK

ORANGE

BLUE

COLOR	CODE	RRP €
BLACK	XUB965060	64,99
ORANGE	XUB968860	64,99
BLUE	XUB962060	64,99

DRY BAG

WITH ZIP, 10 & 20 L

Cressi Dry Bag is a waterproof bag that's great for protecting items and clothing from sand, soil, water, and snow. To close it, roll it down from the top and fasten the buckle. It is very easy to

transport using the handy shoulder strap. Ideal for carrying your suit, fins, and mask, even when they're wet. Do not submerge the bag! Available in a range of colors.

10 L | 20 L | WATERPROOF | ADJUSTABLE STRAPS

TECHNICAL FEATURES

- Expanded line of models and COLOREs
- Bright COLOREs
- Made of durable PVC
- Hermetic seams
- Handy closure
- Adjustable, removable shoulder strap

Folding Top

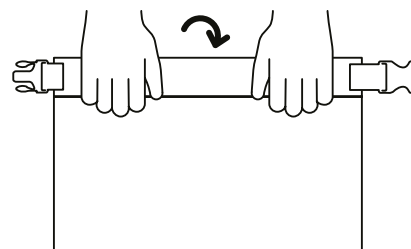

BLACK

ORANGE

BLUE



PRODUCT	CODE	RRP €
DRY BAG BLACK WITH ZIP 10 lt	XUA945010	27,99
DRY BAG BLACK WITH ZIP 20 lt	XUA945020	29,99
DRY BAG BLUE WITH ZIP 10 lt	XUA942010	27,99
DRY BAG BLUE WITH ZIP 20 lt	XUA942020	29,99
DRY BAG ORANGE WITH ZIP 10 lt	XUA948810	27,99
DRY BAG ORANGE WITH ZIP 20 lt	XUA948820	29,99

DRY TEK BAG

ADJUSTABLE
SHOULDER STRAPS

LIGHTWEIGHT
MATERIAL

DRY BAG 20 L

Cressi Dry Bag is a waterproof bag that's great for protecting items and clothing from sand, soil, water, and snow. To close it, roll it down from the top and fasten the buckle. It is very easy to

transport using the handy shoulder strap. Ideal for carrying your suit, fins, and mask, even when they're wet. Do not submerge the bag! Available in a range of colors.



TECHNICAL FEATURES

- Top buckle and shoulder strap
- Shoulder strap carabiner fastens to the loop
- Made of durable PVC
- Hermetic seams
- Handy closure
- Adjustable, removable shoulder strap

Folding Top

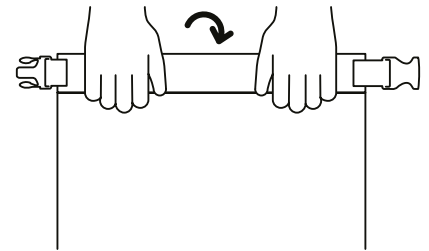

BLACK

ORANGE

PRODUCT	CODE	RRP €
DRY TEK BAG BLACK 20 LT	XUA955020	24,99
DRY TEK BAG ORANGE 20 LT	XUA958820	24,99

DRY BAG

SHOULDER STRAP

Cressi Dry Bag is a waterproof bag that's great for protecting items and clothing from sand, soil, water, and snow. To close it, roll it down from the top and fasten the buckle. It is very easy to

transport using the handy shoulder strap. Ideal for carrying your suit, fins, and mask, even when they're wet. Do not submerge the bag! Available in a range of colors.

5 L | 10 L | 15 L | 20 L | WATERPROOF | ADJUSTABLE STRAP

TECHNICAL FEATURES

- Expanded line of models and COLORES
- Bright colors
- Made of durable PVC
- Hermetic seams
- Handy closure
- Adjustable, removable shoulder strap

Folding Top

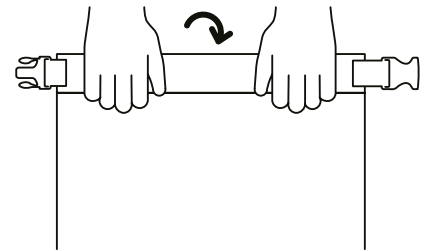

*MEGA PACK ASSORTED BLACK-BLUE 12XPCS.

- BLUE 10 LT X 3 pcs.. **NEW**
- BLUE 20 LT X 3 pcs..
- BLACK 10 LT X 3 pcs..
- BLACK 20 LT X 3 pcs..



LT	BLACK	WHITE	BLUE	LIGHT BLUE	PINK	RED	ORANGE	*CASE PACK		RRP €
5	XUA928901	XUA928301	XUA928201	XUA928601	XUA928401	XUA928101	XUA928801	-		19,99
10	XUA928910	XUA928310	XUA928210	XUA928610	XUA928410	XUA928110	XUA928810	-		21,99
15	XUA928905	XUA928305	XUA928205	XUA928605	XUA928405	XUA928105	XUA928805	-		24,99
20	XUA928920	XUA928320	XUA928220	XUA928620	XUA928420	XUA928120	XUA928820	-		27,99
*MEGA PA.	XUA928000	-	XUA928000	-	-	-	-	12		-

KOALA

NEW 2025

ADJUSTABLE STRAP

LIGHTWEIGHT MATERIAL

WATER REPELLENT WAIST BAG

Designed for seamless functionality in your daily adventures. Crafted from sturdy, durable outer material, it withstands the hustle of everyday life with ease. Boasting four convenient pockets - a spacious main compartment, discreet back hidden pocket, secure inner zipper pocket, and a frontal small pocket - it ensures effortless organization

of your essentials. The integrated inner keychain keeps keys within reach at all times. Constructed from water-resistant material, it shields your belongings from unexpected drizzles. A smooth zip guarantees easy access, while durable buckles provide a secure closure.

TECHNICAL FEATURES

- 4 pockets
- Inner keychain
- Water repellent coating treatment
- Smooth zip
- Durable Buckles

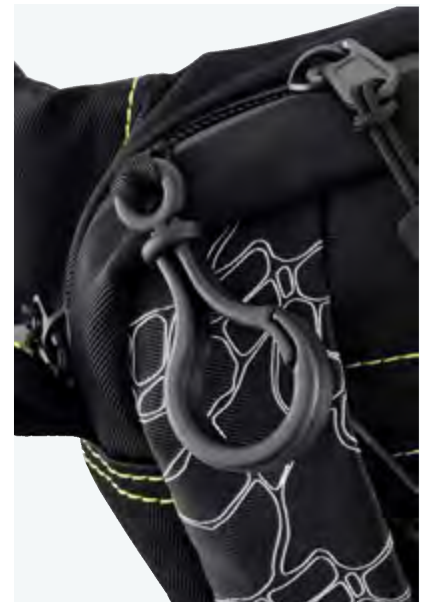

BLACK



BLUE

PRODUCT	CODE	RRP €
KOALA POUCH BLUE	XUB990020	39,99
KOALA POUCH BLACK	XUB990050	39,99

KOALA SPORT

NEW 2025

ADJUSTABLE STRAP

LIGHTWEIGHT MATERIAL

WATER REPELLENT WAIST BAG

Crafted from robust, durable outer material, it's built to endure the demands of any adventure. With three pockets - a spacious main compartment, discreet back hidden pocket, and secure inner zipper pocket - organization is effortless. The integrated inner keychain ensures you'll never misplace your keys again. Constructed from water-

resistant material, it shields your essentials from the elements. A smooth zip ensures easy access, while durable buckles provide a secure closure.

TECHNICAL FEATURES

- 3 pockets
- Inner keychain
- Water repellent coating treatment
- Smooth zip
- Durable Buckles



BLACK



BLUE



PRODUCT	CODE		RRP €
KOALA SPORT POUCH BLACK	XUB991050		29,99
KOALA SPORT POUCH BLUE	XUB991020		29,99

KANGAROO

PROTECTIVE POUCH

Cressi Kangaroo is a water-resistant pack/bumbag in high-quality PVC. Perfect for beach, boating and outdoor activities. Practical and lightweight, it

features a handy closure. It protects your devices and documents from water drops and sand dust.

SPLASH-PROOF PROTECTION FROM THE WATER

TECHNICAL FEATURES

- Water resistant pack/bumbag
- Perfect for beach, boating and outdoor activities
- Handy closure
- It protects your devices and documents from the water



BLACK

DARK BLUE

LIGHT BLUE

PINK

COLOR	CODE	*CASE PACK	RRP €
BLACK	XUB980030	3	14,99
DARK BLUE	XUB980060	3	14,99
LIGHT BLUE	XUB980040	3	14,99
PINK	XUB980010	3	14,99





FLOAT CASE & FLOAT CASE MAX

BUOYANCY UP TO 200 GRAMS
IPX7
WATERPROOF

NEOPRENE ARMBAND INCLUDED
ROLLTOP + DRY ZIP CLOSURE

FLOATING DRY PHONE CASE 6" & 7"

Float Case is the floating waterproof phone case from Cressi Hydrosports collection. Available in two different dimensions, is designed to fit smartphones with screens up to 6" and 7", and a maximum weight of 200 g. The inner foam frame is designed to let you take photos from both camera of any phone, thanks to his closed cell material it prevents your smartphone from sink and absorbs the shocks from accidental fallings

Float Case allows excellent interaction with touch screens function and does not impede during voice calls. The waterproofness feature is ensured by the rolltop velcro closure and the inner pressure lock zip, tested to IPX7 standard with no ingress of water result. Float Case is equipped with a practical adjustable neck cord and soft neoprene arm band.

TECHNICAL FEATURES

- Waterproof IPX7 phone case
- Floating case, weight up to 200 g
- Rolltop velcro closure + dry zip
- Semi-rigid structure
- Touchscreen function supported
- Suitable for device with screen up to 6" and 7"
- Neoprene armband and neck cord included

Folding Top

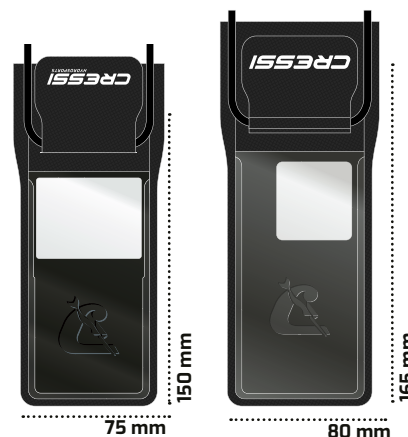
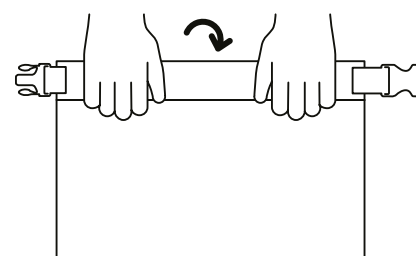

Box dimensions 11x4x20,5 cm

Box dimensions 11,8x4x22,5 cm

PRODUCT	CODE	RRP €
FLOAT CASE FLOATING DRY PHONE CASE BLACK 6"	NW200650	29,99
FLOAT CASE FLOATING DRY PHONE CASE BLACK 7"	NW200750	34,99

JIMMY

DRY PHONE CASE SAND PROOF

SOFT WATER RESISTANT MOBILE PHONE CASE 7"

The Jimmy case is designed to protect your device from water and sand. Its dual press-fit zipper and roll-top closure provides an airtight seal that prevents the entry of liquids and debris while offering protection from the elements. Mantle is ideal for protecting your phone during outdoor and

water activities, giving you peace of mind that your device is safe from damage from liquids and dust.

TECHNICAL FEATURES

- Waterproof
- Transparent, doesn't affect the photographic effect
- Button closure
- Softmaterial



BLACK AZURE YELLOW TURQUOISE

COLOR	CODE	*CASE PACK		RRP €
BLACK	NW200150	10		9,99
YELLOW	NW200110	10		9,99
TURQUOISE	NW200128	10		9,99
BLUE	NW200122	10		9,99

JOHNNY

HARD TOP WATER RESISTANT MOBILE PHONE CASE 7"

DRY PHONE CASE SAND PROOF

Jhanny, is our waterproof soft case for the sea with a large transparent window. Ideal for water and photography enthusiasts, this case protects your device from the marine elements during your water activities. The generous transparent window allows you to take great photos without having to remove your device from the case. You can capture breathtaking seascapes and immortalise your favourite moments without

worrying about water and sand seeping in. The cover retains the touchscreen functionality of your device, allowing you to use all its functions without restrictions. You can answer messages, browse social media or listen to your favourite music, all while your device is safe inside the case. The lightweight and compact design makes it easy to carry wherever you go, taking up little space in your luggage. Protect your device and unleash your photographic creativity without worries.

TECHNICAL FEATURES

- Waterproof
- Transparent, doesn't affect the photographic effect
- Ermetic closure
- Hard material



BLACK



BLUE

COLOR	CODE	*CASE PACK	RRP €
BLACK	NW200250	10	14,99
BLUE	NW200220	10	14,99

BUOYS



Photo by: James Muir

SIGNAL BOARD BUOY

PVC WITH MESH COVER + 0.25 MM INNER BLADDER | 20 M LINE | CARRYING HANDLE | FLAG WITH 40 CM POLE | 4 POCKETS | SAFETY WHISTLE

Red for excellent visibility, it uses two casings: an outer skin made of abrasion-resistant material ensures excellent protection for the two inner inflatable chambers, which are white. A mesh cover makes the bottom abrasion-proof and ensures effective drainage so that the buoy retains its light weight at all times. The upper part is fitted with multipurpose pockets and a big expanding container. A mesh bag made of adjustable elastic straps will carry additional objects. A zipper along the centre gives access to the two air tubes, which are kept separate for fail-safe buoyancy. A casing for the pole of the flag required by regulations is provided in the centre of the front section of the float. Also Red, the line is about 20m long and is fitted with two plastic snap hooks. This buoy comes with a convenient whistle: an additional safety device.



PRODUCT	CODE		RRP €
SIGNAL BOARD BUOY	TA611902		99,99

SPYDER BOARD BUOY

BRIGHT RED COLOR FOR MAXIMUM VISIBILITY | FLAG WITH 40 CM POLE | 4 POCKETS

The buoy is double chamber type with an inner tube and an external protective cover. It is made from abrasion-resistant 420D nylon. Fluorescent red colour makes it highly visible. Holds 3 rifles. Buoy dimensions: 80 cm x 30 cm. The buoy has a double internal chamber to increase your safety. If one is pierced, the buoy will always be on the surface thanks to the other chamber. The three pockets are very practical for storing various accessories. A stabilising lead makes this buoy very stable even with the sea formed and with the top compartments occupied by heavy objects.



PRODUCT	CODE		RRP €
SPYDER BOARD BUOY	TA611900		79,99

TORPEDO BUOY

BRIGHT RED COLOR FOR MAXIMUM VISIBILITY CLASSIC TORPEDO SHAPED BUOY 0.35 MM PVC

The PVC used for this mono-camera buoy is very thick (0.35 mm) and is highly resistant to stress from sea activities. High-quality heat welded connections. The torpedo shape is very convenient for swimming because it eliminates any hydrodynamic resistance. It has a super slip tray finish, so that the buoy is the minimum resistance to the angler's progress. It is also very comfortable for rifles that can be positioned lengthly. Pole with "Diver Underwater" flag and 25 m rope.

Diameter	25 cm - 9.85 inch
Height	85 cm - 33.46 inch
Volume	about 15 L
Weight	680 gr - 1.5 lb



PRODUCT	CODE		RRP €
TORPEDO BUOY	TA611600		24,99

COMPETITION BUOY

BRIGHT RED COLOR FOR MAXIMUM VISIBILITY CLASSIC ROUND BUOY 0.35 MM PVC

This spherical float is slightly flattened to offer less wind resistance and has a built-in inflatable flag. Made from PVC, it has a strong anchor point for attaching the line on the lower half. It is supplied complete with a light 25 m floating line that has a small cylindrical lead weight of 150 g.

Diameter	30 cm - 11.81 inch
Height	23 cm - 9.05 inch
Volume	about 7 L
Weight	380 gr - 0.84 lb



PRODUCT	CODE		RRP €
COMPETITION BUOY	TA611500		29,99

SWIM BUOY

FOLDING TOP CLOSURE INFLATION VALVE

Very hydrodynamic Swim Buoy, realized with quality materials and components. Tapered design that improves the hydrodynamics especially in case of blurred sea and wind. Red orange fluorine fabric for great visibility. Brilliant finish for an ideal slide. Internal compartment watertight with water tightness system specially effective with rigid soul. Inflator with safety closing screwing.

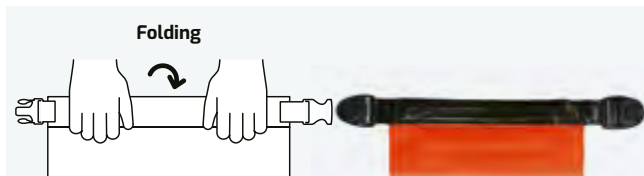

PRODUCT	CODE		RRP €
SWIM BUOY	TA611981		49,99



Photo by: Wojciech Dopierala

FREEDIVING BUOY

NEW 2025 PRODUCT UPDATE

BRIGHT RED COLOR FOR MAXIMUM VISIBILITY CLASSIC ROUND BUOY 0.35 MM PVC

This training buoy is dedicated to freediving. It has a durable external material, an external zipper pocket, four external handles for pre-immersion preparation and two exterior D-rings. The wide interior space allows to store the rope during transport. The inflation system is oral with overpressure valve. The freediving rope can be connected to a D-ring in stainless steel. Flag is included.



PRODUCT	CODE		RRP €
FREEDIVING TRAINING BUOY	TA611991		179.99



ELITE MARKER BUOY

The Elite Marker is a brightly coloured open-cell buoy designed for divers seeking reliability and practicality. Equipped with a plastic wind inflator and an open end for inflation via the diver's octopus, this buoy guarantees ease of use. It can be easily attached to a finger reel and deployed from below or at the surface; it has reflective strips on the top for easy identification. Deflation is quick and easy, thanks to the quick release valve, which also prevents over-inflation upon release from depth. The buoy can be stowed away thanks to the attached bungee and fits comfortably in most divers' pockets.



PRODUCT	CODE		RRP €
ORANGE	TA611828		59.99

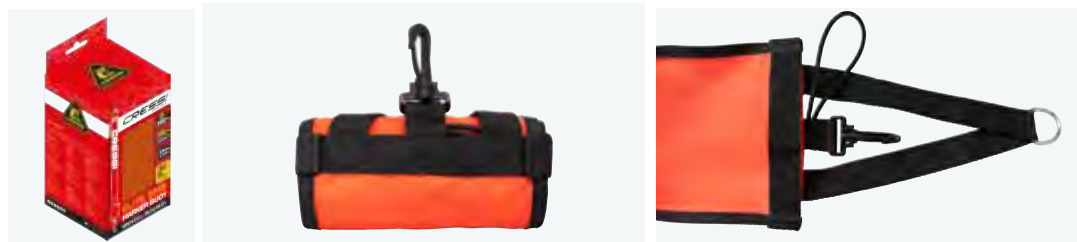

COMPACT ELITE MARKER BUOY

176 CM X 15 CM
51,6 IN X 5,9 IN

The Compact Marker is a versatile and easy-to-use buoy designed for marking surfaces. Thanks to its self-sealing properties, this tall buoy offers remarkable flotation capabilities while maintaining a compact size. If you find yourself far from the shore or boat, this buoy is the perfect tool to capture attention on the surface. Inflation options include breath inflation or the use of a second stage, while an innovative overpressure valve prevents overinflation. In addition, the valve can be used to release air from the Compact Marker when needed. This buoy guarantees efficiency and reliability for any marking requirement.

PRODUCT	CODE		RRP €
ORANGE	TA611818		49,99



MARKER BUOY

0,35 MM
PVC

The Marker Buoy is an indispensable safety tool for your dives. Made of durable tarpaulin, this buoy is easily inflated through the regulator opening on the bottom. The integrated weight at the bottom ensures a stable upright position, while the bright red colour guarantees excellent visibility. After use, the buoy can be easily rolled up and stored in the practical pouch included, which features a rust-proof plastic snap hook for convenient transportation. With a generous 20-meter line and a length of 130 cm, this footbait is essential for signaling your position underwater and adhering to safety standards.

PRODUCT	CODE		RRP €
MARKER BUOY	TA611800		29,99



FINGER SPOOL

The Finger Spool, a versatile accessory, is designed for divers looking for a lightweight yet robust solution. The Cressi polymer finger spool is renowned for its durability and high quality construction. Its wide centre comfortably accommodates divers' fingers, even when wearing gloves. The Flatline design ensures efficient water cutting when deploying surface buoys, maintaining tangle-free operation. Equipped with a double-ended stainless steel clip, this reel ensures secure attachment.

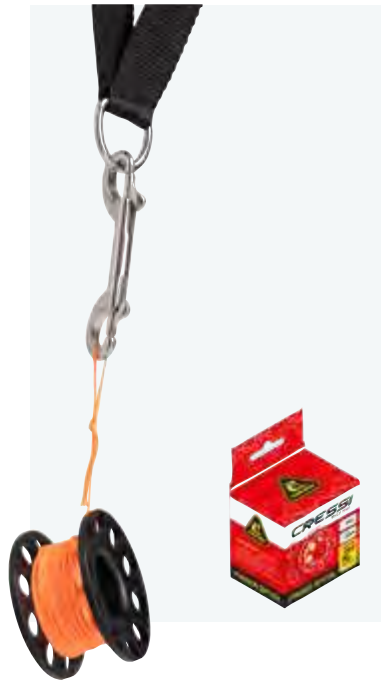

PRODUCT	CODE		RRP €
15m BLACK	TA660150		24.99
30m BLACK	TA660350		29.99

FREEDIVING LANYARD

PRODUCT UPDATE

The Cressi Safety Lanyard is designed to be used as a guide while line diving. Safety lanyards are required to be worn during freediving classes. The Cressi's Safety Lanyard carabiner is stainless steel. The D-ring is made with durable steel. The flexible and strong cable is surrounded by a transparent spine to protect the cable from abrasion. Our comfortable Neoprene strap can be worn on the wrist or ankle. The Neoprene cuff includes a quick release tab to release the cuff.



PRODUCT	CODE		RRP €
FREEDIVING LANYARD	TA640002		59.99



/ BALLOONS & TANKS

HERCULES

LIFTING BALLOON

Professional lifting balloon available in 250, 500 and 1000 kg capacity. High-strength steel rings. HD PVC laminated fabric with high frequency welding. Inflation valve and top valve. Bright color for a great visibility.

BRIGHT YELLOW COLOR FOR MAXIMUM VISIBILITY | STEEL RINGS

PRODUCT	CODE		RRP €
HERCULES LIFTING BALLOON kg 250	KU745002		279.99
HERCULES LIFTING BALLOON kg 500	KU745003		349.99
HERCULES LIFTING BALLOON kg 1000	KU745004		499.99
HERCULES VALVE	KZ745099		49.99



TANKS

STRONG AND RELIABLE TANKS

Cressi tanks are made of high quality and safety standards. They come in 5 different capacities: 5, 10, 12, 15 and 18 litres. On the other hand, the valves are made by Cressi-sub and were the first easy to assemble and disassemble valves to appear on the market. They are strong and reliable and are made from really top quality materials. The inner air passages were carefully studied in the design so as to guarantee top performance even, and above all, with the top performance regulators.

The valve design ensures an excellent grip, facilitating opening and closing of the tank. A brand new, exclusive slot system means you can check whether the faucet is open or closed at a glance (yellow = faucet closed, red = faucet open).

The regulator connection incorporates a threaded insert, which means it can equally be used for both INT bracket or DIN connection. The valves are modular you can easily change from a single connection valve to dual connection valve and vice versa. The Cressi-sub valves passed the strict tests imposed by European standards with flying colours thus receiving the prestigious CE certification.



PRODUCT	CODE		RRP €
CYLINDER 5lt	GB840510		399.99
CYLINDER 10lt	GB841010		459.99
CYLINDER 12lt	GB841210		549.99
CYLINDER 15lt	GB841510		589.99
CYLINDER 18lt	GB841810		629.99
BACKPACK COMPLETE 10/15/18 lt	GB840050		89.99
TANK VALVE CAP BLACK	GZ800050		9.99



Backpack two-piece 10/15/18 LT



Tank Valve Cap

M25X2

Cressi sub uses the M25x2 spacing to thread tanks and control valves in conformity with European Regulations. Using articles (tanks/valves) with a different threading can cause serious accidents.



BELTS & ACCESSORIES

SERPENT NEW 2025

SILICONE MARSEILLAISE WEIGHT BELT

Crafted from 100% High Grade, tear-resistant Silicone, the Serpent belt boasts a 200kg tensile strength, ensuring durability in tough underwater conditions. With higher stretch and flexibility than rubber, it provides a more comfortable fit. Its UV, saltwater, heat, and chemical resistance extends its lifespan, outperforming rubber alternatives. The belt is softer and less abrasive on diving suits, featuring a heavy-duty stainless steel quick-release Marseille buckle with a roller for secure and easy adjustments. With 9 holes spaced 4cm apart, it accommodates all diver sizes. Measuring 4.5cm wide and 4.5mm thick, it's perfect for diving, freediving, and spearfishing.



CODE		RRP €
TA629050		39,99
TA629030		39,99

ULTRA NEW 2025

MARSEILLAISE RUBBER BELT

The Ultra Marseille weight belt is a high-quality, rubber diving accessory designed with a focus on comfort and security. With a thickness of 4 mm, this belt is engineered to withstand the rigors of underwater activities. Its standout feature is the Marseille-style stainless steel buckle, which is known for its robustness and ease of use. This buckle has a pivoting pin that slots into regularly spaced holes along the belt, ensuring a secure fit that can be quickly released in an emergency.

The belt's rubber material is specially formulated for elasticity, allowing it to automatically tighten during a diver's descent as abdominal compression occurs and the thickness of the diving suit decreases. This ensures that the belt remains snugly fitted to the diver's body throughout all phases of the dive, providing a consistent and reliable means of carrying weights. The Ultra Marseille belt's design prioritizes the diver's safety and comfort, making it an essential tool for divers who demand the best in underwater gear.



CODE		RRP €
TA624059		44,99
TA624050		39,99

MARSEILLAISE

MARSEILLAISE PREMIUM RUBBER BELT

Rubber weight belt with stainless steel buckle. Because it is made from a stretch material, the belt automatically tightens up during descent, when it generally loosens due to abdominal pressure and the reduction in the thickness of the wetsuit. Consequently the belt always fits snugly against the diver in every phase of the dive. The quick-release stainless steel buckle provides instinctive and rapid emergency release. The buckle pin passes through, is very strong and is riveted at both ends.



CODE		RRP €
TA626000		49,99

MALTA

QUICK RELEASE ELASTIC BELT

Rubber weight belt with stainless steel buckle. Because it is made from a stretch material, the belt automatically tightens up during descent, when it generally loosens due to abdominal pressure and the reduction in the thickness of the wetsuit. Consequently the belt always fits snugly against the diver in every phase of the dive. The stainless steel buckle has a tilting check pin that fits into the holes situated at regular intervals along the belt. Secure grip and quick emergency release.



CODE		RRP €
TA626010		49,99

GOZO

QUICK RELEASE NYLON BELT

Strong woven nylon weight belt, the buckle provides instinctive and rapid emergency release.



CODE		RRP €
TA625000		24,99

LEAD WEIGHT

1 KG



CODE		RRP €
TA620100		17,99





FOOTWEAR

AQUATREK PRO NEW 2025

LIGHTWEIGHT | 3 MM NEOPRENE

ULTRA COMFORTABLE WATER SHOES

The AquaTrek Pro is a comfortable water shoe engineered for marine environments. Its specialized anti-slip sole ensures stability on various surfaces. The neoprene upper, combined with nylon mesh, facilitates easy slip-on compared to traditional neoprene shoes. Designed for versatility, it transitions seamlessly between water and land activities. Whether walking on

rocky shores or sandy beaches, the AquaTrekPro provides reliable traction and protection. Its lightweight construction and breathable materials enhance comfort during prolonged wear. The practical double puller allows the shoe to be easily slipped on and holds tight even during sports activities in and at the water.



SIZE / SIZE EU	CODE	*CASE PACK	RRP €
XS/36-37	LX4301051	-	29,99
S/38-39	LX4301052	-	29,99
M/40-41	LX4301053	-	29,99
L/42-43	LX4301054	-	29,99
XL/44-45	LX4301055	-	29,99
XXL/46-47	LX4301056	-	29,99

AQUATREK NEW 2025

| LIGHTWEIGHT | 3 MM
NEOPRENE

ULTRA COMFORTABLE WATER SHOES

The AQUATREK is a snug-fitt water shoe that provides you with comfortable protection for your bare feet. Wear them at the beach, walk over rocks

and stones with them, and use them in your fins - the AQUATREK are versatile and provide reliable traction and protection in dry or wet environments.



SIZE / SIZE EU	CODE	*CASE PACK	RRP €
XS/36-37	LX4300051	-	24.99
S/38-39	LX4300052	-	24.99
M/40-41	LX4300053	-	24.99
L/42-43	LX4300054	-	24.99
XL/44-45	LX4300055	-	24.99
XXL/46-47	LX4300056	-	24.99

MINORCA

SHORT BOOTS

Cressi Minorca Shorty Boots are light boots ideal for water sports and traveling. Made of super elastic and ultra-resistant 3 mm neoprene for

superior comfort. They're great for surfing, kayaking, scuba diving, and various water sports.

LIGHTWEIGHT | 3 MM NEOPRENE



BLACK

TECHNICAL FEATURES

- 3 mm Neoprene Warm Water Boots
- Super Elastic and Ultra Durable
- Rubber Heel and Toe Cap for Added Strength and Durability
- Non-skid sole
- Lightweight and suitable for travel



SIZE / SIZE EU	BLACK	*CASE PACK		RRP €
XS/36-37	LX431100	-		39,99
S/38-39	LX431101	-		39,99
M/40-41	LX431102	-		39,99
L/42-43	LX431103	-		39,99
XL/44-45	LX431104	-		39,99
XXL/46-47	LX431105	-		39,99

SONAR

AQUASHOES

DESIGNED FOR FLEXIBILITY | HIGH GRIP

Sonar is a water shoe made of micro-perforated fabric to ensure comfort and adequate water drainage. The elastic laces allow for quick fastening and adapt to all foot shapes, the notched sole

guarantees excellent grip even on wet surfaces and protects from stones and sand. Thanks to its flexibility, it is particularly suitable for those who want to maintain a good tactile feeling underfoot.

TECHNICAL FEATURES

- Quick fastening and adaptability to different foot shapes.
- Excellent grip on wet surfaces, protects from stones and sand
- Flexibility
- Versatile water shoe with drainage and grip
- Ideal for maintaining tactile sensitivity while in water.



BLACK/YELLOW

BLUE/AZURE

SIZE	BLACK/YELLOW	BLUE/AZURE	*CASE PACK	RRP €
35	XVB978135	XVB978235	-	39,99
36	XVB978136	XVB978236	-	39,99
37	XVB978137	XVB978237	-	39,99
38	XVB978138	XVB978238	-	39,99
39	XVB978139	XVB978239	-	39,99
40	XVB978140	XVB978240	-	39,99
41	XVB978141	XVB978241	-	39,99
42	XVB978142	XVB978242	-	39,99
43	XVB978143	XVB978243	-	39,99
44	XVB978144	XVB978244	-	39,99
45	XVB978145	XVB978245	-	39,99
46	XVB978146	XVB978246	-	39,99

MOLOKAI

SHOES FOR SUMMER SPORTS

DESIGNED FOR SUMMER SPORTS | HIGH QUALITY



TECHNICAL FEATURES

- Great shoes for all Summer sports
- They can also be used in water
- Outer Material: Synthetic
- Shoe Width: Medium
- Upper with Laces in special material
- Non-slip sole in high friction coefficient material
- High quality material



SIZE	CODE	CASE PACK	RRP €
35	XVB975335	-	39,99
36	XVB975336	-	39,99
37	XVB975337	-	39,99
38	XVB975338	-	39,99
39	XVB975339	-	39,99
40	XVB975340	-	39,99
41	XVB975341	-	39,99
42	XVB975342	-	39,99
43	XVB975343	-	39,99
44	XVB975344	-	39,99
45	XVB975345	-	39,99
46	XVB975346	-	39,99

BOROCAY

BEACH SHOES

DESIGNED FOR SUMMER SPORTS | FAST DRYING



TECHNICAL FEATURES

- Excellent shoes for all Summer sports
- They can also be used in water
- Non-slip sole made of high friction material
- Fast drying
- Lightweight ideal for travel



SIZE	CODE	*CASE PACK		RRP €
36	XVB976336	-		34,99
37	XVB976337	-		34,99
38	XVB976338	-		34,99
39	XVB976339	-		34,99
40	XVB976340	-		34,99
41	XVB976341	-		34,99
42	XVB976342	-		34,99
43	XVB976343	-		34,99
44	XVB976344	-		34,99
45	XVB976345	-		34,99
46	XVB976346	-		34,99
47	XVB976347	-		34,99

/AQUASHOES

GEKO NEW 2025

AQUASHOES

The Geko shoe is the ideal choice for those seeking an immersive connection with the aquatic environment. Featuring a contoured sole and optimal grip, each step provides an exceptional sense of adherence to the seabed without compromising comfort. With a convenient Velcro fastener, this shoe ensures a secure and customizable fit, adapting seamlessly to all foot types. Upper with precision wrap-around

reinforcements, offering optimal support during sports activities in the water. The contoured sole precisely mimics the foot and toe shape, offering exceptional traction and heightened sensitivity to the seabed. Strategically placed perforations in the sole facilitate rapid water drainage, ensuring quick drying and perspiration.

DESIGNED FOR FLEXIBILITY | HIGH GRIP



BLACK/RED

BLACK/WHITE

AZURE/WHITE

SIZE	BLACK/RED	BLACK/WHITE	AZURE/WHITE	*CASE PACK	RRP €
36	XVC000136	XVC000236	XVC000336	3	29,99
37	XVC000137	XVC000237	XVC000337	3	29,99
38	XVC000138	XVC000238	XVC000338	3	29,99
39	XVC000139	XVC000239	XVC000339	3	29,99
40	XVC000140	XVC000240	XVC000340	3	29,99
41	XVC000141	XVC000241	XVC000341	3	29,99
42	XVC000142	XVC000242	XVC000342	3	29,99
43	XVC000143	XVC000243	XVC000343	3	29,99
44	XVC000144	XVC000244	XVC000344	3	29,99
45	XVC000145	XVC000245	XVC000345	3	29,99
46	XVC000146	XVC000246	XVC000346	3	29,99



ELBA

WRAP SHOES

UPPER SEALED DESIGN | BREATHABLE MESH FABRIC

Insole removable for cleaning non-slip molded outsole material with high coefficient of friction, improves traction and makes the shoe more comfortable.

Wrap shoes for pool, boat, beach etc. allows use in water, thanks to the closing elastic strap.

TECHNICAL FEATURES

Sole material Thermoplastic

Closure Lace-Up

- Shoes for all water sports
- Upper sealed design with special breathable mesh elastic material
- Non-slip sole material with high coefficient of friction
- Ideal for travel

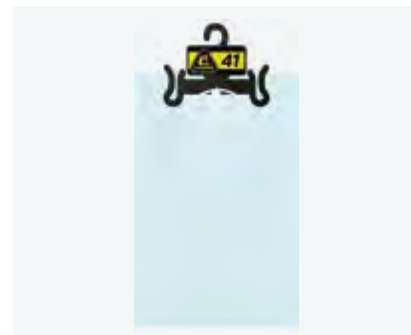

LIGHT BLUE/BLUE

BLACK

BLACK/GREY

SIZE	LIGHT BLUE/BLUE	BLACK	BLACK/GREY	*CASE PACK		RRP €
35	XVB941135	XVB941335	XVB941235	3		19,99
36	XVB941136	XVB941336	XVB941236	3		19,99
37	XVB941137	XVB941337	XVB941237	3		19,99
38	XVB941138	XVB941338	XVB941238	3		19,99
39	XVB941139	XVB941339	XVB941239	3		19,99
40	XVB941140	XVB941340	XVB941240	3		19,99
41	XVB941141	XVB941341	XVB941241	3		19,99
42	XVB941142	XVB941342	XVB941242	3		19,99
43	XVB941143	XVB941343	XVB941243	3		19,99
44	XVB941144	XVB941344	XVB941244	3		19,99
45	XVB941145	XVB941345	XVB941245	3		19,99
46	XVB941146	XVB941346	XVB941246	3		19,99
47	XVB941147	XVB941347	XVB941247	3		19,99
48	XVB941148	XVB941348	XVB941248	3		19,99

/AQUASHOES

COCO

AQUASHOES

Coco is the Cressi water shoe designed for water sports enthusiasts or for those who want to walk comfortably in wet environments, sea and beach. Made with draining fabrics, this shoe is able to drain excess water and guarantee quick drying. The elastic closure and heel clip ensure a perfect

fit on the foot, preventing the shoe from slipping or moving during use. In addition, the ergonomic design and flexible sole ensure a high level of comfort, allowing the shoe to be worn for long hours without tiring the foot.



BLACK/YELLOW



BLUE/AZURE



LIGHT BLUE/BLUE

SIZE	BLACK/YELLOW	BLUE/AZURE	LIGHT BLUE/BLUE	*CASE PACK		RRP €
36	XVB979536	XVB979236	XVB979036	3		17,99
37	XVB979537	XVB979237	XVB979037	3		17,99
38	XVB979538	XVB979238	XVB979038	3		17,99
39	XVB979539	XVB979239	XVB979039	3		17,99
40	XVB979540	XVB979240	XVB979040	3		17,99
41	XVB979541	XVB979241	XVB979041	3		17,99
42	XVB979542	XVB979242	XVB979042	3		17,99
43	XVB979543	XVB979243	XVB979043	3		17,99
44	XVB979544	XVB979244	XVB979044	3		17,99
45	XVB979545	XVB979245	XVB979045	3		17,99
46	XVB979546	XVB979246	XVB979046	3		17,99
*ASSORT.	XVB979000	-	-	24		-

TECHNICAL FEATURES

- Quick water drainage and fast drying
- Perfect fit with elastic closure and heel clip
- Slip-resistant
- Ergonomic design for high comfort
- Suitable for long hours of wear without fatigue
- Ideal for comfortable walking in sea and beach environments

PRODUCT UPDATE

*MEGA PACK ASSORTED BLACK/YELLOW 24XPCS.

- 36 X 1 pz.
- 37 X 3 pcs.
- 38 X 3 pcs.
- 39 X 3 pcs.
- 40 X 2 pcs.
- 41 X 2 pcs.
- 42 X 3 pcs.
- 43 X 3 pcs.
- 44 X 2 pcs.
- 45 X 1 pz.
- 46 X 1 pz.

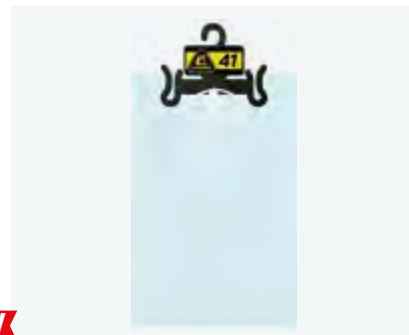

NEW

WATER SHOES

HIGH QUALITY | LIGHT MATERIAL | BREATHABLE MESH MATERIAL

NON-SLIP SOLE

Cressi Water Shoes are made of soft, lightweight elastic material. The sole has a non-skid design, and the upper is perforated along most of its surface,

with a reinforced toe and heel. Comfortable for pool, boat, or reef, and perfect for travel.



TECHNICAL FEATURES

- Enveloping feet made from soft, light material
- The sole has a non-slip pattern, the uppers are perforated over most of the surface
- Very handy for pools, on boats, on rocks
- Lightweight, ideal for travel
- High-quality Cressi



AZURE



CLEAR



BLUE



CLEAR/PINK



CLEAR/LIGHTBLUE

SIZE	AZURE	CLEAR	BLUE	CLEAR/PINK	CLEAR/LIGHTBLUE	*CASE PACK		RRP €
35	VB950035	VB950535	XVB950135	XVB951135	XVB951035	3		17,99
36	VB950036	VB950536	XVB950136	XVB951136	XVB951036	3		17,99
37	VB950037	VB950537	XVB950137	XVB951137	XVB951037	3		17,99
38	VB950038	VB950538	XVB950138	XVB951138	XVB951038	3		17,99
39	VB950039	VB950539	XVB950139	XVB951139	XVB951039	3		17,99
40	VB950040	VB950540	XVB950140	XVB951140	XVB951040	3		17,99
41	VB950041	VB950541	XVB950141	XVB951141	XVB951041	3		17,99
42	VB950042	VB950542	XVB950142	-	-	3		17,99
43	VB950043	VB950543	XVB950143	-	-	3		17,99
44	VB950044	VB950544	XVB950144	-	-	3		17,99
45	VB950045	VB950545	XVB950145	-	-	3		17,99
46	VB950046	VB950546	XVB950146	-	-	3		17,99

/AQUASHOES

KIWI

NEW 2025

UPPER SEALED DESIGN | BREATHABLE MESH FABRIC

AQUASHOES

Kiwi is the Cressi water shoe designed for water sports enthusiasts or for those who want to walk comfortably in wet environments, the sea and beach. Made with draining fabrics, this shoe can drain excess water and guarantee quick drying. The slip-on fastener is very quick to put on, and the

ergonomic design and flexible sole ensure a high level of comfort, allowing the shoe to be worn for many hours without tiring the foot.



BLACK/RED

AZURE/PINK

BLUE/AZURE

SIZE	BLACK/RED	BLUE/AZURE	AZURE/PINK	*CASE PACK		RRP €
36	XVC010236	XVC010136	XVC010336	3		15,99
37	XVC010237	XVC010137	XVC010337	3		15,99
38	XVC010238	XVC010138	XVC010338	3		15,99
39	XVC010239	XVC010139	XVC010339	3		15,99
40	XVC010240	XVC010140	XVC010340	3		15,99
41	XVC010241	XVC010141	XVC010341	3		15,99
42	XVC010242	XVC010142	XVC010342	3		15,99
43	XVC010243	XVC010143	XVC010343	3		15,99
44	XVC010244	XVC010144	XVC010344	3		15,99
45	XVC010245	XVC010145	XVC010345	3		15,99
46	XVC010246	XVC010146	XVC010346	3		15,99

REEF

WATER SHOES

UPPER SEALED DESIGN | BREATHABLE MESH MATERIAL

Reef water shoes have become a classic in Cressi's wide product range, and have earned a top position among our footwear. These shoes are ideal for all water sports thanks to the secure-fit closure.

The upper is a special breathable elasticized mesh material. The new non-skid sole has an improved design that increases the coefficient of friction.

TECHNICAL FEATURES

Sole material Thermoplastic

Closure Slip-On

- Shoes for all water sports
- Upper sealed design with special breathable mesh elastic material
- Non-slip sole material with high coefficient of friction
- Ideal for travel
- High-quality Cressi

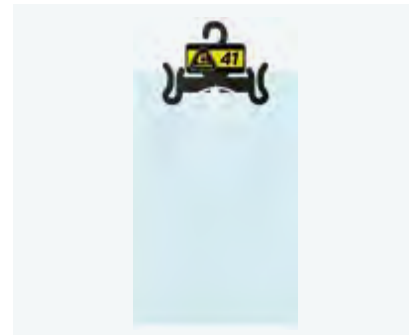

AZURE/BLUE



ROYAL/BLUE



BLACK



RED

SIZE	AZURE/BLUE	ROYAL BLUE	BLACK	RED	*CASE PACK	RRP €
35	VB944935	XVB944535	-	-	3	16.99
36	VB944936	XVB944536	XVB944836	XVB944736	3	16.99
37	VB944937	XVB944537	XVB944837	XVB944737	3	16.99
38	VB944938	XVB944538	XVB944838	XVB944738	3	16.99
39	VB944939	XVB944539	XVB944839	XVB944739	3	16.99
40	VB944940	XVB944540	XVB944840	XVB944740	3	16.99
41	VB944941	XVB944541	XVB944841	XVB944741	3	16.99
42	VB944942	XVB944542	XVB944842	XVB944742	3	16.99
43	VB944943	XVB944543	XVB944843	XVB944743	3	16.99
44	VB944944	XVB944544	XVB944844	XVB944744	3	16.99
45	VB944945	XVB944545	XVB944845	XVB944745	3	16.99
46	VB944946	XVB944546	XVB944846	XVB944746	3	16.99
47	-	-	XVB944847	-	3	16.99
48	-	-	XVB944848	-	3	16.99

/AQUASHOES

CORAL

BEACH SHOES

FORM-FITTING AND COMFORT BREATHABLE MESH MATERIAL

Cressi Coral are form-fitting and lightweight beach shoes for adults, children and youth. Suitable for walking on the street, near water and in water, excellent for boating. They'll protect your feet from scorching sand, rocks, sea-urchins, reefs, and rough

sea beds. Can be worn without socks. The upper, in neoprene and honeycomb fabric, lets the foot breathe. The flexible sole protects the arch of the foot from contact with the ground and is antigrip.

TECHNICAL FEATURES

Sole material	Thermoplastic
Closure	Slip-On
Material	Neoprene + Mesh

- Ideal for walking on dry land and in the water, excellent for boating
- They'll protect your feet from scorching sand, sea-urchin, reefs, and rough seabed's
- Upper in neoprene and honeycomb fabric lets the foot breathe
- The sole protects the foot from contact with the ground and is anti grip
- Form-fitting and comfortable



BLUE/AZURE

BLACK

NAVY

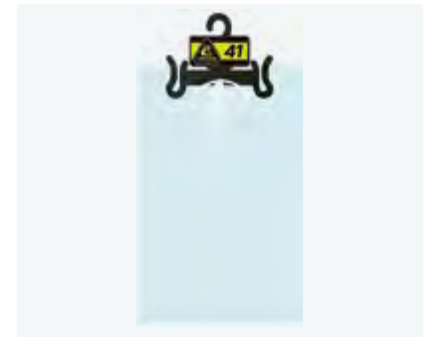

SIZE	BLUE/AZURE	BLACK	NAVY	*CASE PACK	RRP €
35	-	-	XVB949035	3	14,99
36	VB950736	XVB945736	XVB949036	3	14,99
37	VB950737	XVB945737	XVB949037	3	14,99
38	VB950738	XVB945738	XVB949038	3	14,99
39	VB950739	XVB945739	XVB949039	3	14,99
40	VB950740	XVB945740	XVB949040	3	14,99
41	VB950741	XVB945741	XVB949041	3	14,99
42	VB950742	XVB945742	XVB949042	3	14,99
43	VB950743	XVB945743	XVB949043	3	14,99
44	VB950744	XVB945744	XVB949044	3	14,99
45	VB950745	XVB945745	XVB949045	3	14,99
46	VB950746	XVB945746	XVB949046	3	14,99
47	-	-	XVB949047	3	14,99

LUNAR

NEW 2025

UPPER SEALED DESIGN | BREATHABLE MESH FABRIC

JUNIOR AQUASHOES

Explore the aquatic world with Lunar, your ideal companion for summer adventures. Made of breathable perforated technical fabric, this bootie offers coolness and comfort during days at the beach. Featuring an adjustable strap with Velcro closure, it ensures a secure and quick

fit, allowing you to focus on having fun without worry. Lightweight and flexible, Lunar is designed to accompany you on the beach, boat or any water activity.



TURQUOISE/BLUE

BLUE/LIME

PINK/WHITE

SIZE	TURQUOISE/BLUE	BLUE/LIME	PINK/WHITE	*CASE PACK	RRP €
23	XVC011123	XVC011223	XVC011323	3	19,99
24	XVC011124	XVC011224	XVC011324	3	19,99
25	XVC011125	XVC011225	XVC011325	3	19,99
26	XVC011126	XVC011226	XVC011326	3	19,99
27	XVC011127	XVC011227	XVC011327	3	19,99
28	XVC011128	XVC011228	XVC011328	3	19,99
29	XVC011129	XVC011229	XVC011329	3	19,99
30	XVC011130	XVC011230	XVC011330	3	19,99
31	XVC011131	XVC011231	XVC011331	3	19,99
32	XVC011132	XVC011232	XVC011332	3	19,99
33	XVC011133	XVC011233	XVC011333	3	19,99
34	XVC011134	XVC011234	XVC011334	3	19,99
35	XVC011135	XVC011235	XVC011335	3	19,99



UPPER
SEALED DESIGN

BREATHABLE
MESH FABRIC

COCO JR

PRODUCT UPDATE

KID SIZE

Coco is the Cressi water shoe designed for water sports enthusiasts or for those who want to walk comfortably in wet environments, sea and beach. Made with draining fabrics, this shoe is able to drain excess water and guarantee quick drying. The elastic closure and heel clip ensure a perfect

fit on the foot, preventing the shoe from slipping or moving during use. In addition, the ergonomic design and flexible sole ensure a high level of comfort, allowing the shoe to be worn for long hours without tiring the foot.



TECHNICAL FEATURES

- Quick water drainage and fast drying
- Perfect fit with elastic closure and heel clip
- Slip-resistant
- Ergonomic design for high comfort
- Suitable for long hours of wear without fatigue
- Ideal for comfortable walking in sea and beach environments

PRODUCT UPDATE

***MEGA PACK ASSORTED BLUE/AZURE 14XPCS.**

- 28 X 1 pz.
- 29 X 1 pcs.
- 30 X 2 pcs.
- 31 X 2 pcs.
- 32 X 2 pcs.
- 33 X 2 pcs.
- 34 X 2 pcs.
- 35 X 2 pcs.



SIZE	BLUE/AZURE	*CASE PACK		RRP €
28	XVB979228	3		15,99
29	XVB979229	3		15,99
30	XVB979230	3		15,99
31	XVB979231	3		15,99
32	XVB979232	3		15,99
33	XVB979233	3		15,99
34	XVB979234	3		15,99
35	XVB979235	3		15,99
*ASSORT.	XVB979203	14		-





HIGH QUALITY | THERMOPLASTIC MATERIAL

WATER SHOES JR

KID SIZE

Cressi Water Shoes are made of soft and elastic material. The sole has a non-skid design, and the upper is perforated along most of its surface, with a reinforced toe and heel. Comfortable for pool, boat, or reef, and perfect for travel.

TECHNICAL FEATURES

- Made of soft thermoplastic material
- The sole has a non-slip pattern, the uppers are perforated over most of the surface
- Very handy for pools, on boats, on rocks
- Lightweight, ideal for travel
- High-quality Cressi



CLEAR



PINK



AZURE

SIZE	CLEAR	PINK	AZURE	*CASE PACK		RRP €
23/24	VB950523	VB950423	VB950023	3		14,99
25/26	VB950525	VB950425	VB950025	3		14,99
27/28	VB950527	VB950427	VB950027	3		14,99
29/30	VB950529	VB950429	VB950029	3		14,99
31/32	VB950531	VB950431	VB950031	3		14,99
33/34	VB950533	VB950433	VB950033	3		14,99





CRESSI
KIDS



CRESSI
JUNIOR

CORAL JR

KID SIZE

Cressi Coral JR are form-fitting and lightweight beach shoes. Suitable for walking on the street, near water and in water, excellent for boating. They'll protect your feet from scorching sand, rocks, sea-urchins, reefs, and rough sea beds.

Can be worn without socks. The upper, in neoprene and honeycomb fabric, lets the foot breathe. The flexible sole protects the arch of the foot from contact with the ground and is antigrip.

STRAP ADJUSTMENT | FORM-FITTING AND COMFORT | WITH MESH

TECHNICAL FEATURES

Sole material Thermoplastic

Closure Slip-On

Upper Material Neoprene

- Ideal for the Beach or General outdoor watersports use
- High Grip sole (Not suitable for tiled surfaces)
- With velcro tab for extra adjustment



WHITE/BLUE



BLUE/LIGHTBLUE



PINK/WHITE



SIZE	WHITE/BLUE	BLUE/LIGHT BLUE	PINK/WHITE	*CASE PACK	RRP €
23	VB945023	XVB945223	XVB945323	3	14,99
24	VB945024	XVB945224	XVB945324	3	14,99
25	VB945025	XVB945225	XVB945325	3	14,99
26	VB945026	XVB945226	XVB945326	3	14,99
27	VB945027	XVB945227	XVB945327	3	14,99
28	VB945028	XVB945228	XVB945328	3	14,99
29	VB945029	XVB945229	XVB945329	3	14,99
30	VB945030	XVB945230	XVB945330	3	14,99
31	VB945031	XVB945231	XVB945331	3	14,99
32	VB945032	XVB945232	XVB945332	3	14,99
33	VB945033	XVB945233	XVB945333	3	14,99
34	VB945034	XVB945234	XVB945334	3	14,99
35	VB945035	XVB945235	XVB945335	3	14,99

PULPY

NEW COLOR 2025

KID SIZE

Cressi Pulpy water shoes are made of a single soft and lightweight material. They'll protect your feet from scorching sand, rocks, sea urchins, reefs, and rough seabeds. You can wear them on bare feet, and they work just as well near the water as they

do strolling down the street. Pulpy shoes have a fun look and come in bright colors. They'll be your inseparable leisure companions, step after step.

TECHNICAL FEATURES

- Ideal for walking on the beach, in the sea, on the reef, or over rough seabeds
- Available in two colours
- Soft and lightweight
- Can be used in the water and ashore



FUCHSIA/WHITE



BLUE/KIWI



RED/YELLOW

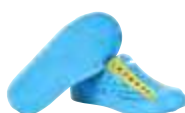

SKY/YELLOW



ORANGE/WHITE



SIZE	FUCHSIA/WHITE	BLUE/KIWI	RED/YELLOW	SKY/YELLOW	ORANGE/WHITE	*CASE PACK	RRP €
22	XVB9479122	XVB9482122	XVB9481122	XVB9483122	XVB948322	3	9,99
23	XVB9479123	XVB9482123	XVB9481123	XVB9483123	XVB948323	3	9,99
24	XVB9479124	XVB9482124	XVB9481124	XVB9483124	XVB948324	3	9,99
25	XVB9479125	XVB9482125	XVB9481125	XVB9483125	XVB948325	3	9,99
26	XVB9479126	XVB9482126	XVB9481126	XVB9483126	XVB948326	3	9,99
27	XVB9479127	XVB9482127	XVB9481127	XVB9483127	XVB948327	3	9,99
28	XVB9479128	XVB9482128	XVB9481128	XVB9483128	XVB948328	3	9,99
29	XVB9479129	XVB9482129	XVB9481129	XVB9483129	XVB948329	3	9,99
30	XVB9479130	XVB9482130	XVB9481130	XVB9483130	XVB948330	3	9,99
31	XVB9479131	-	XVB9481131	XVB9483131	XVB948331	3	9,99
32	XVB9479132	-	XVB9481132	XVB9483132	XVB948332	3	9,99
33	XVB9479133	-	XVB9481133	XVB9483133	XVB948333	3	9,99
34	XVB9479134	-	XVB9481134	XVB9483134	-	3	9,99
35	XVB9479135	-	XVB9481135	XVB9483135	-	-	9,99



Photo by: IG Calabria



SANDALS & FLIP-FLIPS

LUCA

NEW 2025

CLOSED ADULT SANDALS

The "Luca" hiking sandal is the perfect companion for outdoor adventures, crafted to provide comfort, safety, and versatility. Featuring a durable rubber toe cap that wraps around and shields the toes, the sandal ensures a secure stride even on rugged terrains. Convenience takes center stage in the design, with an adjustable heel strap secured by a Velcro closure and an elastic lace around the collar, allowing for a customized fit that is quick and easy to adjust to individual feet. Especially well-suited for excursions in aquatic environments, the "Luca"

sandal allows the foot to breathe, thanks to its breathable structure. The combination of high-quality materials ensures durability and resilience, while the robust sole provides excellent traction on varying terrains. With its contemporary style and user-friendly adjustments, the "Luca" sandal is the perfect choice for those seeking a reliable companion to explore nature with both style and confidence.

SOFT MATERIAL | NON-SLIP SOLE | REINFORCED CLOSURE



BLACK/YELLOW

BLACK/BLUE

SIZE	BLACK/YELLOW	BLACK/BLUE	*CASE PACK	RRP €
36	XVC100136	XVC100236	-	39.99
37	XVC100137	XVC100237	-	39.99
38	XVC100138	XVC100238	-	39.99
39	XVC100139	XVC100239	-	39.99
40	XVC100140	XVC100240	-	39.99
41	XVC100141	XVC100241	-	39.99
42	XVC100142	XVC100242	-	39.99
43	XVC100143	XVC100243	-	39.99
44	XVC100144	XVC100244	-	39.99
45	XVC100145	XVC100245	-	39.99
46	XVC100146	XVC100246	-	39.99



SAM

NEW 2025

SUMMER SANDALS

Discover summer in ultimate comfort with "Sam" by Cressi, the incredibly lightweight sandals designed to provide a sense of freedom with every step. Featuring adjustable Velcro straps for a perfect fit and a sole crafted for maximum comfort, these sandals are perfect for aquatic

environments. Embrace the lightness without compromising style, experiencing the feeling of walking on clouds during your summer adventures with the trusted quality of Cressi.

SOFT MATERIAL | NON-SLIP SOLE | REINFORCED CLOSURE



BLACK

BLACK/BLUE

SIZE	BLACK	BLACK/BLUE	*CASE PACK	RRP €
36	XVB968136	XVB968236	-	39.99
37	XVB968137	XVB968237	-	39.99
38	XVB968138	XVB968238	-	39.99
39	XVB968139	XVB968239	-	39.99
40	XVB968140	XVB968240	-	39.99
41	XVB968141	XVB968241	-	39.99
42	XVB968142	XVB968242	-	39.99
43	XVB968143	XVB968243	-	39.99
44	XVB968144	XVB968244	-	39.99
45	XVB968145	XVB968245	-	39.99
46	XVB968146	XVB968246	-	39.99

PETE NEW 2025

SUMMER SANDALS

The Pete sandal is designed to offer comfort and convenience during your summer days at the beach. With sturdy adjustable straps equipped with Velcro fasteners, it ensures a secure and adaptable fit. The ultra-lightweight cleated sole provides reliable traction, making it the ideal companion

for long walks in the sand. Pete is designed for maximum functionality, allowing you to tackle summer activities with ease and without sacrificing comfort. Enjoy Pete's lightness and comfort on your walks along the beach and enjoy your summer outdoors to the full.

- SOFT MATERIAL
- NON-SLIP SOLE
- REINFORCED CLOSURE



SAND/WHITE



BLACK/BLUE



BLACK/YELLOW



BLACK/WHITE

SIZE	SAND/WHITE	BLACK/BLUE	BLACK/YELLOW	BLACK/WHITE	CASE PACK	RRP €
36	XVB967336	XVB967136	XVB967036	XVB967236	2	29.99
37	XVB967337	XVB967137	XVB967037	XVB967237	2	29.99
38	XVB967338	XVB967138	XVB967038	XVB967238	2	29.99
39	XVB967339	XVB967139	XVB967039	XVB967239	2	29.99
40	XVB967340	XVB967140	XVB967040	XVB967240	2	29.99
41	XVB967341	XVB967141	XVB967041	XVB967241	2	29.99
42	-	XVB967142	XVB967042	XVB967242	2	29.99
43	-	XVB967143	XVB967043	XVB967243	2	29.99
44	-	XVB967144	XVB967044	XVB967244	2	29.99
45	-	XVB967145	XVB967045	XVB967245	2	29.99
46	-	XVB967146	XVB967046	XVB967246	2	29.99

VALENCIA

ESPADRILLAS

Cressi Valencia are comfortable Unisex Multipurpose Espadrilles, perfect for summer. Durable and painstakingly trimmed fabric with a sole in a soft and comfortable rubber material.

Easy to put on, they also help keep out sand and can be worn in the water. The use of high-quality materials makes them stand out.

UNISEX | RUBBER SOLE | HIGH-QUALITY MATERIALS

TECHNICAL FEATURES

- Unisex Multipurpose Espadrilles
- Rubber sole
- Can also be worn in the water
- High Quality Materials
- Easy to wear



BLUE

WHITE

RED

BLACK

SIZE	BLUE	WHITE	RED	BLACK	*CASE PACK		RRP €
35	XVB980235	XVB980135	XVB980435	XVB980535	3		24,99
36	XVB980236	XVB980136	XVB980436	XVB980536	3		24,99
37	XVB980237	XVB980137	XVB980437	XVB980537	3		24,99
38	XVB980238	XVB980138	XVB980438	XVB980538	3		24,99
39	XVB980239	XVB980139	XVB980439	XVB980539	3		24,99
40	XVB980240	XVB980140	XVB980440	XVB980540	3		24,99
41	XVB980241	XVB980141	XVB980441	XVB980541	3		24,99
42	XVB980242	XVB980142	XVB980442	XVB980542	3		24,99
43	XVB980243	XVB980143	XVB980443	XVB980543	3		24,99
44	XVB980244	XVB980144	XVB980444	XVB980544	3		24,99
45	XVB980245	XVB980145	XVB980445	XVB980545	3		24,99
46	XVB980246	XVB980146	XVB980446	XVB980546	3		24,99



SOFT MATERIAL | NON-SLIP SOLE | REINFORCED CLOSURE

JOY

NEW 2025

JUNIOR SUMMER SANDALS

The "Joy" kids' hiking sandal is the perfect companion for outdoor adventures for the little ones, designed to provide comfort, safety, and versatility. Equipped with a durable rubber toe cap that wraps around and protects the toes, the sandal ensures a secure walk even on rugged terrains. Practicality is at the heart of the design, featuring a convenient elastic closure around the foot's collar for a personalized and easy fit. Particularly suitable for excursions in aquatic

environments, the "Joy" sandal allows little feet to breathe, thanks to its breathable structure. The combination of high-quality materials ensures durability and resistance, while the sturdy sole provides excellent traction on various terrains. With its contemporary style and user-friendly adjustments, the "Joy" sandal is the perfect choice for parents seeking a reliable companion to allow their children to explore nature with style and safety.



AZURE/BLUE



PINK/BLACK

SIZE	AZURE/BLUE	PINK/BLACK	CASE PACK	RRP €
23	XVC101223	XVC101123	-	39,99
24	XVC101224	XVC101124	-	39,99
25	XVC101225	XVC101125	-	39,99
26	XVC101226	XVC101126	-	39,99
27	XVC101227	XVC101127	-	39,99
28	XVC101228	XVC101128	-	39,99
29	XVC101229	XVC101129	-	39,99
30	XVC101230	XVC101130	-	39,99
31	XVC101231	XVC101131	-	39,99
32	XVC101232	XVC101132	-	39,99
33	XVC101233	XVC101133	-	39,99
34	XVC101234	XVC101134	-	39,99
35	XVC101235	XVC101135	-	39,99

LIPARI

IDEAL FOR THE SWIMMING POOL

Cressi Lipari are perfect to be used on the beach or in the pool. With anatomically molded sole and made of special foam material for long-term hypoallergenic and ergonomic.

SOFT MATERIAL | FOAM SOLE | ANATOMIC SOLE

TECHNICAL FEATURES

Strap material	Fabric
Closure	Slip-On
Sole Material	Foam

- Pool sandals made with all the technical innovations to make it a top class product
- The anatomic sole is moulded from special anti-bacterial and light co-polymer foam
- They come with a non-slip patterned sole and raised sides to hold the foot perfectly
- Comfortable, Ergonomic Design
- Suitable for shower, swimming
- Soft to wear and wash



BLACK



BLUE

SIZE	BLACK	BLUE	*CASE PACK	RRP €
35	VB951635	XVB9516135	3	10,99
36	VB951636	XVB9516136	3	10,99
37	VB951637	XVB9516137	3	10,99
38	VB951638	XVB9516138	3	10,99
39	VB951639	XVB9516139	3	10,99
40	VB951640	XVB9516140	3	10,99
41	VB951641	XVB9516141	3	10,99
42	VB951642	XVB9516142	3	10,99
43	VB951643	XVB9516143	3	10,99
44	VB951644	XVB9516144	3	10,99
45	VB951645	XVB9516145	3	10,99
46	VB951646	XVB9516146	3	10,99

PANAREA

IDEAL FOR THE SWIMMING POOL

Cressi Shoes Panarea are comfortable slip-on sandals for the beach or the pool with a preformed anatomic sole made in a special anallergic rubbery

material that is long-lasting. Convenient adjustable strap closure for a perfect grip on your foot. Cressi logo imprinted on the upper side.

FABRIC STRAP | FOAM SOLE | ANATOMIC SOLE

TECHNICAL FEATURES

- Perfect sandals for the beach, pool, or gym
- Anatomical preformed thick sole
- Adjustable velcro strap
- Quick drying
- Non-slip water-resistant sole



BLACK



BLUE

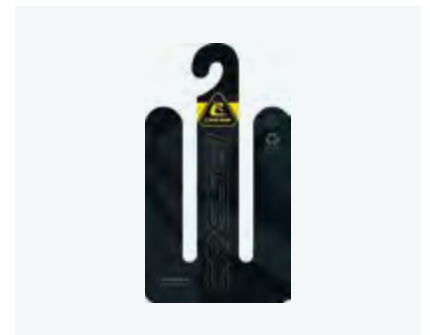

SIZE	BLACK	BLUE	*CASE PACK	RRP €
35	XVB9519035	XVB9519135	3	14,99
36	XVB9519036	XVB9519136	3	14,99
37	XVB9519037	XVB9519137	3	14,99
38	XVB9519038	XVB9519138	3	14,99
39	XVB9519039	XVB9519139	3	14,99
40	XVB9519040	XVB9519140	3	14,99
41	XVB9519041	XVB9519141	3	14,99
42	XVB9519042	XVB9519142	3	14,99
43	XVB9519043	XVB9519143	3	14,99
44	XVB9519044	XVB9519144	3	14,99
45	XVB9519045	XVB9519145	3	14,99
46	XVB9519046	XVB9519146	3	14,99
47	XVB9519047	XVB9519147	3	14,99



CRESSI
KIDS



CRESSI
JUNIOR

FABRIC
STRAP

FOAM
SOLE

ANATOMIC
SOLE

/ SLIDES

LIPARI JR

IDEAL FOR THE SWIMMING POOL

Cressi Lipari are perfect to be used on the beach or in the pool. With anatomically molded sole and made of special foam material for long-term hypoallergenic and ergonomic.



TECHNICAL FEATURES

Strap material Fabric

Closure Slip-On

Sole Material Foam

- Pool sandals made with all the technical innovations to make it a top class product
- The anatomic sole is moulded from special anti-bacterial and light co-polymer foam
- They come with a non-slip patterned sole and raised sides to hold the foot perfectly
- Comfortable, Ergonomic Design
- Suitable for shower, swimming
- Soft to wear and wash



SIZE	CODE	*CASE PACK		RRP €
27	VB951427	3		9,99
28	VB951428	3		9,99
29	VB951429	3		9,99
30	VB951430	3		9,99
31	VB951431	3		9,99
32	VB951432	3		9,99
33	VB951433	3		9,99
34	VB951434	3		9,99

BUBBLE FLIP-FLOP

NEW 2025

RUBBER MATERIAL

Cressi Gummy are comfortable and affordable flip flops for the pool or the beach, in soft and comfortable long-lasting rubber material.

TECHNICAL FEATURES

- Flip flops in soft and comfortable long-lasting rubbery material
- Cressi logo embossed on thong upper
- Ideal for the shower
- Quick drying
- Italian Design



BLACK



BLUE NAVY



SIZE	BLACK	BLUE NAVY	*CASE PACK	RRP €
37/38	VB960537	VB960237	3	19,99
39/40	VB960539	VB960239	3	19,99
41/42	VB960541	VB960241	3	19,99
43/44	VB960543	VB960243	3	19,99
45/46	VB960545	VB960245	3	19,99
47/48	VB960547	VB960247	3	19,99

LEAF

FLIP-FLOP

LIGHTWEIGHT | NATURAL RUBBER | QUICK DRYING

The Cressi Leaf flip-flops, made of natural rubber, are a comfortable and versatile choice for the summer. Thanks to their lightness and the comfort they offer, these flip-flops are perfect for everyday use. The natural rubber used in their production is also water-resistant, ensuring the flip-flops

dry quickly and making them easy to clean. Their simple and functional design makes them easy to put on and take off, while the range of colours available adapts to each customer's needs. Cressi flip-flops made of natural rubber offer the perfect combination of style and functionality.

TECHNICAL FEATURES

- Comfortable and versatile
- Made of natural rubber for durability
- Lightweight and comfortable for everyday use
- Water-resistant material for quick drying



BLACK/YELLOW

BLACK/RED

AZURE

BLUE

SIZE	BLACK/YELLOW	BLACK/RED	AZURE	BLUE	*CASE PACK	RRP €
35/36	XVB966035	XVB966135	XVB966235	XVB966335	3	14,99
37/38	XVB966037	XVB966137	XVB966237	XVB966337	3	14,99
39/40	XVB966039	XVB966139	XVB966239	XVB966339	3	14,99
41/42	XVB966041	XVB966141	XVB966241	XVB966341	3	14,99
43/44	XVB966043	XVB966143	XVB966243	XVB966343	3	14,99
45/46	XVB966045	XVB966145	XVB966245	XVB966345	3	14,99

PORTOFINO

FLIP-FLOP

LIGHTWEIGHT | SOFT FABRIC | QUICK DRYING

As the name suggests, Portofino is a popular, well known and fashionable village of the Ligurian Coast (Riviera). It rises in a sheltered bay in the Gulf of Tigullio, where the untouched nature is combined

with this simple fishing village and its alleys with colorful narrow houses, one built over the other. These flip-flops are the expression of a similar quite elegance.



BLUE



BLACK/LIGHTBLUE

TECHNICAL FEATURES

- The strap material is very comfortable even between the toes: it doesn't rub or scrape, as it is made of soft fabric
- Multilayered, ergonomic footbed, with a deepened stamped antislip inscription
- Very comfortable flip-flops for adults. Really functional shoes for wet, uneven ground and sand
- Very light, therefore ideal for sports and travel luggage
- Quick-drying and washable material
- Classic and casual flip-flops, ideal for beach and pool
- Very robust and soft antislip sole

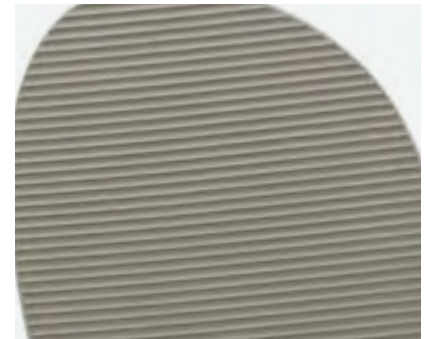

SIZE	BLUE	BLACK/LIGHT BLUE	*CASE PACK	RRP €
38	VB957538	XVB9575138	3	17,99
39	VB957539	XVB9575139	3	17,99
40	VB957540	XVB9575140	3	17,99
41	VB957541	XVB9575141	3	17,99
42	VB957542	XVB9575142	3	17,99
43	VB957543	XVB9575143	3	17,99
44	VB957544	XVB9575144	3	17,99
45	VB957545	XVB9575145	3	17,99
46	VB957546	XVB9575146	3	17,99

BAHAMAS

FLIP-FLOP

ANALLERGIC MATERIAL | QUICK DRYING

Cressi Bahamas are comfy and affordable flip flops for the pool or the beach, in soft and comfortable

anallergic and long-lasting material. The Cressi logo is imprinted on the strap.

TECHNICAL FEATURES

- Ideal for the pool and the beach
- In soft and comfortable anallergic material
- Non-slip water-resistant sole
- Dries quickly
- Italian Design

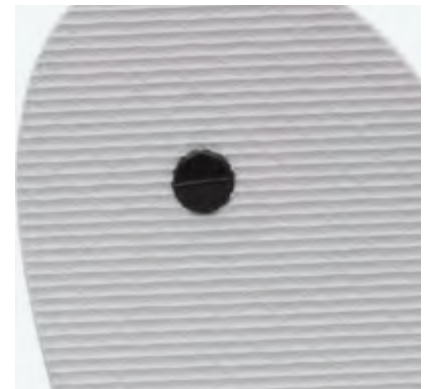

AZURE



BLACK



GREY

SIZE	AZURE	BLACK	GREY	*CASE PACK	RRP €
35/36	VB954535	XVB9545135	XVB9545335	3	12.99
37/38	VB954537	XVB9545137	XVB9545337	3	12.99
39/40	VB954539	XVB9545139	XVB9545339	3	12.99
41/42	VB954541	XVB9545141	XVB9545341	3	12.99
43/44	VB954543	XVB9545143	XVB9545343	3	12.99
45/46	VB954545	XVB9545145	XVB9545345	3	12.99

MARBELLA

LADY FLIP-FLOP

ANALLERGIC MATERIAL | SOFT MATERIAL

Cressi Marbella flip flops are ideal for those who want extraordinary comfort during their days at the beach or pool. These flip flops are made from a hypoallergenic thermoplastic material that offers incredible softness and durability. Every step is a pleasure thanks to the ergonomic design, while the hypoallergenic material guarantees an unbothering

fit. Whether you are walking on the sand or relaxing by the pool, these Marbella slippers guarantee maximum comfort. They are the perfect choice for those looking for style, durability and a feeling of well-being in their feet at all times of the summer.

TECHNICAL FEATURES

- Very comfortable
- Soft material
- Non-allergenic thermoplastic material



GOLD



BROWN GOLD



LIGHT BLUE

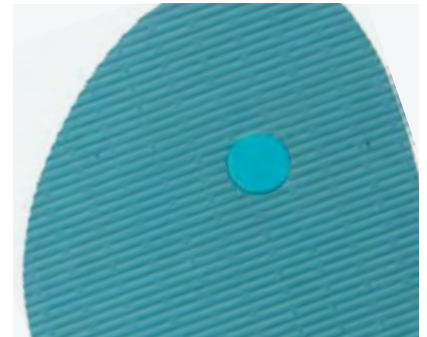

SIZE	GOLD	BROWN GOLD	LIGHT BLUE	*CASE PACK	RRP €
35/36	XVB958635	XVB958735	XVB959135	3	11,99
37/38	XVB958637	XVB958737	XVB959137	3	11,99
39/40	XVB958639	XVB958739	XVB959139	3	11,99

BEACH FLIP-FLOP

ANALLERGIC MATERIAL | THERMOPLASTIC MATERIAL

The Cressi Beach flip-flops, perfect for swimming pools and the sea, are made of soft, hypoallergenic thermoplastic material. These flip-flops offer lasting comfort thanks to their durable design. The

Cressi logo is printed on the sole, a touch of style and quality. Perfect for relaxing in the summer sun, these Beach flip flops combine fashion and functionality

TECHNICAL FEATURES

Material Non-allergenic thermoplastic material

- Very comfortable
- Thermoplastic soft material

NEW

***MEGA PACK ASSORTED BLACK 24XPCS.**

- 35/36 X 2 pz.
- 37/38 X 3 pcs.
- 39/40 X 4 pcs.
- 41/42 X 6 pcs.
- 43/44 X 6 pcs.
- 45/46 X 3 pcs.

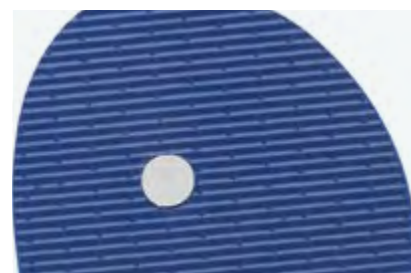

BLACK



NAVY/BLUE



GREEN/YELLOW



DARK GREEN/LIME



BLUE/WHITE

SIZE	BLACK	NAVY/BLUE	GREEN/YELLOW	D.GREEN/LIME	BLUE/WHITE	*CASE PACK		RRP €
35/36	VB953935	XVB9539535	XVB9539235	XVB9539335	XVB9539135	3		9.99
37/38	VB953937	XVB9539537	XVB9539237	XVB9539337	XVB9539137	3		9.99
39/40	VB953939	XVB9539539	XVB9539239	XVB9539339	XVB9539139	3		9.99
41/42	VB953941	XVB9539541	XVB9539241	XVB9539341	XVB9539141	3		9.99
43/44	VB953943	XVB9539543	XVB9539243	XVB9539343	XVB9539143	3		9.99
45/46	VB953945	XVB9539545	XVB9539245	XVB9539345	XVB9539145	3		9.99
*M.P.	VB953900	-	-	-	-	24		-

SUNGLASSES



CRESSI LENSES TECHNOLOGY

HTC TREATMENT

The HTC treatment that Cressi has perfected protects the lenses from dirt and is water-repellent. It combines the benefits of multilayer anti-reflective treatments with the hardening treatment. This is the best treatment that Cressi Sunglasses has ever produced on sunglass lenses. Thanks to the protective HTC (Hydrophobic Tech Coating) treatment, droplets of water slide from the surfaces, leaving them free of streaks and dirt. This protection makes the lenses more durable and long-lasting, for sharp and defined vision. The HTC layer helps the lens stay resistant to dirt, and makes it super smooth and easy to clean.

STANDARD LENSES



HYDROPHOBIC LENSES



POLARIZED LENSES

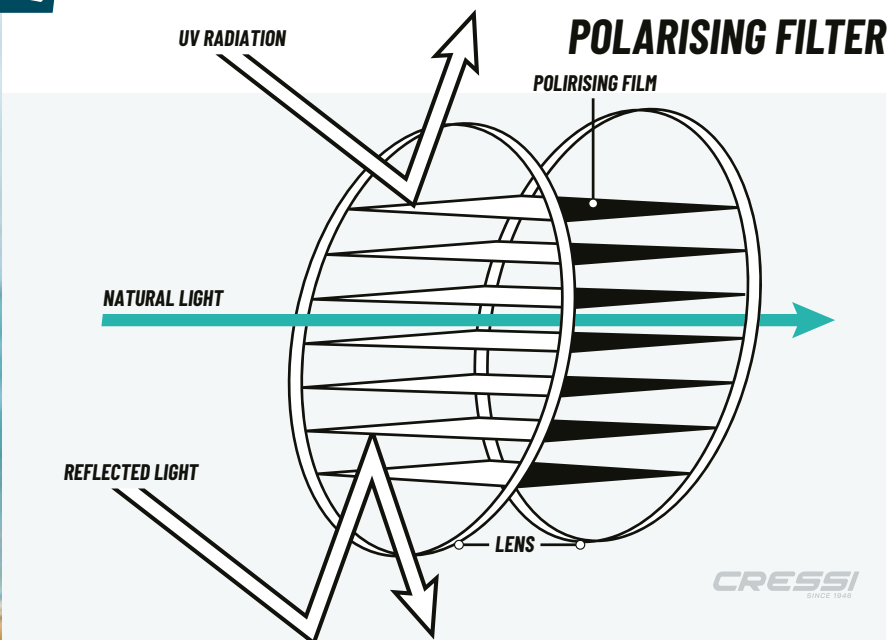

The polarising filter adopted by CRESSI to make its lenses antireflection and anti-glare ensures ultra clear vision at all times. CRESSI's polarised glasses block the blinding light reflected by a horizontal surface, such as water or an asphalted road, and at the same time allow the vertical light to reach the eye. Vertical light is important for the human eye and makes for improved vision.

CRESSI sunglasses are characterised by superior optical quality, they block reflections and ensure 100% protection against UV rays. The lenses offer crystal clear vision, rich in detail, and enhance contrast while protecting the eyes from harmful rays. Taken together, all these features make for enhanced comfort while minimising eye fatigue.

BILL

SUNGLASSES WITH FLOATING LACE

The new Bill sunglasses are the perfect product for lovers of water activities. Their lace is made of a special foam that gives the frame the ability to float, ensuring safety and easy recovery in the event of a fall into the water. Polarized lenses with hydrophobic anti-drip treatment ensure clear vision even in the presence of water, splashes and wet conditions, offering

excellent protection from the harmful effects of the sun's rays. The ergonomic design of the Bill sunglasses is designed to ensure a firm and secure grip, thanks to the presence of an anti-slip grip on the frame, making them ideal for all water sports and recreational activities.



BLACK



BLACK/MIRRORED BLUE



BLACK/MIRRORED ORANGE



BLUE/MIRRORED BLUE



SAND/BLACK

COLOR	CODE	RRP €
BLUE/MIRRORED LENS BLUE	XDB101220	49,99
SAND/SMOKED LENS BLACK	XDB101750	49,99
BLACK/SMOKED LENS BLACK	XDB101550	49,99
BLACK/MIRRORED LENS ORANGE	XDB101585	49,99
BLACK/MIRRORED LENS BLUE	XDB101520	49,99

TECHNICAL FEATURES

- Lenses
 - Protective
 - Polarized
 - Antireflection

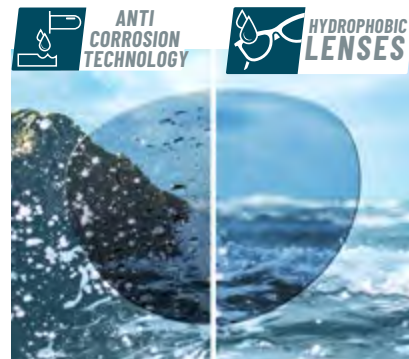

HTC TREATMENT

The HTC treatment that Cressi has perfected protects the lenses from dirt and is water-repellent. It combines the benefits of multilayer anti-reflective treatments with the hardening treatment. This is the best treatment that Cressi Sunglasses has ever produced on sunglass lenses. Thanks to the protective HTC (Hydrophobic Tech Coating) treatment, droplets of water slide from the surfaces, leaving them free of streaks and dirt. This protection makes the lenses more durable and long-lasting, for sharp and defined vision. The HTC layer helps the lens stay resistant to dirt, and makes it super smooth and easy to clean.

SEA WATER⁺ ANTI - CORROSION TECHNOLOGY **NEW**

Revolutionary acid-, base- and corrosion-resistant protection, ideal against seawater. A unique coating process is adopted to ensure optimal performance. Tested for 48 hours in seawater. In addition to its saltwater resistance, it also offers oil protection; a reliable solution to ensure durability and performance in any coastal environment, without compromise.





POLARIZED LENSES



HYDROPHOBIC LENSES

100% UV PROTECTION

HIGH-QUALITY SHATTERPROOF

POLARIZED FILTER 3 CATEGORY

SOFT RUBBER COATING

SOFT RUBBER COATING



FLOATING PRODUCT

NINJA FLOATING

FLOATING, POLARIZED AND HYDROFOMIC SUNGLASSES

Ninja sunglasses are just perfect for those practising sports in general, and especially for those who enjoy fishing, jet skiing, windsurfing and sailing. This special floating version confirms that their ideal use is in water sports. The solar filters in the lenses offer 100% protection from UV rays, block luminous reflections and glare, ensuring crystal clear vision and good contrast.

Thanks to the WRH treatment that makes them water-repellent and hydrophobic, the lenses remain clean at all times, yet another feature that makes these glasses indispensable when boating or sailing. The antireflection treatment also comes in handy when driving, in that it drastically reduces reflection from the road surface and improves vision.

TECHNICAL FEATURES

- Lenses**
- Protective
 - Polarized
 - Antireflection



BLACK



BLACK MIRRORRED/BLUE



BLACK MIRRORRED/ORANGE



BLACK MIRRORRED/GREEN



BLACK MIRRORRED



SHINY BLACK

COLOR	CODE	RRP €
BLACK	DB100002	39,99
MIRRORRED LENS BLUE	XDB100006	39,99
MIRRORRED LENS ORANGE	XDB100004	39,99
MIRRORRED LENS GREEN	XDB100009	39,99
MIRRORRED LENS	DB100003	39,99
SHINY BLACK	XDB100000	39,99





POLARIZED LENSES



HYDROPHOBIC LENSES

100% UV PROTECTION

HIGH-QUALITY SHATTERPROOF

POLARIZED FILTER 3 CATEGORY

SOFT RUBBER COATING



FLOATING PRODUCT

BAHIA FLOATING

FLOATING, POLARIZED AND HYDROFOBIC SUNGLASSES

Bahia Floating sunglasses are an essential companion for water sports thanks to their ability to float. Polarised lenses with UV protection and anti-reflective treatment offer clear vision, reduce glare and protect the eyes from harmful rays. With wrap-around temples, they fit comfortably during action. In addition, they come with a practical hard case for protection. These glasses combine safety

and style, making water sports a more enjoyable experience. With Bahia sunglasses, you will not only be fashionable, but enjoy clear vision while floating carefree on the water.

TECHNICAL FEATURES

- Ideal sunglasses for water sports
- Anti-glare polarized lenses with UV protection
- Water Repellent Hydrophobic
- Equipped with a practical hard case

- Lenses**
- Protective
 - Polarized
 - Antireflection



BLACK MIRRORED/BLUE



BLACK MIRRORED/SILVER



CHARCOAL MIRRORED/BLUE



COLOR	CODE	RRP €
BLACK/BLUE MIRRORED LENSES	XDB100701	39,99
BLACK/SILVER MIRRORED LENSES	XDB100704	39,99
CHARCOAL/BLUE MIRRORED LENSES	XDB100707	39,99



POLARIZED LENSES



HYDROPHOBIC LENSES



FLOATING PRODUCT

ROCKER FLOATING

FLOATING, POLARIZED AND HYDROFOBIC SUNGLASSES

The rocker was created to protect the view near water. They provide 100% protection from UV rays, blocking light reflections and glare. They guarantee clear vision and contrast. Thanks to the wrh treatment (water repellent and hydrophobic) the lenses stay clean. The anti-reflective coating

is appreciated while driving as it strongly reduces reflections from the asphalt and improves vision. Indispensable at the sea, on the beach, on a boat or when sailing.

HIGH-QUALITY ORGANIC GLASS LENSES

REPELS DIRT AND IS EASY TO CLEAN

COMFORTABLE AND DURABLE FRAME

TECHNICAL FEATURES

- Designed in Italy By Cressi, a real Italian family owned company that since 1946 provides the best quality Products in scuba, snorkelling, swimming, Spearfishing and freediving
- Lightweight and ultra flexible sunglasses for everyday city life and free time outdoor in nature
- Polarized and high quality Shatterproof Lenses made of polycarbonate with 100% UV protection and compact eyeglass temples
- High wearing comfort thanks to the soft rubber coating; available coloured lenses
- Functional and elegant supplied rigid case



BLACK MIRRORRED/BLUE



BLACK SMOKED



COLOR	CODE	RRP €
BLACK MIRRORRED LENS BLUE	XDB100502	39,99
BLACK SMOKED LENS	XDB100503	39,99



BLAZE

SATIN FINISHED

COLORED, MIRRORRED LENSES

10 PROTECTIVE LAYERS

HIGH-QUALITY ORGANIC GLASS LENSES

REPELS DIRT AND IS EASY TO CLEAN

COMFORTABLE AND DURABLE FRAME

POLARIZED AND HYDROFOBIC SUNGLASSES

Blaze sunglasses are the essential accessory for summer adventures. Perfect for the beach, boating, sup and water sports, these polarised and hydrophobic lenses eliminate glare and protect the eyes from bright light and water. Coloured lenses not only add style, but also improve visual perception. The lightweight frame is weightless

and offers a comfortable fit. In addition, the anti-reflective coating ensures clear vision. With Blaze sunglasses, you combine functionality with high fashion, ensuring excellent protection and style on every summer adventure.

TECHNICAL FEATURES

- Features**
- High-quality organic glass lenses
 - Polarising filters
 - Repels dirt and is easy to clean
 - HTC treatment
 - Comfortable and durable frame
 - Satin finished
 - Essential when boating and in the surf
 - Colored, mirrored lenses

- Lenses**
- Polycarbonate
 - Protective
 - Polarized
 - Antireflection



MATT BLUE/MIRRORED BLUE



MATT BLACK/MIRRORED BLUE



MATT BLACK/MIRRORED GREEN

COLOR	CODE	RRP €
MATT BLUE MIRRORRED BLUE	XDB100310	49,99
MATT BLACK MIRRORRED BLUE	XDB100313	49,99
MATT BLACK MIRRORRED GREEN	XDB100314	49,99



NINJA

100% UV PROTECTION

HIGH-QUALITY SHATTERPROOF

POLARIZED FILTER 3 CATEGORY

SOFT RUBBER COATING



POLARIZED AND HYDROFOBIC SUNGLASSES

Ninja sunglasses have been specially designed by CRESSI to protect your eyesight in the proximity of water. Cressi Ninja solar filters ensure 100% protection from UV rays, block dazzling reflections and glare, making for ultra clear, well-contrasted vision. Thanks to the WRH treatment that makes them water-repellent and hydrophobic, the lenses remain clean at all times, yet another feature that

makes these glasses indispensable when boating or sailing. The antireflection treatment also comes in handy when driving, in that it drastically reduces reflection from the asphalt and improves vision. Highly appreciated in the traditional version with black temples, they are now proposed in a mimetic version, renewing the success that made them famous.

TECHNICAL FEATURES

- Ideal sunglasses for water sports
- Anti-glare polarized lenses with UV protection
- Water Repellant Hydrophobic
- Equipped with a practical hard case

- Lenses**
- Protective
 - Polarized
 - Antireflection



BLACK



BLACK MIRRORED/BLUE



BLACK MIRRORED/GREEN



SHINY BLACK

COLOR	CODE	RRP €
BLACK	DB100001	29,99
BLACK MIRRORED LENS BLUE	DB100006	29,99
BLACK MIRRORED LENS GREEN	XDB100011	29,99
SHINY BLACK	XDB100001	29,99





100% UV PROTECTION | HIGH-QUALITY SHATTERPROOF | POLARIZED FILTER 3 CATEGORY

SNIPER

POLARIZED AND HYDROFOBIC SUNGLASSES

Cressi Sniper sunglasses have superior optical quality; they block reflections and protect against up to 100% of UV rays. They offer sharp vision that's rich in detail while increasing visual contrast. They protect the eyes from solar radiation, filter

out glare, and improve vision. Polarized lenses. Available in a broad assortment of Colors. The mirrored lenses are coated with CRT (Cressi Revo Treatment) which improves mirroring and offers excellent performance in all light conditions.



TECHNICAL FEATURES

- Sportive design
- Anti-glare treatment
- Sharp, high-contrast vision
- Wrap-around and comfortable frame

- Lenses**
- Protective
 - Polarized
 - Antireflection



The mirrored lenses mounted on these glasses are treated with advanced REVO coatings that return excellent performance in different light conditions and in any environment. The mirroring of the lens guarantees the maximum possible brightness and a high-definition lens.

Cressi sunglass lenses are designed to protect your eyes from the sun, including near the water, and they shield against all UV rays, so you can savor the sunshine while enjoying comfortable vision. If your eyes are sensitive to the light, choose a dark shade. Lighter and gradient lenses are perfect for cloudy skies with little sunlight, while darker lenses protect your eyes in bright sunlight.



BLACK MIRRORED/BLUE



BLACK MIRRORED/ORANGE



WHITE MIRRORED/BLUE



COLOR	CODE	RRP €
BLACK MIRRORED LENS BLUE	XDB100521	39,99
BLACK MIRRORED LENS ORANGE	XDB100522	39,99
WHITE MIRRORED LENS BLUE	XDB100530	39,99



POLARIZED LENSES



HYDROPHOBIC LENSES

HUNTER

POLARIZED AND HYDROPHOBIC SUNGLASSES

Cressi Hunter sunglasses have superior optical quality; they block reflections and protect against up to 100% of UV rays. They offer sharp vision that's rich in detail while increasing visual contrast. They protect the eyes from solar radiation, filter

out glare, and improve vision. Polarized lenses. Available in a broad assortment of Colors. The mirrored lenses are coated with CRT (Cressi Revo Treatment) which improves mirroring and offers excellent performance in all light conditions.

100% UV PROTECTION

HIGH-QUALITY SHATTERPROOF

POLARIZED FILTER 3 CATEGORY

SOFT RUBBER COATING

TECHNICAL FEATURES

- Anti-glare treatment
- Sharp, high-contrast vision
- Available with filters in different Colors
- High-quality shatterproof lenses
- Equipped with a practical hard case

- Lenses**
- Protective
 - Polarized
 - Antireflection

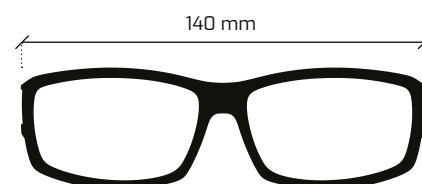

BLACK SMOKED



CARBON SMOKED



GREY MIRRORRED/BLUE



COLOR	CODE	RRP €
BLACK/SMOKED LENSES	XDB100450	39,99
CARBON SMOKED LENS	XDB100459	39,99
GREY MIRRORRED LENS BLUE	XDB100460	39,99



POLARIZED LENSES



HYDROPHOBIC LENSES

100% UV PROTECTION

HIGH-QUALITY SHATTERPROOF

POLARIZED FILTER 3 CATEGORY

SOFT RUBBER COATING

RIO

NEW COLOR 2025

POLARIZED AND HYDROFOBIC SUNGLASSES

Cressi's Rio sunglasses offer superior optical quality, ensuring a clear and detailed view as you dive into the water action. Ideal for water sports, boating and summer walks, these polarised lenses block out annoying glare and protect against aggressive UV rays. With an anti-reflective coating, they increase visual contrast, reducing eye fatigue.

Available in a variety of colours and coloured filters, the Rio meet every need. Whether you're surfing the waves or just strolling in the sun, cool, youthful and trendy, these glasses offer you clear vision, comfort and style.



NEW

MATT BLACK/ORANGE



BLUE MIRRORRED/BLUE



RED MIRRORRED/RED



BLACK/BLUE



BLACK/DARK GREY



BLACK/GREEN



BLACK/YELLOW

COLOR	CODE	RRP €
CRYSTAL BLUE/MIRRORRED LENS BLUE	XDB100107	24,99
CRYSTAL RED/MIRRORRED LENS RED	XDB100110	24,99
BLACK/BLUE LENS	XDB100111	24,99
BLACK/DARK GREY LENS	XDB100114	24,99
BLACK/GREEN LENS	XDB100112	24,99
BLACK/YELLOW LENS	XDB100113	24,99
MATT BLACK REVO ORANGE LENS	XDB100118	24,99

TECHNICAL FEATURES

- Ideal for leisure and life outdoors
- Anti-glare treatment
- Polarised lenses
- Sharp, high-contrast vision
- Available with filters in different colours

Quality Cressi sunglasses have superior optical quality; they block reflections and protect against UV rays. They offer sharp vision that is rich in detail and increases contrast, protecting the eyes from harmful rays. This combination improves comfort and decreases eye fatigue.

Filters The polarizing filter in the Cressi sunglasses guarantees sharp vision free of reflections and glare. Cressi polarised sunglasses block harmful sunlight reflected from horizontal surfaces, such as water or a road surface, while allowing vertical light to reach the eye. Vertical light is important for human eyes and improves vision.

UV Rays Cressi sunglass lenses are designed to protect your eyes from the sun, including near the water, and they shield against all UV rays, so you can savour the sunshine while enjoying comfortable vision. If your eyes are sensitive to the light, choose a dark shade. Lighter and gradient lenses are perfect for cloudy skies with little sunlight, while darker lenses protect your eyes in bright sunlight.

- Lenses**
- Protective
 - Polarized
 - Antireflection





100% UV PROTECTION

HIGH-QUALITY SHATTERPROOF

POLARIZED FILTER 3 CATEGORY



KIDDO

KIDS SUNGLASSES, AGE 6+

The Cressi Kiddo sunglasses for children fit comfortably. They block reflections and protect against up to 100% of UV rays. They offer sharp vision that's rich in detail while increasing visual contrast. They protect the eyes from solar radiation, filter out glare, and improve vision.

Polarized lenses. Available in a broad assortment of colours. The mirrored lenses are coated with CRT (Cressi Revo Treatment) which improves mirroring and offers excellent performance in all light conditions.

TECHNICAL FEATURES

- High quality lenses
- Anti-glare treatment
- Sharp, high-contrast vision
- Microfibre glasses and eyewear bag

- Lenses**
- Protective
 - Polarized
 - Antireflection

The mirrored lenses mounted on these glasses are treated with advanced REVO coatings that return excellent performance in different light conditions and in any environment. The mirroring of the lens guarantees the maximum possible brightness and a high-definition lens.

Cressi sunglass lenses are designed to protect your eyes from the sun, including near the water, and they shield against all UV rays, so you can savor the sunshine while enjoying comfortable vision. If your eyes are sensitive to the light, choose a dark shade. Lighter and gradient lenses are perfect for cloudy skies with little sunlight, while darker lenses protect your eyes in bright sunlight.

The polarizing filter in the Cressi sunglasses guarantees sharp vision free of reflections and glare. Cressi polarized sunglasses block harmful sunlight reflected from horizontal surfaces, such as water or a road surface, while allowing vertical light to reach the eye. Vertical light is important for human eyes and improves vision.

Cressi sunglasses have superior optical quality; they block reflections and protect against UV rays. They offer sharp vision that is rich in detail and increases contrast, protecting the eyes from harmful rays. This combination improves comfort and decreases eye fatigue.



ROYAL MIRRORRED/BLUE



KILLER WHALE/SMOKED

COLOR	CODE	RRP €
KILLER WHALE/SMOKED LENS	XDB100442	24,99
ROYAL/MIRRORRED LENS BLUE	XDB100444	24,99



/ SUNGLASSES

TEDDY



KIDS SUNGLASSES, AGE 3-5

Created specifically to protect vision near water. The sun filters of these glasses protect 100% from UV rays, block bright reflections and glare, guaranteeing a sharp and contrasted vision.

TECHNICAL FEATURES

- Optimal comfort
- Designed for children
- Supplied rigid case

- Lenses**
- Protective
 - Polarized
 - Antireflection

100% UV PROTECTION | 3-5 YEARS



WAVES MIRRORRED/BLUE



FISHES MIRRORRED/BLUE



PINK/SMOKED

COLOR	CODE	RRP €
WAVES/MIRRORED LENS BLUE	XDB100431	19,99
FISHES/MIRRORED LENS BLUE	XDB100432	19,99
PINK/SMOKED LENS	XDB100434	19,99



SUNGLASSES FLOATING LACE



FLOATING

CODE	*CASE PACK	RRP €
XDZ101050	10	9,99

EYEWEAR FLOATING NEO RETAINER



FLOATING



PRODUCT	CODE	RRP €
YELLOW	DQ031050	14,99
BLUE	DQ032730	14,99
BLACK	DQ035010	14,99



WFLATABLESUP

ELEMENT

ALL ROUND ISUP SET

Minimalism and pure lines, combined with the quality of Cressi DWF technology, give rise to a classic, no-frills inflatable SUP for paddling purists. The All Round shape, with rounded nose and flat tail, provides great maneuverability and stability. The nose rocker (curved bow) improves buoyancy by preventing the tip of the board from plunging

into choppy waters, making Element perfect for sea use. The large diamond-patterned pad offers a spacious walkable area and optimal grip, even when barefoot in the water.

Element is a ready-to-use set, easy to inflate (in under 10 minutes), carry and store thanks to the practical backpack supplied: a space-saving

solution equipped with all the accessories you need to go stand-up paddleboarding with peace of mind. Available in different sizes, it's suitable for all levels of experience and build.

- EASY TO INFLATE
- READY-TO-USE SET
- ALL ROUND SHAPE
- PURE & MINIMAL DESIGN

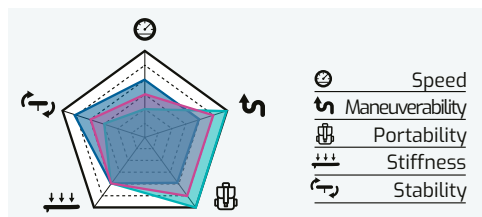

ELEMENT 10'2''

Length	310 cm	10'2"
Width	81 cm	32"
Thickness	15 cm	6"
Volume	300 l	
Max press.	15 PSI	1 BAR
Inflation	8 minutes	
Max load	120 kg	264 lbs
Board weight	9 kg (± 0.2)	20 lbs
Set weight	13 kg (± 0.2)	28,5 lbs
Technology	DWF	
N° Chambers	1	
Fin Box	US Fin Box	
Fin	US 8"	
Valve	HP Valve	
Box dimensions	40x88x26 cm	

ELEMENT SMALL 8'2" SET INCLUDES:

- Element ISUP 8'2" (x1)
- MOD3 Paddle (x1)
- Mini Quick Skeg Fin 7" (x1)
- Coiled Leash 10' (x1)
- EXA 120l Backpack (x1)
- Welter Pump (x1)
- Repair Kit (x1)
- User Manual (x1)

ELEMENT SMALL 9'2" SET INCLUDES:

- Element ISUP 9'2" (x1)
- MOD3 Paddle (x1)
- US Skeg Fin 8" (x1)
- Coiled Leash 10' (x1)
- EXA 120l Backpack (x1)
- Welter Pump (x1)
- Repair Kit (x1)
- User Manual (x1)

ELEMENT SMALL 10'2" SET INCLUDES:

- Element ISUP 10'2" (x1)
- MOD3 Paddle (x1)
- US Skeg Fin 8" (x1)
- Coiled Leash 10' (x1)
- EXA 120l Backpack (x1)
- Welter Pump (x1)
- Repair Kit (x1)
- User Manual (x1)



PRODUCT	CODE	RRP €
ELEMENT ISUP SET WHITE/BLUE 10'2"	NA001032	329,99

ELEMENT

ISUP CONSTRUCTION

CONSTRUCTION USED IN:
 Element Small All Round 8'2"
 Element All Round 9'2"
 Element All Round 10'2"



CRESSI
HYDROSPORTS

Double Wall Fabric

Element boards are made with Cressi DWF (Double Wall Fabric) technology, an airtight multilayer (1) material whose internal fibers (2) give it a perfectly flat and rigid surface once inflated. The double-layer rail (3) with variable thickness guarantees excellent performance during use but is easy to roll up, for a board that's durable and easy to use.

DWF CORE

Weight	2700 g/sq.m
Threads Height	150 mm
Nominal Layers	Single

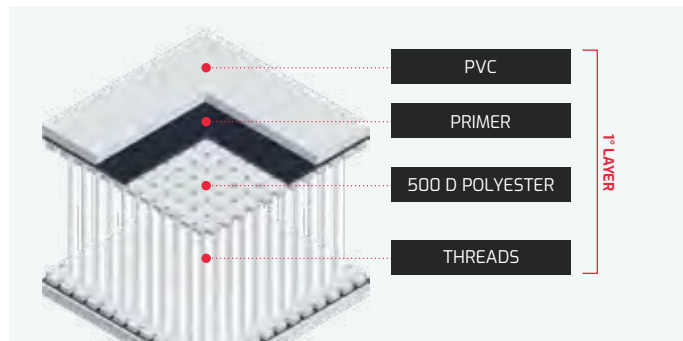

BALANCE RAIL

Thickness	1.2 mm
Nominal Layers	Double

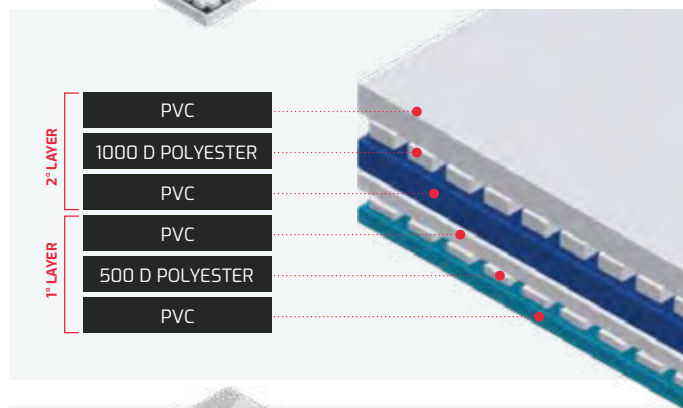

DECK PAD

Thickness	5 mm
Pattern	Diamond

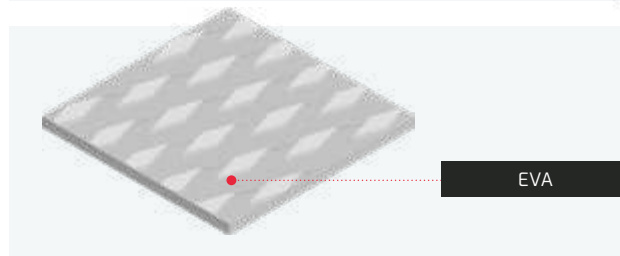

Photo by: Lluís Masuet

SOLID

RENTAL ISUP

Solid is the Cressi Hydrosports SUP family designed specifically for professional rental.

The use of Double Chamber Reinforced PLF technology and triple-layer anti-abrasion rail (the most resistant and robust composition in the whole collection) guarantee maximum structural stiffness and great safety during sessions at sea.

The board is available in the All Round version with

one seat and Tandem with two seats. Due to their intended professional use, the two versions of Solid have features designed to improve the experience of both the boards' end users and those who rent them. Numerous D-rings and handles are positioned along Solid's structure to facilitate hooking and transport.

Furthermore, each side features special dedicated

- DESIGNED FOR RENTAL ACTIVITY
- REINFORCED RAIL MATERIAL
- DOUBLE CHAMBER ISUP BOARD
- MAX SAFETY HIGH STIFFNESS

HIN (Hull Identification Number) spaces for customized numbering by the rental center. The US Click 9" fins supplied have a quick coupling and release system, with a variable-intensity locking system.

Each board will be accompanied by a Trailer Leash, a reinforced elastic rope with double S-shape carabiner, useful for towing and mooring.



Solid is equipped with US Quick Skeg Fin 9" with fast locking system:

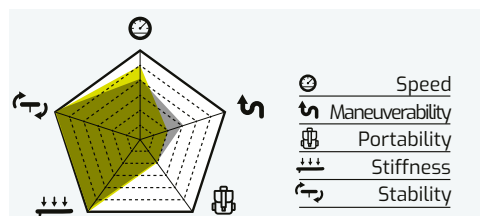

ALL ROUND 10'6"

Length	323 cm	10'6"
Width	81 cm	32"
Thickness	15 cm	6"
Volume	310 l	
Max press.	15 PSI	1 BAR
Inflation	8 minutes	
Max load	125 kg	275 lbs
Board weight	10,5 kg (± 0,2)	23 lbs
Set weight	11,3 kg (± 0,2)	25 lbs
Technology	DC PLF reinforced	
N° Chambers	2	
Fin Box	US Fin Box	
Fin	US Quick 9"	
Valve	HP Valve (x2)	
Box dimensions	40x88x18 cm	



Thanks to the Trailer Leash supplied, it will be possible to easily and quickly connect the boards through the D-Rings positioned at the bow and stern, so as to be able to keep all the boards under control during each tours.

- SOLID 12'2" SET INCLUDES:**
- Solid ISUP 12'2" (x1)
 - US Quick Skeg Fin 9" (x2)
 - Trailer Leash 8' (x1)

PRODUCT	CODE	RRP €
SOLID ALL ROUND DC ISUP GREY/FLUO 10'6"	NB011070	399,99

SOLID

ISUP CONSTRUCTION

CONSTRUCTION USED IN:
 Solid All Round 10'6"
 Solid Tandem 12'2"



CRESSI
 HYDROSPORTS

Double Chamber
 PLF Reinforced

Triple-layer reinforced rail (1) with external anti-abrasion coating, for longer-lasting boards when subjected to greater stresses from prolonged use during rental. The double air chamber core (2) made of pre-laminated material with

a dedicated valve gives the user high stiffness and safety in case of air leaks caused by accidental punctures.

PLF CORE

Weight	3100 g/sq.m
Threads Height	150 mm
Nominal Layers	Double

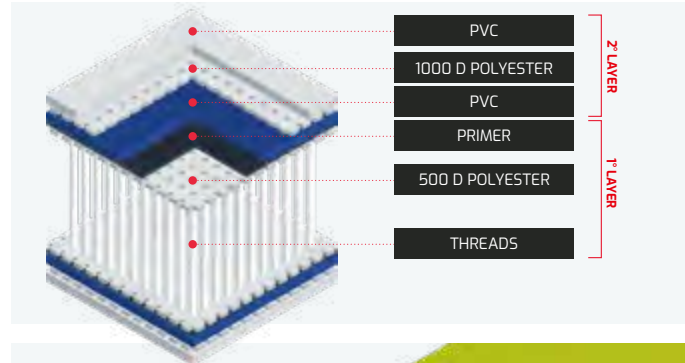

RAINFORCED RAIL

Thickness	1.9 mm
Nominal Layers	Triple

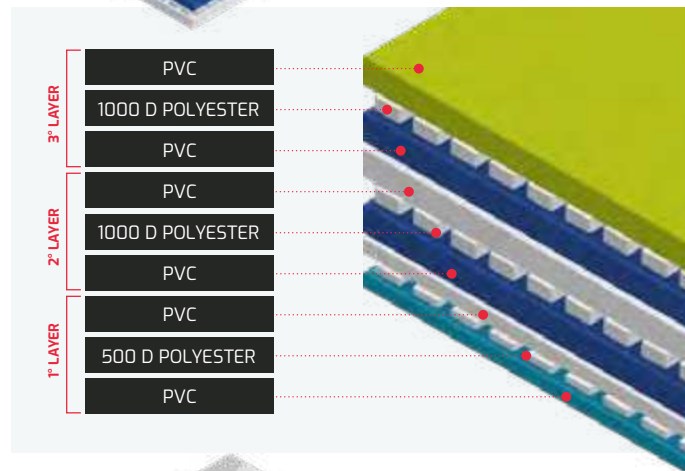

DECK PAD

Thickness	5 mm
Pattern	Diamond

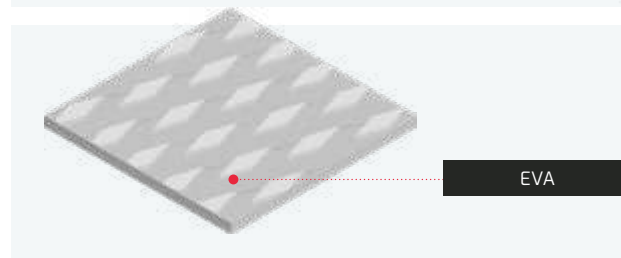

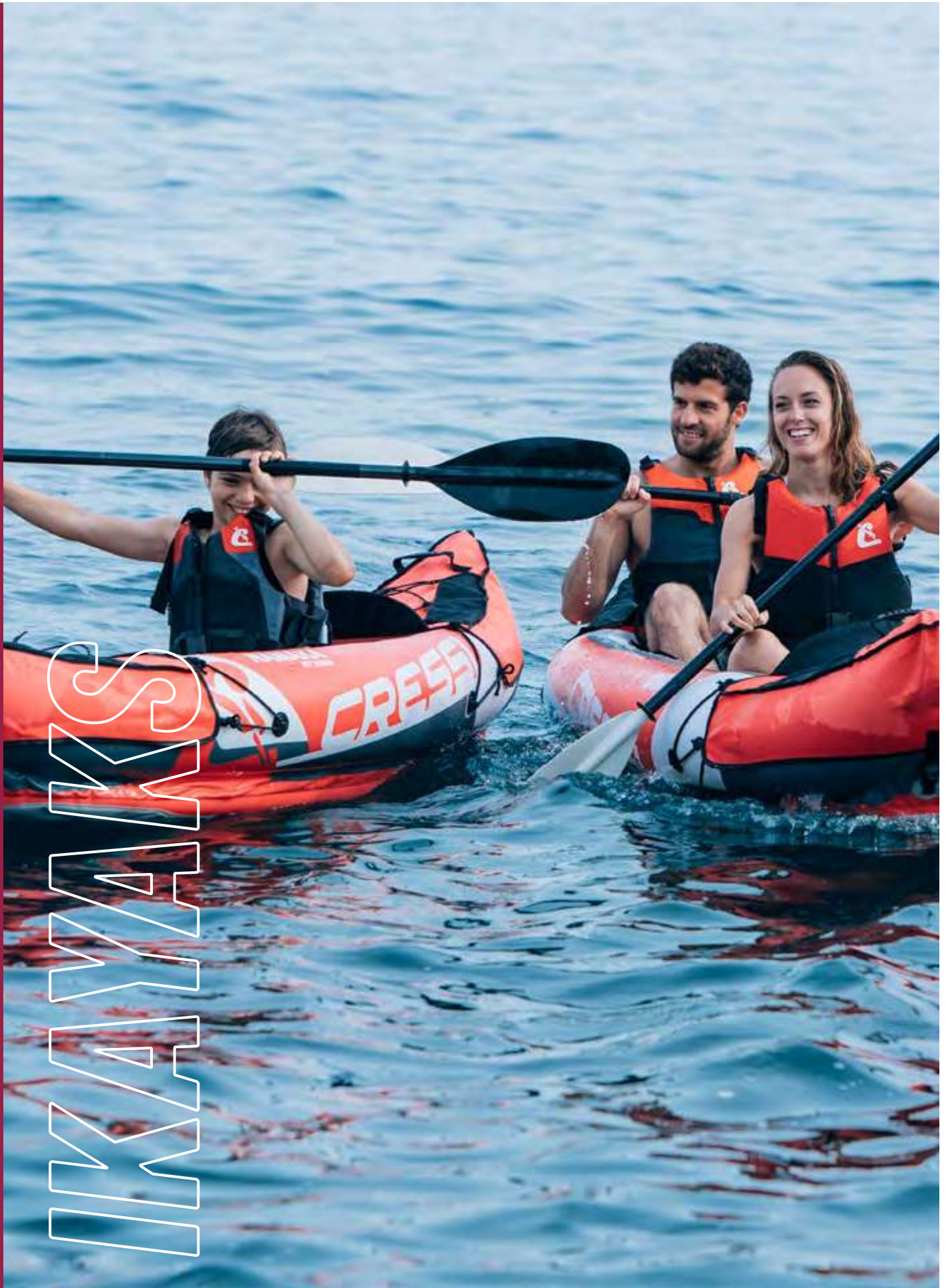

IKAYAKS

NAMAKA

IKAYAK SET

Namaka is the Cressi kayak created to explore the coasts and nature, to move silently and reach places inaccessible by sailing or swimming, with zero emissions and the utmost respect for the marine environment.

Namaka is an inflatable kayak with excellent stability thanks to its air chambers with tubular sections, which are ideal for following the waves. Comfort is ensured by the inflatable seats that provide a raised paddling position, while the velcro strips and adjustable straps allow the lumbar support to be moved and adapted along the entire cockpit. Namaka is equipped with nylon linings at the bow and stern with splash guards, practical bungee cords, handles to help carry it out of the water, a velcro oar holder and reinforced bottom

with anti-abrasion layer.

It is a ready-to-use set, supplied with all the accessories needed for inflation and immediate use, from the pump to the paddle up to the quick-hooking fins.

EASY TO INFLATE AND DEFLATE

ADJUSTABLE SEAT POSITION

REINFORCED BASE

READY-TO-USE SET

TECHNICAL FEATURES

Made of hermetic 1000-denier weft multilayer material to provide the best stiffness/weight ratio. Lateral tubular air chambers with dedicated valves and reinforced anti-abrasion compartment base. Lightweight construction for maximum comfort and performance.

Certified according to the international quality and safety standard ISO 6185-1 III B.



SINGLE SEAT 8'2"

Length	250 cm	8'2"
Width	80 cm	31"
Volume	240 l	
Max press.	0,8 PSI	0,05 BAR
Inflation	7 minutes	
Max load	100 kg	220 lbs
Kayak weight	9 kg (± 0.2)	20 lbs
Set weight	12,5 kg (± 0.2)	27 lbs
Technology	TubeLight	
N° Chambers	3	
Fin	LOCK'N GO 8"	
Valve	RQR Valve (x2) SQR Valve (x1)	
Box dimensions	45,7x63,5x22,9 cm	

8'2" SET INCLUDES:

- Namaka IKayak 8'2" (x1)
- MOD4 Paddle (x1)
- Lock'n Go Skeg Fin 8" (x1)
- PENTA 90L Backpack (x1)
- Air Pump (x1)
- User Manual(x1)

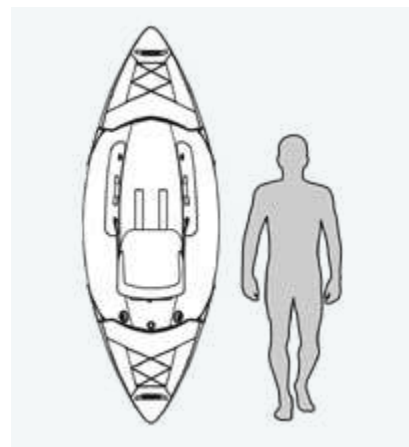

PRODUCT	CODE	RRP €
NAMAKA SINGLE SEAT IKAYAK SET RED 8'2"	NC000880	299,99

ISUP & IKAYAKS ACCESSORIES



PVC REPAIRING GLUE



CODE	RRP €
NZ000400	12.99

DESCRIPTION:
Polyurethane adhesive for pvc patches, ideal for puncture repairing.

SUITABLE FOR:
All Cressi Hydrosports ISUP boards and IKayaks.

REPAIR KIT



CODE	RRP €
NY000000	22.99

DESCRIPTION:
Kit composed of PVC patches and HP valve wrench. ! GLUE NOT INCLUDED !

SUITABLE FOR:
All Cressi Hydrosports ISUP boards.

BUNGEE CORD

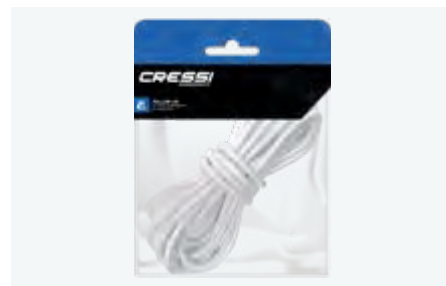

CODE	RRP €
NZ000500	12.99

DESCRIPTION:
White elastic bungee cord for isup cargo area, 3 meters length, 5 mm diameter.

SUITABLE FOR:
All Cressi Hydrosports ISUP boards.

DIVER DOWN FLAG



CODE	RRP €
NT611100	9.99

DESCRIPTION:
Diver down flag + removable flagpole

SUITABLE FOR:
Tiger Shark Multitask 10'2" ISUP.

HATCH COVER



CODE	RRP €
NZ003080	36.99

DESCRIPTION:
Hatch cover made of sturdy PVC fabric, equipped with mesh pocket and snap hooks for quick fastening at D-Rings.

SUITABLE FOR:
Tiger Shark Multitask 10'2" ISUP.

HP VALVE



CODE	RRP €
NZ000303	22.99

DESCRIPTION:
High pressure valve with PUSH-PUSH opening, equipped with ergonomic cap and protective mesh filter.

SUITABLE FOR:
All Cressi Hydrosports ISUP boards.



SKEG FINS

DURABLE MATERIALS | NO-TOOLS REQUIRED | EASY ASSEMBLING



US SKEG FIN 9"

Maneuverability	●●○○○
Roll Stability	●●●●●
Draft	230 mm 9"
Material	Nylon
Fin Box	US Fin Box
Locking system	Threaded Pin
Box dimensions	30x2x28 cm

DESCRIPTION:
9" (23 cm) keel fin for SUP and longboard made of elastic Nylon plastic feature a threaded pin for tool-less closure. Ideal for touring and race boards to keep straight trajectories and high stability.

SUITABLE FOR:
Element All Round 9'2" ISUP
Element All Round 10'2" ISUP
Reef Window 10'2" ISUP
Fluid All Round 10'2" ISUP
Jet Cruise ISUP 11'2"
Tiger Shark Multitask 10'2" ISUP
Fury Touring 12'2" ISUP
Solid All Round 10'6" ISUP
Solid Tandem 12'2" ISUP

SPARE PARTS:
US Skeg Fin Screw



US QUICK SKEG FIN 9"

Maneuverability	●●●○○
Roll Stability	●●●●○
Draft	230 mm 9"
Material	Nylon + TPU (Pads)
Fin Box	US Fin Box
Locking system	Pads
Box dimensions	26,5x2x24,5 cm

DESCRIPTION:
9" (23 cm) keel fin for SUP and longboard made of elastic Nylon plastic feature the US QUICK system to adjust the intensity of the coupling according to the number of pads placed in the apposite housings. Ideal for rental boards for a faster in-water entrance and warehouse storage.

SUITABLE FOR:
Element All Round 9'2" ISUP
Element All Round 10'2" ISUP
Reef Window 10'2" ISUP
Fluid All Round 10'2" ISUP
Jet Cruise 11'2" ISUP
Tiger Shark Multitask 10'2" ISUP
Fury Touring 12'2" ISUP
Solid All Round 10'6" ISUP
Solid Tandem 12'2" ISUP



MINI QUICK SKEG FIN 7"

Maneuverability	●●●●●
Roll Stability	●●○○○
Draft	178 mm 7"
Material	TPU
Fin Box	Mini Quick Fin Box
Locking system	Click
Box dimensions	26x2x19 cm

DESCRIPTION:
7" (18 cm) keel fin for SUP and longboard made of semi-rigid TPU plastic, feature MINI QUICK coupling / release system. Ideal for compact boards with twin-fin configuration for maximum maneuverability.

SUITABLE FOR:
Element Small All Round 8'2" ISUP
Travelight Foldable 9'2" ISUP



CODE	RRP €
N0000009	27,99



CODE	RRP €
N0000109	34,99



CODE	RRP €
N0000207	34,99



PADDLES

MOD3 SUP PADDLE

MOD5 SUP PADDLE



HAIKILI SKEG FIN 9"

Maneuverability	●●●○○
Roll Stability	●●●●○
Draft	230 mm 9"
Material	Nylon
Locking system	Clip

DESCRIPTION:
9" (23 cm) fin for SUP and longboard made of elastic Nylon plastic. Made for Haikili ISUP.

SUITABLE FOR:
Haikili iSUP Set 10'6"



Max Height	215 cm	84"
Min Height	165 cm	64"
Disassembled	89 cm	35"
N° of modules	3	
Materials	Aluminum and Nylon	
Blade dimensions	47x18 cm	18"x7"
Paddle Weight	990 g	
Box dimensions	20x6x90 cm	

Max Height	218 cm	86"
Min Height	185 cm	73"
Disassembled	50 cm	19"
N° of modules	5	
Materials	Aluminum and Nylon	
Blade dimensions	42x20 cm	16"x8"
Paddle Weight	1100 g	
Box dimensions	22x8x52 cm	

DESCRIPTION:
Sturdy and versatile telescopic SUP paddle in 3 modules, suitable for all levels of experience. Floating and adjustable with centering and height notches, one-hand locking system. Aluminum handle and stainless button springs, reinforced nylon blade and handle.

SUITABLE FOR:
All Cressi Hydrosports ISUP boards.

DESCRIPTION:
Telescopic SUP paddle in 5 modules, designed for those who need to transport it in compact backpacks. Floating and adjustable with centering and height notches, one-hand locking system. Aluminum handle and stainless button springs, reinforced nylon blade and handle.

SUITABLE FOR:
All Cressi Hydrosports ISUP boards.

CODE		RRP €
XVZ000008		24,99

US SKEG FIN BOX



CODE		RRP €
NZ000001		26,99

DESCRIPTION:
Cressi fin base with US coupling system, made of high-strength polycarbonate to bolster flexion caused by lateral currents.

SUITABLE FOR:
US Skeg Fin 8" - 9"
US QUICK Skeg Fin 9"



CODE		RRP €
NM035020		59,99



CODE		RRP €
NM055020		69,99

LEASH 10'

ISUP ANKLE LEASH

Extendable coil ankle leash (max 10') which won't get in the way while paddling. Made with TPU coil and neoprene anklet with steel insert to withstand the greatest stresses. Maximum comfort and safety for stand-up paddleboarding.

NEOPRENE ANKLET | STURDY TPU CORE COIL | DOES NOT IMPEDE DURING PADDLING

TECHNICAL FEATURES

Max. Length	305 cm	10'
Min. Length	100 cm	3'3"
Coil diameter	7 mm	
Ankle circumference	18-30 cm	7.2"- 12"
Box dimensions	8x30x8 cm	



PRODUCT	CODE		RRP €
TRAILER LEASH BLACK 10'	XVZ000005		29.99



TRAILER 8'

TOWING LEASH

Leash for towing and mooring SUP boards and Kayaks, made of elastic core coated with a sturdy polyester fabric. Its composition lets you paddling and towing without tugs. Feature quick attachment/release system on both sides thanks to the S-shape carabiners.



ANTI-TEAR ELASTIC CORE | S-SHAPE CARABINERS FOR QUICK LOCKING | ANTI-SINK FLOAT

TECHNICAL FEATURES

Max. Length	240 cm	8'
Min. Length	135 cm	4'4"
Carbiner	S-Shape (x2)	
Carbiner dimensions	9x4,5 cm	3.5"x 1.7"



PRODUCT	CODE	RRP €
TRAILER LEASH BLACK/RED 8'	NQ005095	25,99

SQUID

FOLDABLE ANCHOR

Foldable anchor designed for SUPs, kayaks and small inflatable boats. Squid's umbrella structure makes it easy to transport and store. Ideal for sandy, rocky and gravelly bottom conditions. Kit includes 10 meters of rope with float and hooking carabiner, padded case.



FOLDABLE DESIGN | IDEAL FOR SAND, ROCK AND GRAVELLY BOTTOM | ROPE, FLOAT, AND CARABINER INCLUDED

TECHNICAL FEATURES

Length	10 m	32'
Weight	1,6 kg	3.5 lb
Box dimensions	31,6x11,7x10,5 cm	



PRODUCT	CODE	RRP €
SQUID FOLDABLE ANCHOR SET RED 3.5 LBS	NS000000	49,99

CRESSI SPEARFISHING NEW COLLECTION

With this catalogue, we would like to highlight our origins, which have distinguished us over the years. Today, with the same passion as then, we follow the needs of our customers, from the beginners to the most ambitious athletes, sure of providing products suitable for all needs, always focusing on technology and results.

In these 79 years the company has always preserved its DNA, which is well represented by Cressi logo. The "C" logo with the mermaid, in the origin with the speargun, is recognisable all over the world as a prestigious brand of watersports and spearfishing.

Our goal is to provide a complete vision of our products Dedicated to all those who make spearfishing their passion.

The work undertaken over the years carries out a constant renewal of products with strict testing and always new technologies, placing us at the top for reliability, performance and durability.

All this takes in thanks to a continuous dialogue between our designers, who are always ready to make the best improvements, and our ambassadors, expert testers who have made the sea their home.

The philosophy of the Cressi family is always the same, first of all the technique and then everything else... this catalogue is an excellent example.



Photo by: Voyages of Agape



BORN FROM THE SEA

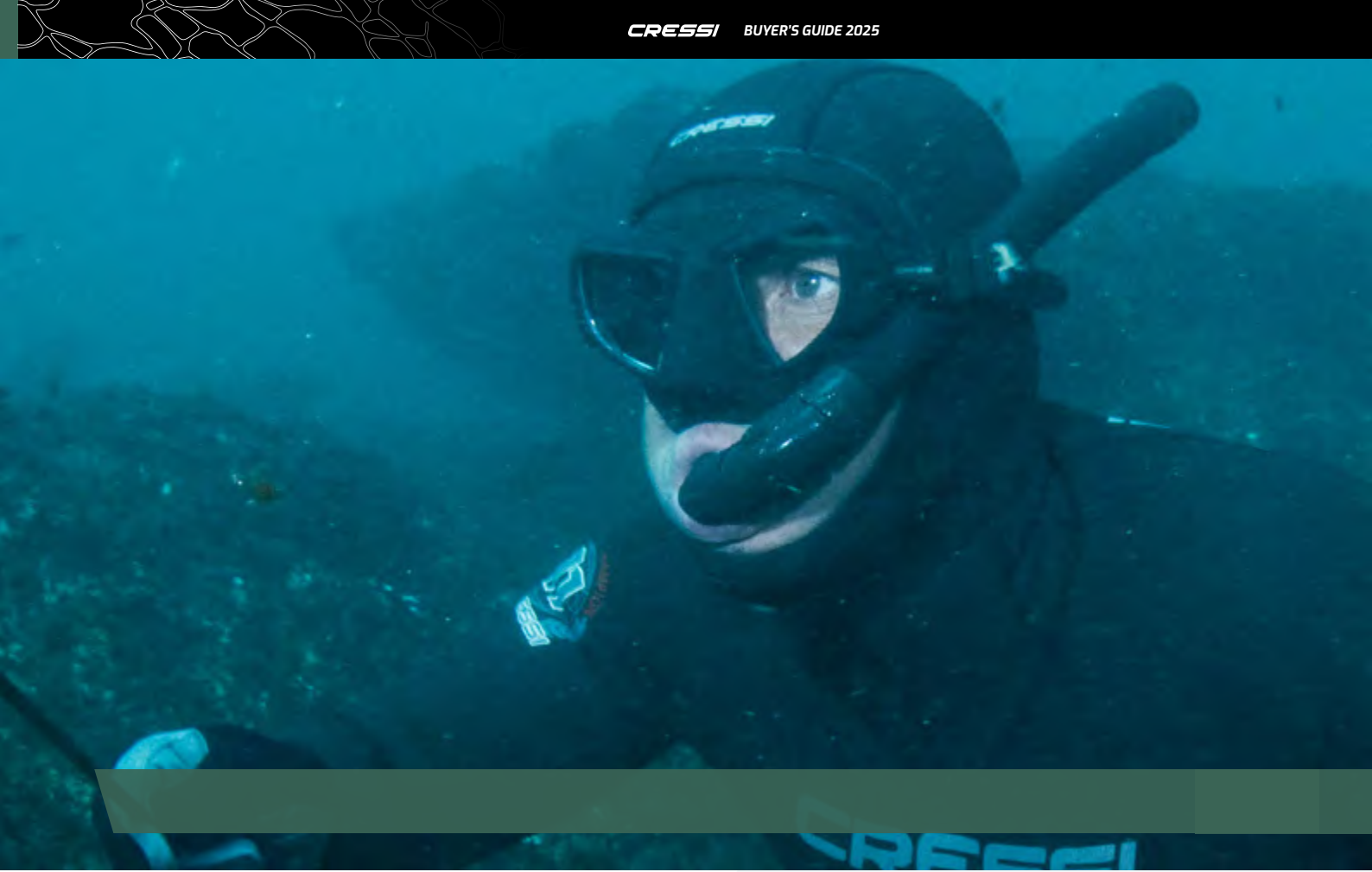

x12 TIMES SPEARFISHING WORLD CHAMPIONS!

CRESSI

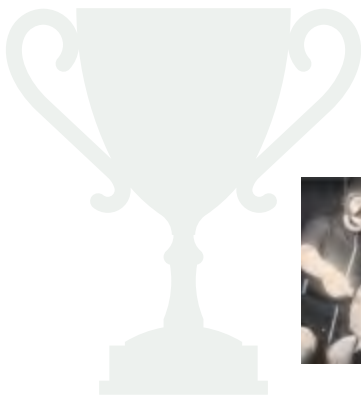

1ST WORLD SF CHAMPIONSHIP
1957, YUGOSLAVIA



CATALANI MARIO
60.140 POINTS

3RD WORLD SF CHAMPIONSHIP
1959, MALTA



LENTZ TERRY
53.050 POINTS

4TH WORLD SF CHAMPIONSHIP
1960, ITALY

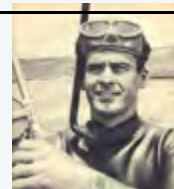

HERMANY BRUNO
47.320 POINTS

16TH WORLD SF CHAMPIONSHIP
1987, TURKEY

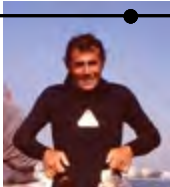

MAZZARI RENZO
138.555 POINTS

17TH WORLD SF CHAMPIONSHIP
1989, ITALY

MAZZARI RENZO
64.610 POINTS

18TH WORLD SF CHAMPIONSHIP
1992, SPAIN

MAZZARI RENZO
111.296 POINTS

24TH WORLD SF CHAMPIONSHIP
2004, CHILE



BELLANI STEFANO
76.320 POINTS

CRESSI

SPEARFISHING & SUSTAINABILITY

Spearfishing has become **the most sustainable fishing method** for many reasons. One of the biggest is that it has the most selective catch, by species, size, and quantity.

It also has the least problems for the environment, no by-catch, it doesn't need any bait, almost no gear loss, virtually no non-targeted species impact, and no harm to the surrounding **underwater environment**.

When using the Cressi gear and taking only high percentage shots, there is a low non-retrieval rate. **By following all fishing regulations and laws, and shooting only fish that are good to eat, and always eating your catch.**

Cressi cares to preserve the planet reducing its environmental impact.

WE CARE!

Egidio and Nanni Cressi first founded the Cressi company to service the growing sport of spearfishing, and the Cressi name has been associated with the sport ever since.

Cressi-sponsored athletes have **won 12 world spearfishing titles** in that time, and **15 Italian championships**.

The company offers an **extensive line of gear**. These include pneumatic and band-powered guns, masks, a lot of models of freediving fins and a wide range of accessories, such as bags, shafts, reels and so on.

6TH WORLD SF CHAMPIONSHIP
1963, BRASIL

HERMANY BRUNO

141.000 POINTS

10TH WORLD SF CHAMPIONSHIP
1971, CHILE

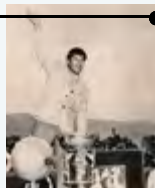

CHOQUE RAÚL

405.550 POINTS

27TH WORLD SF CHAMPIONSHIP
2010, CROATIA



DANIEL GOSPIC

41.484 POINTS

29TH WORLD SF CHAMPIONSHIP
2014, PERÙ



XAVIER BLANCO

28.191 POINTS

33TH WORLD SF CHAMPIONSHIP
2023, SPAIN



SANTI LÓPEZ

53.500 POINTS

MORE THAN ANYONE ELSE!

OUR PARTNERS





Mar sea **LOWRANCE** **CRESSI**
Continua evoluzione SINCE 1948

Both partnerships comes from a patrimony of **values shared**, which have always been oriented towards the design of products tailored to users and their needs, but are also united by a genuine passion for fishing and water, the natural element in which **Mar-sea and Lowrance** electronics express their maximum efficiency.

Mar sea
Continua evoluzione

Inflatable boats
 100% Made in Italy

📷 [marsea_alson](#)



LOWRANCE

Leader in Marine
 Electronics since 1957

📷 [lowrancefishing](#)



/ OUR AMBASSADORS

ANGELO ASCIONE



Angelo Ascione

I've had several successes in both national and international spearfishing competitions. I'm a freediving and spearfishing instructor, and today I'm constantly dedicated to this. I've always been fascinated by the aquatic world. The sea is my passion which is second only to my family.

STEFANO BELLANI



Stefano Bellani

Since I was young, in my free time I was always out at sea, in the blue waters of Corsica, fishing tunas and amberjacks. Constantly looking for new places to explore and to practise my passion. People calls me a real champion, I'm proud to have the opportunity to share my underwater world.

GIULIO CAVALIERE



giulio.knight

The fascination with the sea has been very strong since I was a child. I remember the excitement of handling mask and fins for the first underwater adventures and the Cressi brand that made people dream and gave them confidence. Over the years, freediving soon became a must and a priority, a lifestyle in the true sense of the word.

PHILIPPE CHARRIER



I was born in July 1977 in Cannes, France. I am a professional fisherman, I love the sea and every time is a new discovery. In 2001 I entered the world of Cressi, which has sponsored me ever since. I was on the French national underwater fishing team between 1999 and 2005.

KRISTIAN CORRIAS



Kristian Corrias

I'm very connected to the sea, it gives me sense of freedom even when it's rough and seems to want to push me away. I've always had the passion for spearfishing since I was a teenager. I waited impatiently for the specialized magazines to admire the champions of the time and read their stories.

LUCA DELLA SANTA



lucads13

I was raised on the beaches of North Carolina and South Florida, where my love for the ocean began. Growing up, I was fishing, diving, or surfing any chance I could get. With my love for the ocean and wanting to experience it in different ways, I have continued to share the passion for the sport.

FRANCESCO DIVERSI



diversifrancesco

Graduated in Molecular Biology in Pisa, where my passion for the sea began. Particularly for sailing, achieving success in national and international competitions, and for spearfishing. In 2008 I won the Italian team championship and in 2017 I started working with Cressi.

STJEPKO KESIC



Stjepko Kesic

I'm part of the Cressi team and won my first title as Croatian National Champion in 2019. Then I won my second title in 2020, a two days championship was held in the area of half island Istra and it was organized by the Club Delfin from Pula, it was a very satisfying experience.

STEFANO KONJEDIC

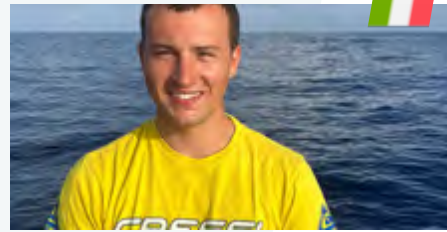

stefano_kojednic

Freediving, Spearfishing, and Finswimming instructor. Diver of the Italian Navy, European champion with World record and vice-champion, of freediving and finswimming. For many years he has competed for the Italian national swimming team. He gave vent to his passion for diving and spearfishing. In 2023, he entered the world of competitions, achieving several podiums at regional competitions; he was called for the Italian Championships in September 2023.

FRANCISCO LOFFREDI



franciscloffredi

Born and raised in Rio de Janeiro, Brazil, where I learned to fish. Spearfishing is a way of life, and my love for the sea has led me to be a proponent of sustainable spearfishing. I have won the biggest fish trophy at the Blue Water World Cup three times. In 2013, I won all three trophies of the World Cup: individual, team and biggest fish.

DARIO MACCIONI



dariomaccioni

Being part of the Cressi Team makes me proud, above all because since I was 8 years old my favourite brand for its colours, logo and the champions that represented it is Cressi Sub. My life is dedicated to my family and to spearfishing. I continue my competitive career giving my best with the hope that it will last as long as possible.

RENZO MAZZARRI



renzomazzarri.com

Renzo Mazzarri is an Italian freediving fisherman. He is the only one to have won **three consecutive world championships** in both individual and team fishing (1987 Turkey, 1989 Italy, 1992 Spain). He is capable of fishing at depths of more than 35 metres. In his career, he has collected a countless number of victories. In 1990 he received the Trident d'Or as the best diver of the year.

/ OUR AMBASSADORS

RICCARDO MOLTENI

Italy



Riccardo Molteni

Three times world champion in the Spearfishing Champions League with his adventure partner Mazzarri, Riccardo Molteni boasts an outstanding career. A world-traveller and admirer of the deep sea around the globe, in his stories he always manages to highlight the beauty of his experiences and also the inevitable risks involved, which are impossible to overcome without a pinch of madness and a lot of passion.

ANTONINO PIRAS

Italy



Antonino Piras (Nino)

When I was 12 years old the most important thing for me was to jump into the sea to see everything that was inside. I've turned this passion into my sport and I consider myself extremely lucky cause my passion has also led to my job as Cressis agent, which gives me satisfaction in being the team manager of this wonderful group of athletes.

FRANCESCO PIRAS

Italy



pirasf

My love for the water has been transmitted from father to son. Organising fishing expeditions is my greatest passion. I practice in all seasons and with different techniques, I live underwater all year round. In September 2016, in the waters of Taranto, I won the Italian Championship of Apnea Fishing Qualification (second category).

ANDREA SETTIMI

Italy



and_set_sea

A lifestyle and family tradition that I have experienced since I was 12 years old. The emotions and peace that I constantly feel underwater give me the strength to look ahead and set myself new goals. I love everything about freediving, from the difficulties to the satisfaction, and I always try to learn from it. The sea seems always to understand me.

SANTI LÓPEZ CID

Spain



Probably the most prestigious and recognised Spanish spearfisherman in the world. He has won 7 European Championships and 4 World Championships. He started spearfishing in Mallorca, when he found a speargun, a mask and a snorkel hidden in some bushes. Many call him "the magician" for his magical performances in championships that have left the other competitors speechless.

BE THE NEXT...



Join the Cressi family!

Our team is always looking for new talents and athletes who share our love for the sea!
 Contact us at:
 European countries - marketing.italia@cressi.com
 American countries - marketing@cressiusa.com







SPEARGUNS



VICTORY

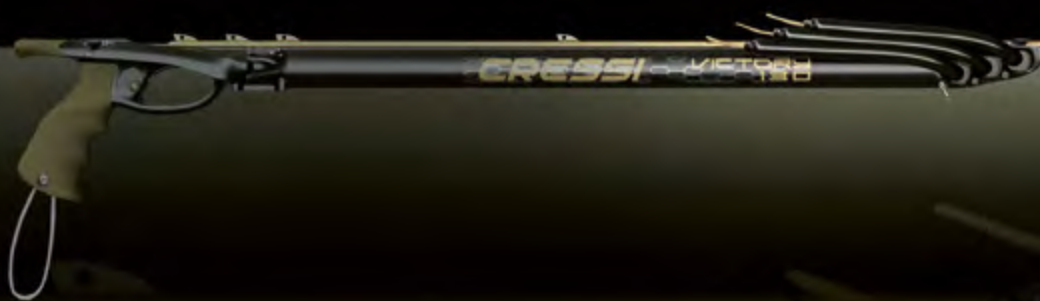

VICTORY SPEARGUN, FOR BIG GAME **SPEARFISHING** «

STEFANO PEDEMONTE
Technical Manager Spearfishing Division



MADE IN ITALY



WHY BUY IT?

The Victory will guarantee a better fishing experience thanks to its excellent recoil control and great shooting accuracy.

WHAT MAKES IT DIFFERENT?

The circular 31mm shaft is very rigid but provides excellent hydrodynamics in all directions, allowing smooth and fast movements in the water.

WHERE IS THE INNOVATION?

The shaft that is retained on the arbalete thanks to a Neodymium magnet on the head and the construction technique that allows for excellent balancing in the water.



VICTORY SPECIALIZED



FOR BIG GAME SPEARFISHING

The Cressi Victory fishing rifle is the ideal choice for fishing enthusiasts looking for a superior experience. With its excellent rebound control and great shooting accuracy, the Victory guarantees more effective and rewarding fishing. What makes the Victory rifle different from others is its 31 mm round body; despite its rigidity, it offers exceptional hydrodynamics in all directions. This allows smooth and fast movements in the water, enabling the angler to move nimbly and easily

to reach the best position and hit the target with precision. The result is a durable speargun that delivers exceptional performance, allowing the angler to meet challenges in the water with ease and precision. In summary, the Cressi Victory bungee speargun is a high-quality option for those wishing to enhance their fishing experience.



31 MM BARREL

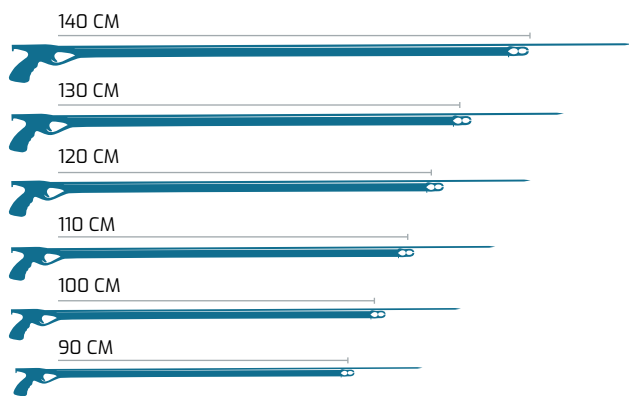

PRODUCT	CODE	RRP €
VICTORY RUBBER ARBALETE 90	FE380090	289,99
VICTORY RUBBER ARBALETE 100	FE380100	299,99
VICTORY RUBBER ARBALETE 110	FE380110	319,99
VICTORY RUBBER ARBALETE 120	FE380120	324,99
VICTORY RUBBER ARBALETE 130	FE380130	329,99
VICTORY RUBBER ARBALETE 140	FE380140	339,99

TECHNICAL FEATURES

- Control and precision
- Exceptional hydrodynamics
- Adaptability
- Shaft ø mm 7.5 with bottom flopper
- Triple circular band ø mm 14 with Dyneema SK78 wishbone



HYDRA

SHAFT Ø 7.5 MM



3X CLOSED CIRCULAR MUZZLE



TRIPLE CIRCULAR BAND Ø 14 MM WITH DYNEMA SK78 WISHBONE



31MM RIGID AND HYDRODYNAMIC ROUND BODY



SPECIAL HANDLE ANGLE TO INCREASE THE SHOTS' PRECISION



CHEROKEE POWER SPECIALIZED Retailer-Product



UNLIMITED POWER

Anticorrosal black frame with integrated spear guide, grip made of engineering plastic reinforced with glass fibre, interchangeable high or low sternal support. Ultra-light triggering case with trigger, release mechanism and line ring on the side in AISI 316, machined from solid with a CNC process. The shock absorber makes silent the release of the shaft. Reversible side-safety mechanism. Reinforced reel with steel pin buckle. Head for double elastic with magnetic spear lock: as soon as the spear is put in place, it is held by

two magnets mounted in a watertight chamber. This characteristic guarantees maximum speed of reset without the disadvantages of conventional mechanical restraint systems. The speargun is supplied with double 16 mm natural latex band, with Dyneema wishbone.

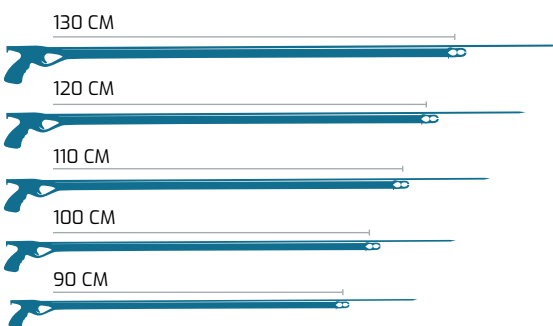

PRODUCT	CODE		RRP €
CHEROKEE POWER RUBBER GUN 90	FE365200		249,99
CHEROKEE POWER RUBBER GUN 100	FE365300		259,99
CHEROKEE POWER RUBBER GUN 110	FE365400		279,99
CHEROKEE POWER RUBBER GUN 120	FE365500		279,99
CHEROKEE POWER RUBBER GUN 130	FE365600		279,99

TECHNICAL FEATURES

- Ultra light release box and trigger
- Lateral guide line release with automatic return
- Interchangeable high-low sternal support
- Shaft \varnothing 7 mm with tig welded and drilled fins and reversed flopper
- Quick loading magnetic open muzzle
- Double circular band \varnothing 16 mm with lined wishbone 2 mm
- Rugged barrel \varnothing 28 mm with shaft guide



SHAFT \varnothing 7 MM



QUICK LOADING MAGNETIC OPEN MUZZLE



DOUBLE CIRCULAR BAND \varnothing 16 MM WITH LINED WISHBONE 2 MM



SHOCK ABSORBER



INTERCHANGEABLE HIGH-LOW SUPPORT



RUGGED AND REINFORCED BARREL WITH SHAFT GUIDE



SPECIAL HANDLE ANGLE TO INCREASE THE SHOTS' PRECISION



POWER

CHEROKEE FAST

SPECIALIZED
Retailer-Product

NOW RIGGED
Ready to Shoot

POWERFUL WITH EASY LOADING

Anticorrosive black frame with integrated spear guide, grip made of engineering plastic reinforced with glass fibre, high or low soft sternal support. Composite material release mechanism with trigger, release tooth and lateral guide line release obtained from the base. The shock absorber makes silent the release of the shaft. Reversible side safety mechanism. Reinforced reel with steel pin

buckle. Head for double elastic with magnetic spear lock: as soon as the spear is put in place, it is held by two magnets mounted in a watertight chamber. This characteristic guarantees maximum speed of reset without the disadvantages of conventional mechanical restraint systems.

TECHNICAL FEATURES

- Anticorrosive black barrel with integrated spear guide
- Handle made of engineering plastic reinforced with fiberglass
- Adjustable ergonomic handle, two screws allow you to set a larger or smaller handle
- Sideline release integrated into the body of the gun.
- Cobra design open-muzzle featuring softer angles for reducing friction with the bands
- Muzzle with the spear-lock system: two magnets keep the shaft in position
- Shock absorber for silencing the release of the shaft
- Reel included featuring a quick-release mounting bracket
- Choice between two sternal supports, one long and one short
- Supplied assembled, ready for use, with two elastic bands with nylon cord (Ø 14 mm) and a stainless steel shaft (Ø 6.5 mm)
- Measurements: 120, 110, 100, 90 and 75 cm

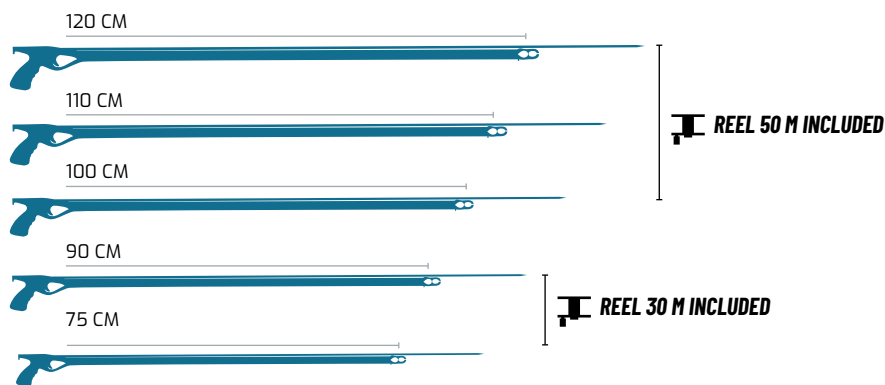

SHAFT Ø 6.5 MM



QUICK LOADING MAGNETIC OPEN MUZZLE



DOUBLE CIRCULAR BAND Ø 14 MM WITH LINED WISHBONE 2 MM



SHOCK ABSORBER

INTERCHANGEABLE HIGH-LOW SUPPORT



28 MM

RUGGED AND REINFORCED BARREL WITH SHAFT GUIDE



ULTRA LIGHT HANDLE, RELEASE BOX AND TRIGGER. LATERAL GUIDE LINE RELEASE WITH AUTOMATIC RETURN

PRODUCT	CODE		RRP €
CHEROKEE FAST RUBBER GUN 75	FE363100		229.99
CHEROKEE FAST RUBBER GUN 90	FE363200		229.99
CHEROKEE FAST RUBBER GUN 100	FE363300		259.99
CHEROKEE FAST RUBBER GUN 110	FE363400		259.99
CHEROKEE FAST RUBBER GUN 120	FE363500		259.99



CHEROKEE EXO

SPECIALIZED
Retailer-Product

NOW RIGGED
Ready to Shoot

MODULAR POWER

Anticorrosion black frame with integrated spear guide, grip made of engineering plastic reinforced with glass fibre, high or low sternal support. Ultra-light triggering case with trigger, release mechanism and line ring on the side in AISI 316, machined from solid with a CNC process. The shock absorber makes silent the release of the shaft. Reversible side-safety mechanism. Reinforced

reel with steel pin buckle. Head for double elastic with magnetic spear lock: as soon as the spear is put in place, it is held by two magnets mounted in a watertight chamber. This characteristic guarantees maximum speed of reset without the disadvantages of conventional mechanical restraint systems. The speargun is supplied with a 16 mm natural latex elastic, with Dyneema wishbone.

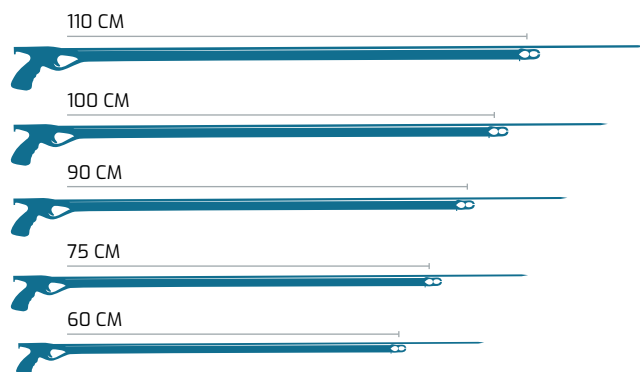

PRODUCT	CODE		RRP €
CHEROKEE EXO RUBBER GUN 60	FE364000		169,99
CHEROKEE EXO RUBBER GUN 75	FE364100		179,99
CHEROKEE EXO RUBBER GUN 90	FE364200		179,99
CHEROKEE EXO RUBBER GUN 100	FE364300		189,99
CHEROKEE EXO RUBBER GUN 110	FE364400		189,99

TECHNICAL FEATURES

- Ultra light release box and trigger
- Lateral guide line release with automatic return
- Interchangeable high-low sternal support
- Interchangeable high-low sternal support
- Shaft Ø 6.5 mm
- Quick loading magnetic open muzzle
- Circular band Ø 16 mm with lined wishbone 2 mm
- Rigged barrel Ø 28 mm with shaft guide
- Measurements: 110, 100, 90, 75 and 60 cm



SHAFT Ø 6.5 MM



QUICK LOADING MAGNETIC OPEN MUZZLE



CIRCULAR BAND Ø 16 MM WITH LINED WISHBONE 2 MM



RUGGED AND REINFORCED BARREL WITH SHAFT GUIDE INTERCHANGEABLE HIGH-LOW SUPPORT



ULTRA LIGHT HANDLE, RELEASE BOX AND TRIGGER. LATERAL GUIDE LINE RELEASE WITH AUTOMATIC RETURN



YUMA FAST



THE GUN FOR AMBUSH AND DEN

Anticorrosive black frame with integrated spear guide, grip made of engineering plastic reinforced with glass fibre, integrated soft sternal support. Ultra-light triggering case with release mechanism in AISI 316. Dovetail reel coupling. Head for double elastic with magnetic spear lock: as soon as the spear is put in place, it is held by two

magnets mounted in a watertight chamber. This characteristic guarantees maximum speed of reset without the disadvantages of conventional mechanical restraint systems. The speargun is supplied with double 14 mm natural latex band, with Dyneema wishbone.

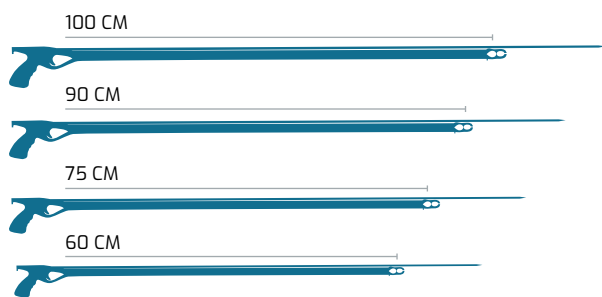

PRODUCT	CODE	RRP €
YUMA FAST GUN 60	FE349000	149,99
YUMA FAST GUN 75	FE349100	159,99
YUMA FAST GUN 90	FE349200	164,99
YUMA FAST GUN 100	FE349300	169,99

TECHNICAL FEATURES

- Guide line release with automatic return
- Integrated sternal support
- Shaft ø mm 6 with tig welded fins and reversed flopper
- Quick loading magnetic open muzzle
- Circular band ø mm 14 with lined wishbone 2 mm
- Rugged barrel ø mm 26 with shaft guide



STEEL SHAFT Ø 6 MM



QUICK LOADING MAGNETIC OPEN MUZZLE



CIRCULAR BAND Ø 14 MM



SHOCK ABSORBER

RUGGED AND REINFORCED BARREL WITH SHAFT GUIDE



SPECIAL HANDLE ANGLE TO INCREASE THE SHOT'S PRECISION



YUMA FAST

MOICANO



PERFECT FOR THE AMBUSH

Moicano is a speargun for fast fishing with its excellent handling thanks to its Ø26 mm anticorrosion aluminum barrel, with an innovative extremely rigid shaft. This combination is a great compromise between structural resilience, low production costs and ease of movement in every direction underwater. It is a very manageable, agile and multipurpose spear gun. Integrated low-friction guide as the barrel only rests on the two outer corners. The lower part is reinforced with additional thickness. This combination enables the spear gun to remain extraordinarily easy to handle while being more rigid than spear guns that are

much larger in diameter. New anatomical butt with integrated minimized load assist, derived from the legendary Apache-Comanche butt, highly resistant, reliable and appreciated by sports fishermen as a model perfect for fast fishing without problems. This proverbially ergonomic and versatile butt is suitable for every type of fishing and shooting from any position. Smooth and fast coupling of the rod and cassette mechanism, tough, reliable and compatible with all types of shafts, tolerant of different heights, finishings and machining.

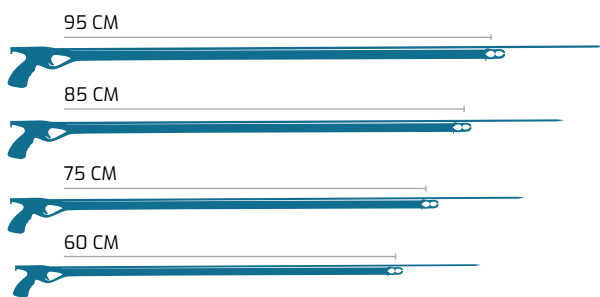

PRODUCT	CODE		RRP €
MOICANO RUBBER GUN 60	FE343060		149,99
MOICANO RUBBER GUN 75	FE343075		159,99
MOICANO RUBBER GUN 85	FE343085		169,99
MOICANO RUBBER GUN 95	FE343095		179,99

TECHNICAL FEATURES

- Camouflage brown barrel
- High quality pure latex black Standard bands Ø 18 mm
- French articulated wishbone
- Shaft in 17 4 PH (AISI 630) tempered steel Ø 6 mm
- Dark top coat
- Measurements: 60, 75, 85 and 95 cm



STEEL SHAFT Ø 6 MM



ULTRA COMPACT CLOSED MUZZLE



STANDARD BAND Ø 16 MM



RUGGED AND REINFORCED BARREL WITH SHAFT GUIDE, WITH CAMOUFLAGE TREATMENT



SPECIAL HANDLE ANGLE TO INCREASE THE SHOT'S PRECISION



COMANCHE RAIL

THE HISTORY OF OUR SPEARGUNS



Comanche's much appreciated tried and tested grip, together with an anticorrosion aluminium frame with integrated shaft guide and the new QuickLoad mini spearhead make it the most precise and practical speargun out there, particularly for charging. The reel is attached by dovetail joint. It is possible to assemble the speargun band.

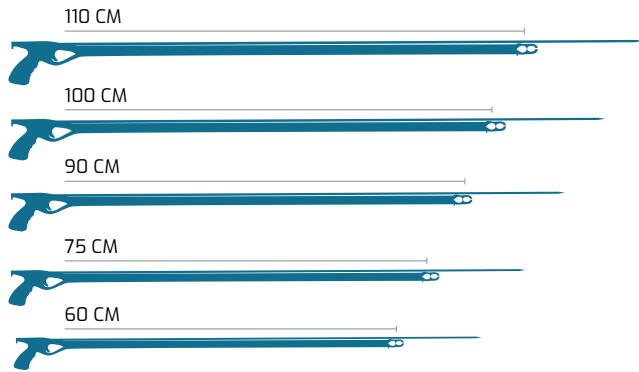

PRODUCT	CODE	RRP €
COMANCHE RAIL RUBBER GUN 60	FE359000	134,99
COMANCHE RAIL RUBBER GUN 75	FE359100	139,99
COMANCHE RAIL RUBBER GUN 90	FE359200	139,99
COMANCHE RAIL RUBBER GUN 100	FE359300	149,99
COMANCHE RAIL RUBBER GUN 110	FE359400	159,99

TECHNICAL FEATURES

- Shaft in 16-4 PH tempered steel Ø 6 mm in diameter
- Dark top coat
- Measurements: 60, 75, 90, 100, 110 cm



STEEL SHAFT Ø 6 MM



ULTRA COMPACT CLOSED MUZZLE QUICKLOAD MINI SPEARHEAD



STANDARD BAND Ø 16 MM



RUGGED BARREL WITH SHAFT GUIDE



SPECIAL HANDLE ANGLE TO INCREASE THE SHOT'S PRECISION



COMANCHE RAIL

/SLING ARBALETE

SIoux



BETTER EQUIPPED FIRST LEVEL GUN

Tried and tested and effective spear guns, the strengths of Sioux guns lie in the excellent materials used, their reliability, the easy firing and the favourable quality-price ratio. The barrel is made from light, non-deformable anti-corrodal aluminium. The inclination of the handgrip is designed for perfect firing and for quick, instinctive aiming; this is covered in rubbersoft. The trigger

system is very gentle and progressive, and is fitted with a safety catch. A strong ring for the line comes out of the bottom of the handgrip, and at the front there are 2 line releasing devices, the dovetail trigger for the reel and a somewhat advanced spear-rail saddle.



PRODUCT	CODE		RRP €
SIoux RUBBER GUN 50	FE345000		87,99
SIoux RUBBER GUN 60	FE346000		88,99
SIoux RUBBER GUN 75	FE347500		99,99

TECHNICAL FEATURES

- The muzzle has Ø 13 mm standard bands complete with simple arched wishbones with a right ratio between loading ease and forward thrust
- The muzzle is set for possible use of a second circular band
- The Ø 6 mm diameter shaft comes with a single wing and two weapon notches
- Measurements: 75, 60 and 50 cm

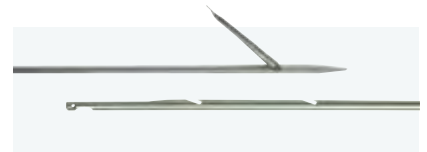

STEEL SHAFT Ø 6.5 MM



ULTRA COMPACT CLOSED MUZZLE
QUICKLOAD MINI SPEARHEAD



STANDARD BAND Ø 13 MM



BARREL MADE FROM NON-DEFORMABLE ALUMINIUM



SPECIAL HANDLE ANGLE TO INCREASE THE SHOT'S PRECISION



APACHE



ROBUST AND MINIMALIST

Simplified version of the Navajo model. Open head, robust and minimalist, to optimize the visibility of the shaft. It is a spear gun of competition range, but also adapted to non-professional underwater fishermen, for the incorporation of basic accessories. Anodised aluminium tube 26 mm in diameter.

High resistance to flexion once the rubbers have been tensioned, with the consequent increase in precision. Speargun that stands out for its perfect stability and compensation due to the distribution of weights. 6 mm diameter steel shaft.

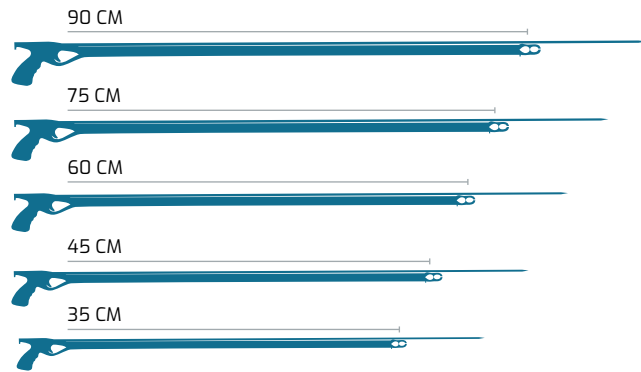

PRODUCT	CODE		RRP €
APACHE RUBBER GUN 35	FE341035		75,99
APACHE RUBBER GUN 45	FE341045		75,99
APACHE RUBBER GUN 60	FE341060		75,99
APACHE RUBBER GUN 75	FE341075		89,99
APACHE RUBBER GUN 90	FE341090		89,99

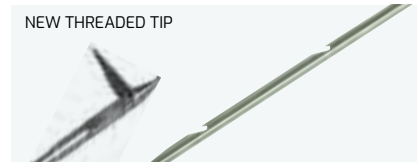

NEW THREADED TIP
SHAFT Ø 7 MM



OPEN MUZZLE



CIRCULAR BAND Ø 13 MM



BARREL Ø 26 MM



SPECIAL HANDLE ANGLE TO INCREASE THE SHOT'S PRECISION



APACHE

/ PNEUMATIC SPEARGUNS

MACH

SPECIALIZED
Retailer-Product

NOW RIGGED
Ready to Shoot

PRECISION & VERSATILITY

Cressi's Mach pneumatic speargun is a product that stands out for its exceptional performance and versatility. The excellent ratio between size and power makes it ideal for both beginner and experienced fishermen.

The offset shaft allows for easy and precise pointing, enhancing the fishing experience; furthermore, the muzzle with large outlets

is designed in such a way as to avoid energy dispersion when the shaft is released, guaranteeing greater power and shooting precision. Another innovation is the side rod release. This system simplifies reel operation and loading, allowing the angler to easily handle the rifle. The steel trigger offers great sensitivity in shooting, allowing the action to be precisely controlled.

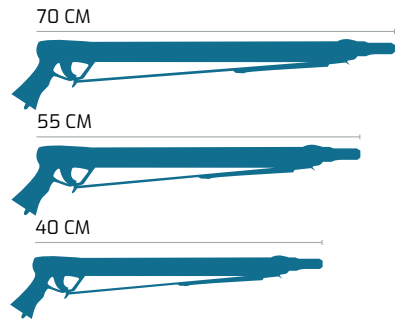
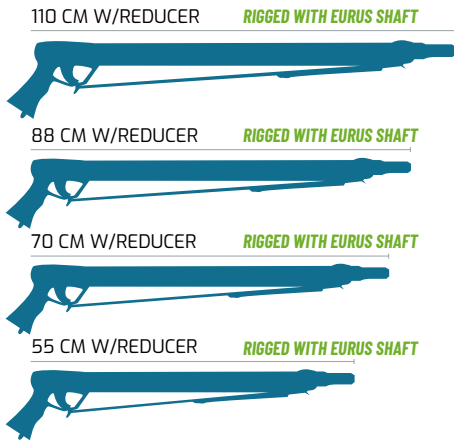

PRODUCT	CODE	RRP €
MACH PNEUMATIC GUN W/REDUCER 55	FS410055	199,99
MACH PNEUMATIC GUN W/REDUCER 70	FS410070	219,99
MACH PNEUMATIC GUN W/REDUCER 88	FS410088	249,99
MACH PNEUMATIC GUN W/REDUCER 110	FS410110	269,99

PRODUCT	CODE	RRP €
MACH PNEUMATIC GUN 40	FR410040	149,99
MACH PNEUMATIC GUN 55	FR410055	159,99
MACH PNEUMATIC GUN 70	FR410070	169,99

TECHNICAL FEATURES

- Superior performance and versatility
- Easy and accurate pointing
- Side rod release
- Simplified reel loading operation
- Upgraded muzzle with incorporated holes for water drainage
- Threaded shaft Ø 8.0 mm
- Power reducer version available
- Measurements: 80, 70, 55 and 40 cm
- Measurements with reducer: 110, 88, 70 and 55 cm

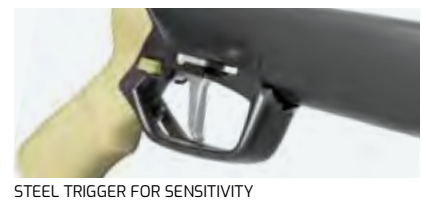

/ PNEUMATIC SPEARGUNS

SL STAR



THE HISTORY OF OUR PNEUMATIC GUNS

The SL Star range of pneumatic spear guns has been in production for many years now, and they have won worldwide fame for their excellence in terms of robustness, reliability, precision and powerful shooting. The various models correspond to the equivalent models in the SL series, without power reducer. Constantly updated over the years,

the SL Star spear guns are ultra light, easy to use, and fire quickly. They come with anatomical high grip butts enabling the gun to be held in line with the arm with no extra effort. The bright red butt means you can identify the gun even if it ends up on the sea-bottom after shooting.

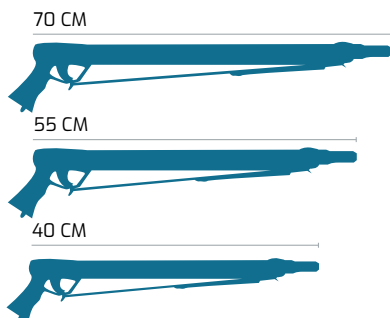
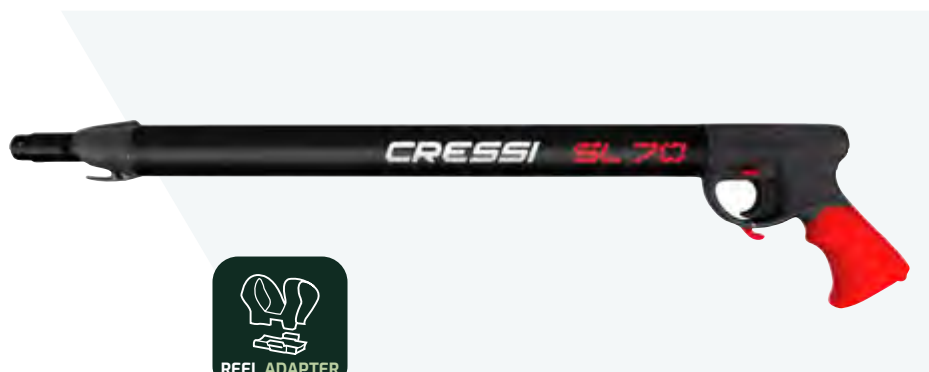

TECHNICAL FEATURES

- A strong line hook is situated on the bottom of the butt for shaft loading
- The guns are fitted with a safety catch and, when the trigger is pulled, it frees the line releasing device
- The SL Star spear guns come with an Ø 8 mm threaded steel shaft
- Measurements: 70, 55 and 40 cm



SHAFT Ø MM 8



INT. BARREL Ø 13MM



OFFSET BARREL

PRODUCT	CODE		RRP €
SL/STAR PNEUMATIC GUN 40	FR374000		144,99
SL/STAR PNEUMATIC GUN 55	FR375500		154,99
SL/STAR PNEUMATIC GUN 70	FR377000		164,99



SL STAR

/COMPARISON TABLE

		RUBBER SPEARGUN	GUN DETAILS											MATERIAL
			OVERALL LENGTH cm - in	POWER LENGTH cm - in	BARRELL Ø mm	SHOT RANGE m - ft	READY TO USE	SHOCK ABSORBER INCLUDED	MUZZLE TYPE	REEL ATTACHMENT	LINE LOOP			
	VICTORY 90	127 50 91 35.8	31	6.2 20.3	NO	YES	3X CLOSED CIRCULAR BAND	DIRECT MOUNT	2	17-4PH STAINLESS STEEL				
	VICTORY 100	137 53.9 101 39.8	31	6.9 22.6	NO	YES	3X CLOSED CIRCULAR BAND	DIRECT MOUNT	2	17-4PH STAINLESS STEEL				
	VICTORY 110	147 57.9 111 43.7	31	7.4 24.3	NO	YES	3X CLOSED CIRCULAR BAND	DIRECT MOUNT	2	17-4PH STAINLESS STEEL				
	VICTORY 120	157 61.8 121 47.6	31	7.8 25.6	NO	YES	3X CLOSED CIRCULAR BAND	DIRECT MOUNT	2	17-4PH STAINLESS STEEL				
	VICTORY 130	167 65.7 131 51.6	31	8.3 27.2	NO	YES	3X CLOSED CIRCULAR BAND	DIRECT MOUNT	2	17-4PH STAINLESS STEEL				
	VICTORY 140	177 69.7 141 55.5	31	8.8 28.9	NO	YES	3X CLOSED CIRCULAR BAND	DIRECT MOUNT	2	17-4PH STAINLESS STEEL				
	CHEROKEE POWER RUBBER GUN 100	138 54.3 104 40.9	28	6.9 22.7	NO	YES	2X CIRCULAR BAND	DOVETAIL	2	17-4 PH STAINLESS STEEL				
	CHEROKEE POWER RUBBER GUN 110	148 58.2 114 44.8	28	7.4 24.3	NO	YES	2X CIRCULAR BAND	DOVETAIL	2	17-4 PH STAINLESS STEEL				
	CHEROKEE POWER RUBBER GUN 120	158 62.2 124 48.8	28	7.8 25.8	NO	YES	2X CIRCULAR BAND	DOVETAIL	2	17-4 PH STAINLESS STEEL				
	CHEROKEE POWER RUBBER GUN 130	168 66.1 134 52.7	28	8.3 27.4	NO	YES	2X CIRCULAR BAND	DOVETAIL	2	17-4 PH STAINLESS STEEL				
	CHEROKEE FAST RUBBER GUN 75	113 44.4 79 31.1	28	5.5 18.1	NO	YES	2X CIRCULAR BAND	DOVETAIL	1	17-4 PH STAINLESS STEEL				
	CHEROKEE FAST RUBBER GUN 90	128 50.3 94 37.0	28	6.2 20.3	NO	YES	2X CIRCULAR BAND	DOVETAIL	1	17-4 PH STAINLESS STEEL				
	CHEROKEE FAST RUBBER GUN 100	138 54.3 104 40.9	28	6.6 21.8	NO	YES	2X CIRCULAR BAND	DOVETAIL	1	17-4 PH STAINLESS STEEL				
	CHEROKEE FAST RUBBER GUN 110	148 58.2 114 44.8	28	7.1 23.3	NO	YES	2X CIRCULAR BAND	DOVETAIL	1	17-4 PH STAINLESS STEEL				
	CHEROKEE FAST RUBBER GUN 120	158 62.2 124 48.8	28	7.5 24.9	NO	YES	2X CIRCULAR BAND	DOVETAIL	1	17-4 PH STAINLESS STEEL				
	CHEROKEE EXO RUBBER GUN 60	98 38.5 64 25.1	28	4.5 14.9	NO	YES	2X CIRCULAR BAND	DOVETAIL	1	17-4 PH STAINLESS STEEL				
	CHEROKEE EXO RUBBER GUN 75	113 44.4 79 31.1	28	5.2 17.0	NO	YES	2X CIRCULAR BAND	DOVETAIL	1	17-4 PH STAINLESS STEEL				
	CHEROKEE EXO RUBBER GUN 90	128 50.3 94 37.0	28	5.8 19.1	NO	YES	2X CIRCULAR BAND	DOVETAIL	1	17-4 PH STAINLESS STEEL				
	CHEROKEE EXO RUBBER GUN 100	138 54.3 104 40.9	28	6.2 20.6	NO	YES	2X CIRCULAR BAND	DOVETAIL	1	17-4 PH STAINLESS STEEL				
	CHEROKEE EXO RUBBER GUN 110	148 58.2 114 44.8	28	6.7 22.0	NO	YES	2X CIRCULAR BAND	DOVETAIL	1	17-4 PH STAINLESS STEEL				
	COMANCHE RAIL RUBBER GUN 60	102 40.1 60 23.6	28	4.3 14.1	YES	NO	1X PARALLEL + 1X CIRCULAR BAND	DOVETAIL	1	17-4 PH STAINLESS STEEL				
	COMANCHE RAIL RUBBER GUN 75	127 50.0 75 29.5	28	5.3 17.4	YES	NO	1X PARALLEL + 1X CIRCULAR BAND	DOVETAIL	1	17-4 PH STAINLESS STEEL				
	COMANCHE RAIL RUBBER GUN 90	142 55.9 90 35.4	28	5.9 19.4	YES	NO	1X PARALLEL + 1X CIRCULAR BAND	DOVETAIL	1	17-4 PH STAINLESS STEEL				
	COMANCHE RAIL RUBBER GUN 100	152 59.8 100 39.3	28	6.3 20.7	YES	NO	1X PARALLEL + 1X CIRCULAR BAND	DOVETAIL	1	17-4 PH STAINLESS STEEL				
	COMANCHE RAIL RUBBER GUN 110	162 63.7 110 43.3	28	6.7 22.0	YES	NO	1X PARALLEL + 1X CIRCULAR BAND	DOVETAIL	1	17-4 PH STAINLESS STEEL				
	MOICANO RUBBER GUN 60	102 40.1 58 22.8	26	4.3 14.1	YES	NO	1X PARALLEL + 1X CIRCULAR BAND	DOVETAIL	1	17-4 PH STAINLESS STEEL				
	MOICANO RUBBER GUN 75	117 46.0 73 28.7	26	4.9 16.1	YES	NO	1X PARALLEL + 1X CIRCULAR BAND	DOVETAIL	1	17-4 PH STAINLESS STEEL				
	MOICANO RUBBER GUN 85	127 50.0 83 32.6	26	5.3 17.4	YES	NO	1X PARALLEL + 1X CIRCULAR BAND	DOVETAIL	1	17-4 PH STAINLESS STEEL				
	MOICANO RUBBER GUN 95	137 53.9 93 36.6	26	5.7 18.7	YES	NO	1X PARALLEL + 1X CIRCULAR BAND	DOVETAIL	1	17-4 PH STAINLESS STEEL				
		YUMA FAST GUN 60	102 40.1 64 25.1	26	4.3 14.1	NO	YES	2X CIRCULAR BAND	DOVETAIL	1	17-4 PH STAINLESS STEEL			
YUMA FAST GUN 75		117 46.0 79 31.1	26	4.9 16.1	NO	YES	2X CIRCULAR BAND	DOVETAIL	1	17-4 PH STAINLESS STEEL				
YUMA FAST GUN 90		132 51.9 94 37.0	26	5.5 18.1	NO	YES	2X CIRCULAR BAND	DOVETAIL	1	17-4 PH STAINLESS STEEL				
YUMA FAST GUN 100		142 55.9 104 40.9	26	5.9 19.4	NO	YES	2X CIRCULAR BAND	DOVETAIL	1	17-4 PH STAINLESS STEEL				
SIoux RUBBER GUN 50		87 34.2 50 19.6	28	3.4 11.4	NO	NO	1X PARALLEL + 1X CIRCULAR BAND	DOVETAIL	1	PR80 GALVANIZED SPRING				
SIoux RUBBER GUN 60		102 40.1 60 23.6	28	4.0 13.2	NO	NO	1X PARALLEL + 1X CIRCULAR BAND	DOVETAIL	1	PR80 GALVANIZED SPRING				
	SIoux RUBBER GUN 75	117 46.0 75 29.5	28	4.6 15.1	NO	NO	1X PARALLEL + 1X CIRCULAR BAND	DOVETAIL	1	PR80 GALVANIZED SPRING				
	APACHE RUBBER GUN 35	67 26.3 30 11.8	26	3.0 10.1	NO	NO	1X CIRCULAR BAND	NO	1	PR80 GALVANIZED SPRING				
	APACHE RUBBER GUN 45	77 30.3 40 15.7	26	3.4 11.3	NO	NO	1X CIRCULAR BAND	NO	1	PR80 GALVANIZED SPRING				
	APACHE RUBBER GUN 60	87 34.2 55 21.6	26	3.8 12.6	NO	NO	1X CIRCULAR BAND	NO	1	PR80 GALVANIZED SPRING				
	APACHE RUBBER GUN 75	102 40.1 70 27.5	26	4.4 14.5	NO	NO	1X CIRCULAR BAND	NO	1	PR80 GALVANIZED SPRING				
	APACHE RUBBER GUN 90	117 46.0 85 33.4	26	4.9 16.3	NO	NO	1X CIRCULAR BAND	NO	1	PR80 GALVANIZED SPRING				

		PNEUMATIC SPEARGUN	GUN DETAILS							
			READY TO USE SET	SHOCK ABSORBER INCLUDED	SHOT RANGE m - ft	TOTAL LENGTH GUN + SPEAR cm	REEL ATTACHMENT	BARREL DIAMETER mm	LINE LOOP	
	MACH PNEUMATIC GUN W/REDUCER 55	NO	NO	3.0 9.8	85	REEL ADAPTER	13	2		
	MACH PNEUMATIC GUN W/REDUCER 70	NO	NO	3.4 11.4	100	REEL ADAPTER	13	2		
	MACH PNEUMATIC GUN W/REDUCER 88	NO	NO	4.1 13.5	118	REEL ADAPTER	13	2		
	MACH PNEUMATIC GUN W/REDUCER 110	NO	NO	4.8 15.9	140	REEL ADAPTER	13	2		
	MACH PNEUMATIC GUN 40	NO	NO	2.4 7.9	70	REEL ADAPTER	13	2		
	MACH PNEUMATIC GUN 55	NO	NO	3.0 9.8	85	REEL ADAPTER	13	2		
	MACH PNEUMATIC GUN 70	NO	NO	3.4 11.4	100	REEL ADAPTER	13	2		
	SL/STAR PNEUMATIC GUN 40	NO	NO	2.2 7.3	70	REEL ADAPTER	13	2		
	SL/STAR PNEUMATIC GUN 55	NO	NO	2.7 9.0	85	REEL ADAPTER	13	2		
	SL/STAR PNEUMATIC GUN 70	NO	NO	3.1 10.4	100	REEL ADAPTER	13	2		

SHAFT DETAILS											POWER BAND DETAILS				
Ø mm	LENGTH cm	FLOPPER TYPE	TAB N°	TAB TYPE	REST TAB	POINT TYPE	COMPATIBLE SHAFTS Ø RANGE mm	COMPATIBLE SHAFTS LENGTHS RANGE cm	INCLUDED SHAFT SKU	N°	TYPE	MATERIAL	Ø mm	LENGTH cm	WISHBONE
7.5	120	BOTTOM	3	LARGE SHARKFIN	YES	TRI-CUT	FROM 6.5 TO 7.5	120/130	FA421702	3X	CIRCULAR	DIPPED NATURAL RUBBER LATEX	14	57	DYNEEMA SK78
7.5	130	BOTTOM	3	LARGE SHARKFIN	YES	TRI-CUT	FROM 6.5 TO 7.5	130/140	FA421703	3X	CIRCULAR	DIPPED NATURAL RUBBER LATEX	14	63	DYNEEMA SK78
7.5	140	BOTTOM	3	LARGE SHARKFIN	YES	TRI-CUT	FROM 6.5 TO 7.5	140/150	FA421704	3X	CIRCULAR	DIPPED NATURAL RUBBER LATEX	14	69	DYNEEMA SK78
7.5	150	BOTTOM	3	LARGE SHARKFIN	YES	TRI-CUT	FROM 6.5 TO 7.5	150/160	FA421705	3X	CIRCULAR	DIPPED NATURAL RUBBER LATEX	14	76	DYNEEMA SK78
7.5	160	BOTTOM	3	LARGE SHARKFIN	YES	TRI-CUT	FROM 6.5 TO 7.5	160/170	FA421706	3X	CIRCULAR	DIPPED NATURAL RUBBER LATEX	14	82	DYNEEMA SK78
7.5	170	BOTTOM	3	LARGE SHARKFIN	YES	TRI-CUT	FROM 6.5 TO 7.5	170/180	FA421707	3X	CIRCULAR	DIPPED NATURAL RUBBER LATEX	14	88	DYNEEMA SK78
7	130	BOTTOM	2	LARGE SHARKFIN	YES	PIN POINT	FROM 6 TO 7	130/145	FA404905	2X	CIRCULAR	DIPPED NATURAL RUBBER LATEX	16	63	DYNEEMA® SK78
7	140	BOTTOM	2	LARGE SHARKFIN	YES	PIN POINT	FROM 6 TO 7	140/155	FA404906	2X	CIRCULAR	DIPPED NATURAL RUBBER LATEX	16	69.5	DYNEEMA® SK78
7	150	BOTTOM	2	LARGE SHARKFIN	YES	PIN POINT	FROM 6 TO 7	150/165	FA404907	2X	CIRCULAR	DIPPED NATURAL RUBBER LATEX	16	77	DYNEEMA® SK78
7	160	BOTTOM	2	LARGE SHARKFIN	YES	PIN POINT	FROM 6 TO 7	160/175	-	2X	CIRCULAR	DIPPED NATURAL RUBBER LATEX	16	83	DYNEEMA® SK78
6.5	105	BOTTOM	2	MINI SHARKFIN	NO	PIN POINT	FROM 6 TO 7	105/120	FA404903	2X	CIRCULAR	DIPPED NATURAL RUBBER LATEX	14	48	DYNEEMA® SK78
6.5	120	BOTTOM	2	MINI SHARKFIN	YES	PIN POINT	FROM 6 TO 7	120/135	FA404904	2X	CIRCULAR	DIPPED NATURAL RUBBER LATEX	14	57	DYNEEMA® SK78
6.5	130	BOTTOM	2	MINI SHARKFIN	YES	PIN POINT	FROM 6 TO 7	130/145	FA404905	2X	CIRCULAR	DIPPED NATURAL RUBBER LATEX	14	63	DYNEEMA® SK78
6.5	140	BOTTOM	2	MINI SHARKFIN	YES	PIN POINT	FROM 6 TO 7	140/155	FA404906	2X	CIRCULAR	DIPPED NATURAL RUBBER LATEX	14	69.5	DYNEEMA® SK78
6.5	150	BOTTOM	2	MINI SHARKFIN	YES	PIN POINT	FROM 6 TO 7	150/165	FA404907	2X	CIRCULAR	DIPPED NATURAL RUBBER LATEX	14	77	DYNEEMA® SK78
6.5	90	BOTTOM	2	MINI SHARKFIN	NO	PIN POINT	FROM 6 TO 7	90/105	FA404902	1X	CIRCULAR	DIPPED NATURAL RUBBER LATEX	16	39	DYNEEMA® SK78
6.5	105	BOTTOM	2	MINI SHARKFIN	NO	PIN POINT	FROM 6 TO 7	105/120	FA404903	1X	CIRCULAR	DIPPED NATURAL RUBBER LATEX	16	48	DYNEEMA® SK78
6.5	120	BOTTOM	2	MINI SHARKFIN	YES	PIN POINT	FROM 6 TO 7	120/135	FA404904	1X	CIRCULAR	DIPPED NATURAL RUBBER LATEX	16	57	DYNEEMA® SK78
6.5	130	BOTTOM	2	MINI SHARKFIN	YES	PIN POINT	FROM 6 TO 7	130/145	FA404905	1X	CIRCULAR	DIPPED NATURAL RUBBER LATEX	16	63	DYNEEMA® SK78
6.5	140	BOTTOM	2	MINI SHARKFIN	YES	PIN POINT	FROM 6 TO 7	140/155	FA404906	1X	CIRCULAR	DIPPED NATURAL RUBBER LATEX	16	69.5	DYNEEMA® SK78
6	90	TOP	2	SMOOTH NOTCH	NO	PIN POINT	FROM 6 TO 7	90-105	FA410002	1X	PARALLEL	SYNTHETIC	16	16	JOINTED-WISHBONE
6	115	TOP	2	SMOOTH NOTCH	NO	PIN POINT	FROM 6 TO 7	105-120	FA410004	1X	PARALLEL	SYNTHETIC	16	18.5	JOINTED-WISHBONE
6	130	TOP	2	SMOOTH NOTCH	YES	PIN POINT	FROM 6 TO 7	120-135	FA410006	1X	PARALLEL	SYNTHETIC	16	22	JOINTED-WISHBONE
6	140	TOP	2	SMOOTH NOTCH	YES	PIN POINT	FROM 6 TO 7	130-145	FA410007	1X	PARALLEL	SYNTHETIC	16	25.5	JOINTED-WISHBONE
6	150	TOP	2	SMOOTH NOTCH	YES	PIN POINT	FROM 6 TO 7	140-155	FA410008	1X	PARALLEL	SYNTHETIC	16	27.5	JOINTED-WISHBONE
6	90	TOP	2	SMOOTH NOTCH	NO	PIN POINT	UP TO 6	90-95	FA410002	1X	PARALLEL	SYNTHETIC	16	16	JOINTED-WISHBONE
6	105	TOP	2	SMOOTH NOTCH	NO	PIN POINT	UP TO 6	105-110	FA410003	1X	PARALLEL	SYNTHETIC	16	18.5	JOINTED-WISHBONE
6	115	TOP	2	SMOOTH NOTCH	NO	PIN POINT	UP TO 6	115-120	FA410004	1X	PARALLEL	SYNTHETIC	16	20	JOINTED-WISHBONE
6	125	TOP	2	SMOOTH NOTCH	YES	PIN POINT	UP TO 6	125-130	FA410005	1X	PARALLEL	SYNTHETIC	16	22	JOINTED-WISHBONE
6	90	BOTTOM	2	MINI SHARKFIN	NO	PIN POINT	UP TO 6	90-95	FA410002	1X	CIRCULAR	DIPPED NATURAL RUBBER LATEX	14	39	DYNEEMA® SK78
6	105	BOTTOM	2	MINI SHARKFIN	NO	PIN POINT	UP TO 6	105-110	FA410003	1X	CIRCULAR	DIPPED NATURAL RUBBER LATEX	14	48	DYNEEMA® SK78
6	120	BOTTOM	2	MINI SHARKFIN	YES	PIN POINT	UP TO 6	120-125	FA410004	1X	CIRCULAR	DIPPED NATURAL RUBBER LATEX	14	57	DYNEEMA® SK78
6	130	BOTTOM	2	MINI SHARKFIN	YES	PIN POINT	UP TO 6	130-135	FA410005	1X	CIRCULAR	DIPPED NATURAL RUBBER LATEX	14	63	DYNEEMA® SK78
6.5	75	TOP	2	SHARP NOTCH	NO	PIN POINT	FROM 6 TO 7	75-85	FA340001	1X	PARALLEL	SYNTHETIC	13	13	STANDARD-WISHBONE
6.5	90	TOP	2	SHARP NOTCH	NO	PIN POINT	FROM 6 TO 7	90-100	FA340002	1X	PARALLEL	SYNTHETIC	13	17	STANDARD-WISHBONE
6.5	105	TOP	2	SHARP NOTCH	NO	PIN POINT	FROM 6 TO 7	105-110	FA340003	1X	PARALLEL	SYNTHETIC	13	24	STANDARD-WISHBONE
7	65	THREAD SPEAR	2	SHARP NOTCH	NO	PIN POINT	FROM 6 TO 7	-	FA350535	1X	CIRCULAR	SYNTHETIC	13	24	STANDARD-WISHBONE
7	75	THREAD SPEAR	2	SHARP NOTCH	NO	PIN POINT	FROM 6 TO 7	-	FA350545	1X	CIRCULAR	SYNTHETIC	13	31	STANDARD-WISHBONE
7	85	THREAD SPEAR	2	SHARP NOTCH	NO	PIN POINT	FROM 6 TO 7	-	FA350560	1X	CIRCULAR	SYNTHETIC	13	34	STANDARD-WISHBONE
7	100	THREAD SPEAR	2	SHARP NOTCH	NO	PIN POINT	FROM 6 TO 7	-	FA350575	1X	CIRCULAR	SYNTHETIC	13	39	STANDARD-WISHBONE
7	115	THREAD SPEAR	2	SHARP NOTCH	NO	PIN POINT	FROM 6 TO 7	-	FA350590	1X	CIRCULAR	SYNTHETIC	13	44	STANDARD-WISHBONE

EASIER LOADING PRESSURE		STANDARD PRESSURE		HARDER LOADING PRESSURE		SHAFT DETAILS					
BAR	PSI	BAR	PSI	BAR	PSI	MATERIAL	DIAMETER mm	LENGTH cm	FLOPPER TYPE	POINT TYPE	INCLUDED SHAFT SKU
16	232	18	261	24	348	17-4PH STAINLESS STEEL	7.5	64.0	THREADED-DOUBLE FLOPPER	PIN POINT	FA380701
16	232	18	261	24	348	17-4PH STAINLESS STEEL	7.5	79.0	THREADED-DOUBLE FLOPPER	PIN POINT	FA380702
16	232	18	261	24	348	17-4PH STAINLESS STEEL	7.5	97.0	SINGLE FLOPPER	PIN POINT	FA380703
16	232	18	261	24	348	17-4PH STAINLESS STEEL	7.5	119.0	SINGLE FLOPPER	PIN POINT	FA380704
16	232	18	261	24	348	PR80 GALVANIZED SPRING	8.0	36.5 (+10)	THREAD SPEAR FLOPPER	PIN POINT	FA372801
16	232	18	261	24	348	PR80 GALVANIZED SPRING	8.0	55.0 (+10)	THREAD SPEAR FLOPPER	PIN POINT	FA372802
16	232	18	261	24	348	PR80 GALVANIZED SPRING	8.0	68.5 (+10)	THREAD SPEAR FLOPPER	PIN POINT	FA372803
16	232	18	261	24	348	PR80 GALVANIZED SPRING	8.0	36.5 (+10)	THREAD SPEAR FLOPPER	PIN POINT	FA360036
16	232	18	261	24	348	PR80 GALVANIZED SPRING	8.0	55.0 (+10)	THREAD SPEAR FLOPPER	PIN POINT	FA361036
16	232	18	261	24	348	PR80 GALVANIZED SPRING	8.0	68.5 (+10)	THREAD SPEAR FLOPPER	PIN POINT	FA362036

MUZZLE FOR 28MM BARRELL

Glass-filled nylon muzzle and stainless steel slide line suitable for double circular rubber band - Ø 18mm max.



PRODUCT	SIZE	CODE		RRP €
DOUBLE CIRCULAR BAND MUZZLE - CHEROKEE	28mm	FA357280		18,99

MUZZLE FOR 26MM BARRELL

Glass-filled nylon muzzle and stainless steel slide line suitable for double circular rubber band - Ø 18mm max.



PRODUCT	SIZE	CODE		RRP €
DOUBLE CIRCULAR BAND MUZZLE	26mm	FA357260		15,99

MUZZLE FOR 28MM AND 26MM BARRELL

Glass-filled nylon muzzle and stainless steel slide line suitable for double standard rubber band - Ø 18mm max.



PRODUCT	SIZE	CODE		RRP €
PARALLEL ELASTIC BAND MUZZLE - COMANCHE	28mm	FA357281		14,99
PARALLEL ELASTIC BAND MUZZLE - MOICANO	26mm	FA357261		13,99





Photo by: Jason Arnold

COMPLETE HANDLE FOR 26MM BARRELL

Nylon muzzle complete with TPE grip, advanced standard release mechanism and underbody line release



PRODUCT	SIZE	CODE		RRP €
STANDARD RELEASE HANDLE	26cm	FA356260		29,99

COMPLETE HANDLE FOR 28MM BARRELL

Nylon muzzle complete with TPE grip, advanced standard release mechanism and underbody line release



PRODUCT	SIZE	CODE		RRP €
STANDARD RELEASE HANDLE	28cm	FA356280		33,99

COMPLETE HANDLE FOR 28MM BARRELL

Glass-filled nylon muzzle with TPE grip, reversible side release, metal recoil release mechanism and TPE double sternal support.



PRODUCT	SIZE	CODE		RRP €
BACK RELEASE HANDLE	28cm	FA356281		45,99

/ RUBBER BANDS

S45 PLUS CIRCULAR

18 MM DIAMETER

Extruded synthetic rubber band 45 Sh/A



CODE	GUN	SIZE	MM	RRP €
FA400103	75	45cm	18	39,99
FA400104	85-90	50cm	18	39,99
FA400105	95-100	55cm	18	39,99
FA400106	105-110	62cm	18	39,99
FA400107	115-120	70cm	18	39,99

S45 PLUS CIRCULAR LW

18 MM DIAMETER WITH LINED WISHBONE

Extruded synthetic rubber band 45 Sh/A



CODE	GUN	SIZE	MM	RRP €
FA400113	75	48cm	18	42,99
FA400114	85-90	57cm	18	42,99
FA400115	95-100	63cm	18	42,99
FA400116	105-110	69.5cm	18	42,99

S30 CIRCULAR

13 MM DIAMETER

Extruded synthetic rubber band 30 Sh/A



CODE	GUN	SIZE	MM	RRP €
FA340019	35	24cm	13	18,50
FA340020	50	31cm	13	18,50
FA340021	60	34cm	13	18,50
FA340022	75	39cm	13	18,50
FA340023	90	44cm	13	18,50

S45 PLUS PAIR

18 MM DIAMETER

Extruded synthetic rubber band 45 Sh/A



CODE	GUN	SIZE	MM	RRP €
FA400021	45-50	14cm	18	36,99
FA400022	55-60	16cm	18	36,99
FA400023	75	18.5cm	18	36,99
FA400025	85-90	22cm	18	36,99
FA400026	95-100	25.5cm	18	36,99
FA400027	105-110	27.5cm	18	36,99

S40 PAIR

16 MM DIAMETER

Extruded synthetic rubber band 40 Sh/A



CODE	GUN	SIZE	MM	RRP €
FA400002	55-60	16cm	16	26,99
FA400003	75	18.5cm	16	26,99
FA400004	82-84	20cm	16	27,99
FA400005	85-90	22cm	16	27,99
FA400006	95-100	25.5cm	16	27,99
FA400007	105-110	27.5cm	16	27,99

S30 PAIR

13 MM DIAMETER

Extruded synthetic rubber band 40 Sh/A

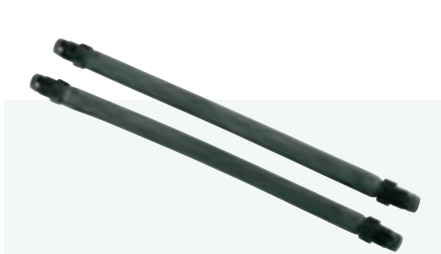

CODE	GUN	SIZE	MM	RRP €
FA340006	50	13cm	13	18,50
FA340007	60	17cm	13	18,50
FA340008	75	24cm	13	18,50

BLACK DEEPSHOT



15 MM DIAMETER
ID 2.5MM

Extruded natural latex band 45 Sh/A, reduced inner diameter. Silicone-treated band supplied in a single roll of 3mt or 15mt

NEW 2025

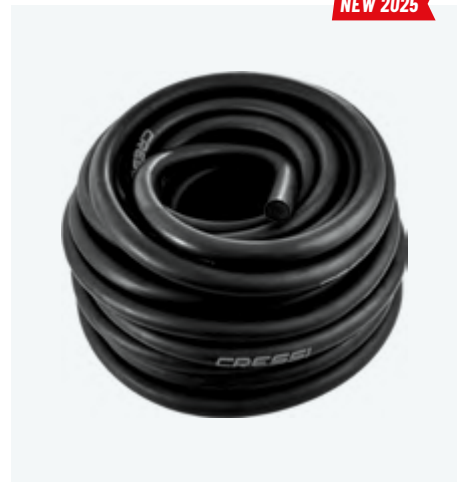

CODE	SIZE	MM	RRP €
FBO41550	3 mt	15	-
FBI55550	15mt	15	-

PURE CIRCULAR BLACK

16 MM DIAMETER
ID 3.2MM

NEW 2025



CODE	GUN	SIZE	MM	RRP €
FA400552	60	39cm	16	29,99
FA400553	75	48cm	16	29,99
FA400554	90	57cm	16	31,99
FA400555	100	63cm	16	31,99
FA400556	110	69cm	16	31,99
FA400557	120	77cm	16	31,99
FA400558	130	81cm	16	31,99

/ RUBBER BANDS

PURE CIRCULAR BLUE

16 MM DIAMETER
ID 3.2MM



CODE	GUN	SIZE	MM		RRP €
FA400524	90	57cm	16		31,99
FA400525	100	63cm	16		31,99
FA400526	110	69cm	16		31,99
FA400527	120	77cm	16		31,99
FA400528	130	81cm	16		31,99

PURE CIRCULAR LIME

16 MM DIAMETER
ID 3.2MM



CODE	GUN	SIZE	MM		RRP €
FA400562	60	39cm	16		31,99
FA400563	75	48cm	16		31,99
FA400564	90	57cm	16		31,99
FA400565	100	63cm	16		31,99
FA400566	110	69cm	16		31,99

PURE CIRCULAR RED

14 MM DIAMETER
ID 3.2MM



CODE	GUN	SIZE	MM		RRP €
FA400582	60	39cm	14		29,99
FA400583	75	48cm	14		29,99
FA400584	90	57cm	14		29,99
FA400585	100	63cm	14		29,99
FA400586	110	69cm	14		29,99
FA400587	120	77cm	14		29,99

PURE BLUE

16 MM DIAMETER
ID 3.2MM

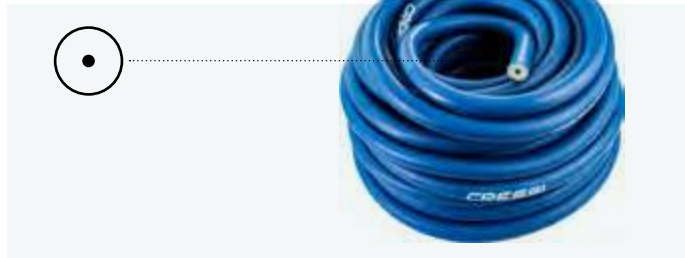

CODE	SIZE	MM	DLR €	10%	SEASONAL ORDER 20%	RRP €
FB031620	3 mt	16mm	46,88	42,19	37,50	74,99
FB154620	15mt	16mm	149,99	134,99	119,99	-

PURE GREEN

16 MM DIAMETER
ID 3.2MM



CODE	SIZE	MM		RRP €
FB031690	3 mt	16mm		74,99
FB154690	15mt	16mm		-

PURE RED

14 MM DIAMETER
ID 3.2MM



CODE	SIZE	MM		RRP €
FB031480	3 mt	14mm		70,99
FB154480	15mt	14mm		-

PURE BLACK

14 MM DIAMETER
ID 3.2MM

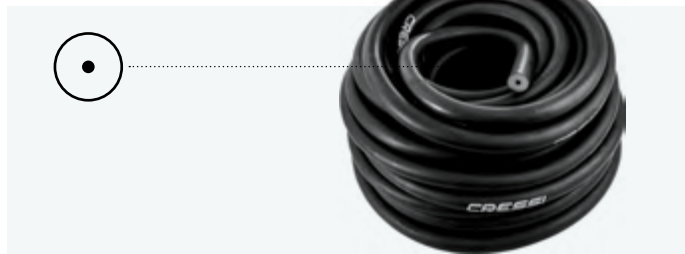

CODE	SIZE	MM		RRP €
FB031450	3 mt	14mm		70,99
FB154450	15mt	14mm		-

HYDRA

SLING GUN SHAFT: 17-4 PH FINNED BOTTOM FLOP

17-4PH steel rod with 3+1 fins, machined from solid CNC and laser welded. Bottom-mounted 1.2mm fin with a welded pin; tricuspid point.

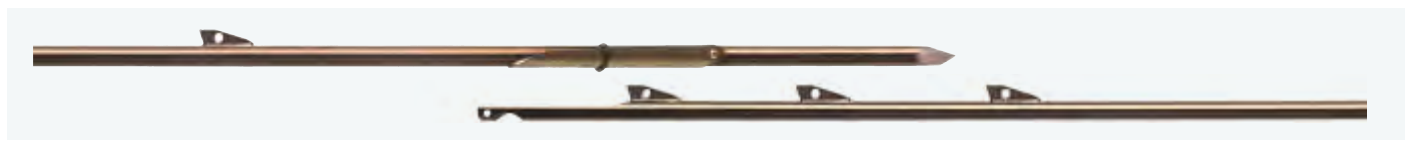

PRODUCT	CODE	SIZE	Ø		RRP €
HYDRA SHAFT BOTTOM FLOP	FA421702	120 cm	7.5 mm		69,99
HYDRA SHAFT BOTTOM FLOP	FA421703	130 cm	7.5 mm		69,99
HYDRA SHAFT BOTTOM FLOP	FA421704	140 cm	7.5 mm		69,99
HYDRA SHAFT BOTTOM FLOP	FA421705	150 cm	7.5 mm		69,99
HYDRA SHAFT BOTTOM FLOP	FA421706	160 cm	7.5 mm		69,99
HYDRA SHAFT BOTTOM FLOP	FA421707	170 cm	7.5 mm		69,99
HYDRA SHAFT BOTTOM FLOP	FA421708	180 cm	7.5 mm		69,99

KRAKEN

SLING GUN SHAFT: 17-4 PH FINNED BOTTOM FLOP

17-4PH steel rod with 2 fins, machined from solid CNC and laser welded. Bottom-mounted 1.2mm fin with a welded pin; tricuspid point.



CODE	SIZE	Ø		RRP €
FA406120	120 cm	7 mm		65,99
FA406130	130 cm	7 mm		65,99
FA406140	140 cm	7 mm		65,99
FA406150	150 cm	7 mm		65,99
FA406160	160 cm	7 mm		65,99
FA407090	90 cm	6 mm		56,99
FA407105	105 cm	6 mm		56,99
FA407120	120 cm	6 mm		56,99
FA407130	130 cm	6 mm		56,99

CODE	SIZE	Ø		RRP €
FA404902	90 cm	6.5 mm		57,99
FA404903	105 cm	6.5 mm		57,99
FA404904	120 cm	6.5 mm		57,99
FA404905	130 cm	6.5 mm		57,99
FA404906	140 cm	6.5 mm		57,99
FA404907	150 cm	6.5 mm		57,99

BARRACUDA

SLING GUN SHAFT: 17-4 PH NOTCHED TOP FLOP

17-4PH steel rod with coupling notches, machined from solid CNC and laser welded. 0.8 mm lower fin with a welded pin; tricuspid point.



CODE	SIZE	Ø		RRP €
FA410002	90 cm	6 mm		37,99
FA410003	105 cm	6 mm		37,99
FA410004	115 cm	6 mm		37,99
FA410005	125 cm	6 mm		37,99
FA410006	130 cm	6 mm		37,99
FA410007	140 cm	6 mm		37,99
FA410008	150 cm	6 mm		37,99

CODE	SIZE	Ø		RRP €
FA410502	90 cm	6.5 mm		40,99
FA410503	105 cm	6.5 mm		40,99
FA410504	115 cm	6.5 mm		40,99
FA410505	125 cm	6.5 mm		40,99
FA410506	130 cm	6.5 mm		40,99
FA410507	140 cm	6.5 mm		40,99
FA410508	150 cm	6.5 mm		40,99

/ GUN SHAFTS

VERDESCA

SLING GUN SHAFT: PR80 NOTCHED TOP FLOP



CODE	SIZE	Ø	RRP €
FA340000	65 cm	6.5 mm	15,50
FA340001	75 cm	6.5 mm	15,50
FA340002	90 cm	6.5 mm	15,50
FA340003	105 cm	6.5 mm	15,50

SLING GUN SHAFT: PR80 NOTCHED THREADED



CODE	SIZE	Ø	RRP €
FA350535	60 cm	7 mm	11,99
FA350545	70 cm	7 mm	11,99
FA350560	80 cm	7 mm	11,99
FA350575	95 cm	7 mm	11,99
FA350590	105 cm	7 mm	11,99

EURUS NEW 2025

MACH GUN SHAFT: 17-4 PH TOP FLOP OR THREADED

Pneumatic guns 17-4PH shaft with washer and line slider, large tail for new pneumatic gun.

Single Flopper or Threaded with double flopper harpon.



PRODUCT	CODE	SIZE	RRP €
THREADED-DOUBLE FLOPPER	FA380701	49 cm	39,99
THREADED-DOUBLE FLOPPER	FA380702	64 cm	39,99
SINGLE FLOPPER	FA380703	79 cm	39,99
SINGLE FLOPPER	FA380704	97 cm	39,99
SINGLE FLOPPER	FA380705	119 cm	39,99

MAESTRALE

PNEUMATIC GUN SHAFT: PR80 THREADED

For Cressi pneumatic spearguns, threaded to fit any Cressi threaded spear tip. Small shaft tail like in SL

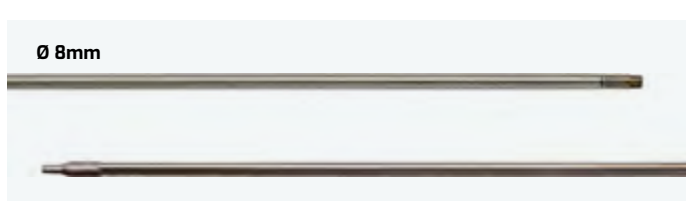

CODE	SIZE	RRP €
FA372801	36.5 cm	16,99
FA372802	55 cm	16,99
FA372803	68.5 cm	16,99
FA372804	87.5 cm	16,99
FA372806	109.5 cm	16,99

LIBECCIO

PNEUMATIC GUN SHAFT: PR80 THREADED

For Cressi pneumatic spearguns, threaded to fit any Cressi threaded spear tip. Large shaft tail like in MACH



CODE	SIZE	RRP €
FA360036	36.5 cm	15,50
FA361036	55 cm	15,50
FA362036	68.5 cm	15,50
FA363036	87.5 cm	15,50
FA365036	99.5 cm	15,50
FA366036	109.5 cm	15,50

SCIROCCO

PNEUMATIC GUN SHAFT: INOX THREADED

Tempered steel shaft for Cressi pneumatic spearguns. Threaded to fit any Cressi threaded spear tip. Small shaft tail like in SL



CODE	SIZE	RRP €
FA360030	36.5 cm	17,99
FA360031	55 cm	17,99
FA360032	68.5 cm	17,99
FA360033	87.5 cm	17,99
FA360034	99.5 cm	17,99
FA360035	109.5 cm	17,99

SPEARHEAD



PRODUCT	CODE	DLR €	10%	SEASONAL ORDER 20%	RRP €
MINI SPEAR HEAD INOX	FA390001	7.81	7.03	6.25	12.50
MACH SPEAR HEAD	FA390004	5.31	4.78	4.25	8.50

NYLON 4 POINTS TEMPERED



PRODUCT	CODE		RRP €
NYLON 4 POINTS TEMPERED	FA390011		10.99

MULTIPRONGS

3 - 4 - 5 POINTS

WITH Ø 7MM THREADS
FIT ON Ø 7MM & Ø 8MM SHAFTS

NYLON 3 POINTS TEMPERED



PRODUCT	CODE		RRP €
NYLON 3 POINTS TEMPERED	FA390008		9.50

NYLON 3 POINTS INOX



PRODUCT	CODE		RRP €
NYLON 3 POINTS INOX	FA390015		10.99

NYLON 5 POINTS INOX



PRODUCT	CODE		RRP €
NYLON 5 POINTS INOX	FA390016		16.50



PREMIUM REELS R-SERIES

R20 - R30 - R50

Reels designed for all Cressi arbalette and oleo-pneumatic spearguns with a 40mm capacity reservoir using the oleo-pneumatic reel adapter; it is also possible to mount them on the Victory speargun, without the slide. The frame and the central pin are in AISI 316 steel. The drilling on the frame itself allows it to be used also on arbalette spearguns of different brands. The special clutch

provides an excellent closing torque. The assembly system allows easy maintenance and cleaning. All sizes are equipped with a rewinder ring and size R50 is also equipped with an anti-blocking roller. The models R30 and R50 are equipped with a lightened drum in order to weigh as little as possible on the balance of the speargun.

TECHNICAL FEATURES

- For All Cressi Spearguns except APACHE
- Reel of sturdy construction that combines the resistant Nylon material with assembly elements in AISI316 stainless steel
- Constructed from a single piece of Nylon
- Stainless steel mechanism
- Length for line: 50 m - 160 ft with line Ø 1.5 mm
- Dovetail mounting for quick assembly, compatible with many Cressi rifle models



REMOVABLE DOVETAIL COUPLING FOR DIRECT MOUNTING

LIGHTENED GLASS-FILLED TECHNOPLYMER LINE SPOOL

NO FRICTION RESIN GUIDE ROLLER

CNC MACHINED AISI 316 LASER WELDED FRAME

AISI 316 STEEL CLUTCH

MICROMETRIC CLUTCH ADJUSTMENT

NO FRICTION RESIN LINE ROLLER

LARGE REEL HANDLE WITH NO-FRICTION SLEEVE

PRODUCT	CODE	RRP €
REEL R20	FA359020	49.99
REEL R30	FA359030	55.99
REEL R50	FA359050	69.99

OLEOPNEUMATIC REEL ADAPTER

Support for mounting reels on oleo-pneumatic spearguns with 40 mm reservoir.



PRODUCT	CODE	RRP €
REEL ADAPTER	FA359200	19.99

REELS FISHING REEL

TECHNICAL FEATURES

- Durable-and-Effective
- Smooth Multi-Adjustable Clutch Style Drag System
- Clutch Style Drag System, Adjustable when Paying-Out Line
- Ergonomic Easily Accessible Star Adjusting Knob
- Vertical Mount Design for Minimal Drag
- Material: Non-Corrosive, Durable and Impact Resistant Plastic
- Dimension: 10.9 x 15 x 9.4 centimeters
- **Not suitable for VICTORY and APACHE**



PRODUCT	CODE	RRP €
FISHING REEL	FA359001	29.99

/ SPEARGUNS ACCESSORIES

WISHBONE STANDARD



CODE		RRP €
FA350022		7,50

SPEARGUN OIL 100 ml



CODE		RRP €
FA390022		5,99

JOINTED WISHBONE - A



CODE		RRP €
FA350020		22,99

24 PCS ASSORTED DYNAPLAM Ø 1,5MM

24 mini reels in card box display, assorted colors:

- Dyneema s4 78 core
- Polyester cover
- Seawater Resistant
- UV Resistant

DIAMETER: 1.5 mm
LENGTH: 50mt



NEW 2025



PRODUCT	CODE	DLR €	10%	SEASONAL ORDER 20%	RRP €
24 PCS ASSORTED DYNAPLAM Ø 1.5mm	FA3541099	399,99	359,99	319,99	-

GAUGE FOR GUNS



PRODUCT	CODE		RRP €
SL/SL STAR	FA390020		135,99
MACH	FA390032		135,99

SHAFT LOADER

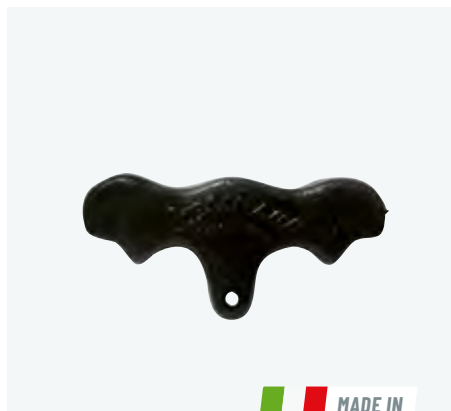

CODE		RRP €
FA390018		3,99

HAND PUMP



PRODUCT	CODE		RRP €
SL/SL STAR	FA320060		26,99
MACH	FZ370073		26,99



LINE FOR REEL



NEW 2025

DIAMETER: 2 mm
LENGTH: 200 mt

CODE		RRP €
FA353200		64,99

MULTIFILAMENT RED Ø 1,5MM

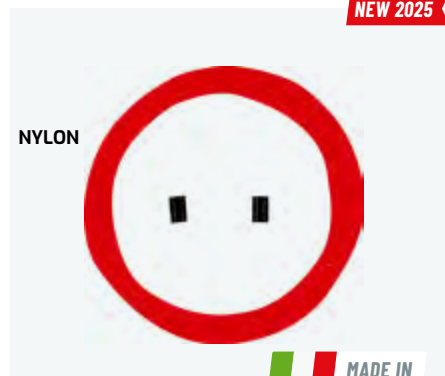

NEW 2025

NYLON

DIAMETER: 1.5 mm
LENGTH: 5mt



CODE		RRP €
FA3542580		5,99

MULTIFILAMENT BLACK Ø 1,5MM



NEW 2025

NYLON

DIAMETER: 1.5 mm
LENGTH: 5mt



CODE		RRP €
FA3542550		5,99

HIGH TENACITY LINE



NEW 2025

DIAMETER: 2.5 mm
LENGTH: 200 mt

CODE		RRP €
FA390230		79,99

COMPETITION FLOPPERS



10 PCS. PACK

CODE		RRP €
FA354520		4,99

FISH HOLDER



CODE		RRP €
FA354526		10,99



SHOCK ABSORBER



CODE		RRP €
FA354603		14,50

CRIMPING TOOL



CODE		RRP €
FA354001		24,99



Photo by: Voyages of Agape

LAMPUGA SPECIALIZED Retailer-Product

TWO-PIECE WETSUIT 5 mm, 7+5 mm

INSPIRED BY THE LIVELY OF THE PELAGIC FISH

A special digital printing system has been used for this new camouflage wetsuit, allowing high-resolution images to be obtained and thus create an exclusive camouflage design. The new "Cryptic Camouflage Technology" of Cressi is based on a real image of a fish (a dolphin fish in this case, with

its dominant colours), to create camouflage that is very close to the original and then altered to obtain a repetitive effect that is one of a kind. The wetsuit is manufactured in two separate 5 or 7 mm pieces (jacket and pants). The materials used are: highly-elastic camo on the outside, open-cell neoprene on the inside.

HIGH WAISTED TROUSERS

16-24° C
60.8-75.2° F
CE CERTIFICATION
DIVING WETSUIT
EN 14225-1:2017: C

5 mm
CE

10-18° C
50-64.4° F
CE CERTIFICATION
DIVING WETSUIT
EN 14225-1:2017: B

7 mm
CE

PADDED CHEST REINFORCEMENT

CRYPTIC CAMOUFLAGE TECHNOLOGY

TECHNICAL FEATURES

- Preformed anatomical cut
- Jacket with padded reinforcement on the chest
- Watertight seals in smooth skin on hood, wrists and ankles
- Reinforced anti-abrasion lining on the chest and knees
- High-waisted trousers with watertight seals on the ankles and waist



Smooth skin watertight seals



Protective reinforcement Aqua stop system



Single piece underarm section



Chest reinforcement Kneepad



PRODUCT	CODE	RRP €
LAMPUGA MAN 2-PIECE WETSUIT CAMOU 5mm S/2	LU490102	299,99
LAMPUGA MAN 2-PIECE WETSUIT CAMOU 5mm M/3	LU490103	299,99
LAMPUGA MAN 2-PIECE WETSUIT CAMOU 5mm L/4	LU490104	299,99
LAMPUGA MAN 2-PIECE WETSUIT CAMOU 5mm XL/5	LU490105	299,99
LAMPUGA MAN 2-PIECE WETSUIT CAMOU 5mm 2XL/6	LU490106	299,99
LAMPUGA MAN 2-PIECE WETSUIT CAMOU 7+5mm S/2	LU490202	319,99
LAMPUGA MAN 2-PIECE WETSUIT CAMOU 7+5mm M/3	LU490203	319,99
LAMPUGA MAN 2-PIECE WETSUIT CAMOU 7+5mm L/4	LU490204	319,99
LAMPUGA MAN 2-PIECE WETSUIT CAMOU 7+5mm XL/5	LU490205	319,99
LAMPUGA MAN 2-PIECE WETSUIT CAMOU 7+5mm 2XL/6	LU490206	319,99



POSIDONIA



SPECIALIZED
Retailer-Product

NEW 2025

PADDED CHEST REINFORCEMENT
CRYPTIC CAMOUFLAGE TECHNOLOGY

HIGH WAISTED TROUSERS

16-24° C
60.8-75.2° F
CE CERTIFICATION
DIVING WETSUIT
EN 14225-1:2017: C

5 mm
CE

10-18° C
50-64.4° F
CE CERTIFICATION
DIVING WETSUIT
EN 14225-1:2017: B

7 mm
CE

CAMOUFLAGE TWO-PIECE WETSUIT 5, 7 mm

This new camouflage suit uses a special digital printing system that allows for very high resolution images to create an exclusive camouflage. Cressi's new 'Cryptic Camouflage Technology' is based on a real image of the fish (in this case the anglerfish with its dominant colours) to create a camouflage that is very similar to the original and then modified to create a unique and repetitive effect. The wetsuit consists of two parts (jacket and trousers) of 5, 7 mm. The materials used are:

highly elasticised camouflage on the outside, split neoprene on the inside. The cut is derived from the Tracina model, now recognised as a very wearable model. The new chest reinforcement is designed to ensure a strong grip when loading rifles. The new reinforcement on the knees offers additional protection against chafing without compromising the elasticity of the materials.



SIZE	JACKET 5MM	RRP €
S/2	LE470502	184,99
M/3	LE470503	184,99
L/4	LE470504	184,99
XL/5	LE470505	184,99
2XL/6	LE470506	184,99

SIZE	JACKET 7MM	RRP €
S/2	LE470702	199,99
M/3	LE470703	199,99
L/4	LE470704	199,99
XL/5	LE470705	199,99
2XL/6	LE470706	199,99

SIZE	PANTS 5MM	RRP €
S/2	LE470512	139,99
M/3	LE470513	139,99
L/4	LE470514	139,99
XL/5	LE470515	139,99
2XL/6	LE470516	139,99

SIZE	PANTS 7MM	RRP €
S/2	LE470712	169,99
M/3	LE470713	169,99
L/4	LE470714	169,99
XL/5	LE470715	169,99
2XL/6	LE470716	169,99

TECHNICAL FEATURES

- Preformed anatomical cut
- Jacket with padded reinforcement on the chest
- Watertight seals in smooth skin on hood, wrists and ankles
- Reinforced anti-abrasion lining on the chest and knees
- High-waisted trousers with watertight seals on the ankles and waist



Smooth skin watertight seals

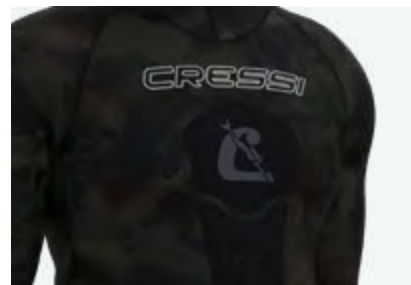

Chest reinforcement

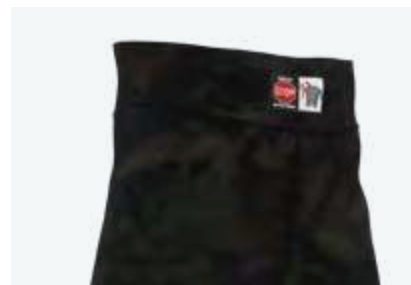

Aqua stop system



Kneepad

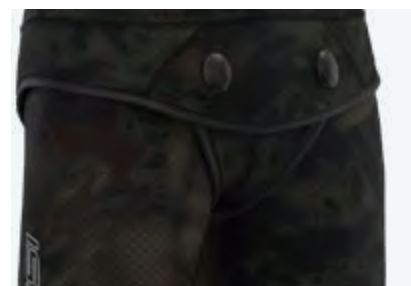

SEPPIA SPECIALIZED Retailer-Product

PADDED CHEST REINFORCEMENT

HIGH WAISTED TROUSERS

>22° C
>71.6° F
CE CERTIFICATION DIVING WETSUIT EN 14225-1:2017: D

3.5 mm CE

16-24° C
60.8-75.2° F
CE CERTIFICATION DIVING WETSUIT EN 14225-1:2017: C

5 mm CE

10-18° C
50-64.4° F
CE CERTIFICATION DIVING WETSUIT EN 14225-1:2017: B

7 mm CE

TWO-PIECE WETSUIT 3.5 mm, 5 mm, 7 mm

WHEN WET CHANGES COLOUR ACCENTUATING MIMETISM

Wetsuit created with the exclusive new Cressi green / brown camouflage, computer-designed to make it more difficult for prey to create solid images, thereby confusing the wearer with the

background. Preformed anatomical cut. Jacket with padded reinforcement on the chest. Smooth skin with watertight seals on hood, wrists and ankles. Reinforced anti-abrasion lining on the chest and knees. High-waisted trousers with watertight seals on the ankles and waist.



TECHNICAL FEATURES



Smooth skin watertight seals



Protective reinforcement



Single piece underarm section



Chest reinforcement Kneepad

SIZE	JACKET 3.5MM	RRP €
S/2	LE468002	164.99
M/3	LE468003	164.99
L/4	LE468004	164.99
XL/5	LE468005	164.99
2XL/6	LE468006	164.99

SIZE	JACKET 5MM	RRP €
S/2	LE468202	184.99
M/3	LE468203	184.99
L/4	LE468204	184.99
XL/5	LE468205	184.99
2XL/6	LE468206	184.99

SIZE	JACKET 7MM	RRP €
S/2	LE468402	209.99
M/3	LE468403	209.99
L/4	LE468404	209.99
XL/5	LE468405	209.99
2XL/6	LE468406	209.99

SIZE	PANTS 3.5MM	RRP €
S/2	LE468102	124.99
M/3	LE468103	124.99
L/4	LE468104	124.99
XL/5	LE468105	124.99
2XL/6	LE468106	124.99

SIZE	PANTS 5MM	RRP €
S/2	LE468302	144.99
M/3	LE468303	144.99
L/4	LE468304	144.99
XL/5	LE468305	144.99
2XL/6	LE468306	144.99

SIZE	PANTS 7MM	RRP €
S/2	LE468502	174.99
M/3	LE468503	174.99
L/4	LE468504	174.99
XL/5	LE468505	174.99
2XL/6	LE468506	174.99

TRACINA

CHEST REINFORCEMENT

HIGH WAISTED TROUSERS

>22° C
>71.6° F
CE CERTIFICATION
DIVING WETSUIT
EN 14225-1:2017: D

3.5 mm
CE

16-24° C
60.8-75.2° F
CE CERTIFICATION
DIVING WETSUIT
EN 14225-1:2017: C

5 mm
CE

10-18° C
50-64.4° F
CE CERTIFICATION
DIVING WETSUIT
EN 14225-1:2017: B

7 mm
CE

TWO-PIECE WETSUIT 3.5 mm, 5 mm, 7 mm

DISAPPEARS INTO THE SEABED

Wetsuit created with the exclusive new Cressi camouflage Dark Digital Specter Pat, computer designed to make it more difficult for prey to create solid images, thereby confusing the wearer with the background. Preformed anatomical cut. Jacket with padded reinforcement in the chest,

Smoothskin watertight seals on the hood, wrists, and waist, and reinforced Powertex lining at the elbows and waist. High-waisted trousers with watertight Smoothskin seals at the ankles and waist, and Powertex reinforcements on the knees. Camouflage color: Dark-Specter.



TECHNICAL FEATURES



Smooth skin watertight seals

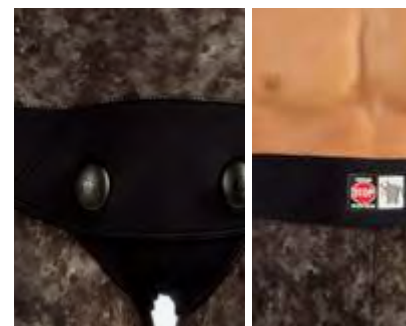

Protective reinforcement Aqua stop system



Chest reinforcement Kneepad

SIZE	JACKET 3.5MM	RRP €
S/2	LE464802	154.99
M/3	LE464803	154.99
L/4	LE464804	154.99
XL/5	LE464805	154.99
2XL/6	LE464806	154.99

SIZE	JACKET 5MM	RRP €
S/2	LE465002	164.99
M/3	LE465003	164.99
L/4	LE465004	164.99
XL/5	LE465005	164.99
2XL/6	LE465006	164.99

SIZE	JACKET 7MM	RRP €
S/2	LE465202	199.99
M/3	LE465203	199.99
L/4	LE465204	199.99
XL/5	LE465205	199.99
2XL/6	LE465206	199.99

SIZE	PANTS 3.5MM	RRP €
S/2	LE464902	114.99
M/3	LE464903	114.99
L/4	LE464904	114.99
XL/5	LE464905	114.99
2XL/6	LE464906	114.99

SIZE	PANTS 5MM	RRP €
S/2	LE465102	124.99
M/3	LE465103	124.99
L/4	LE465104	124.99
XL/5	LE465105	124.99
2XL/6	LE465106	124.99

SIZE	PANTS 7MM	RRP €
S/2	LE465302	149.99
M/3	LE465303	149.99
L/4	LE465304	149.99
XL/5	LE465305	149.99
2XL/6	LE465306	149.99

APNEA

TWO-PIECE WETSUIT 3.5 mm, 5 mm, 7 mm

PERFECT ALSO FOR FREEDIVING

A well-cut suit with particular attention to comfort around the areas where the body suffers most friction. Internal layer in metallic

black and a thickness of 3,5 mm, 5 mm and 7 mm. New design of the loading/reloading chestplate and special kneepads for extra protection.

CHEST REINFORCEMENT

HIGH WAISTED TROUSERS

 >22° C
 >71.6° F
 CE CERTIFICATION
 DIVING WETSUIT
 EN 14225-1:2017: D

3.5 mm
CE

 16-24° C
 60.8-75.2° F
 CE CERTIFICATION
 DIVING WETSUIT
 EN 14225-1:2017: C

5 mm
CE

 10-18° C
 50-64.4° F
 CE CERTIFICATION
 DIVING WETSUIT
 EN 14225-1:2017: B

7 mm
CE



TECHNICAL FEATURES



Protective reinforcement



Chest reinforcement Kneepad

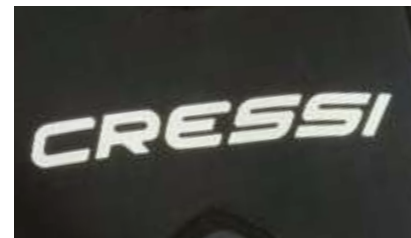

SIZE	3.5MM		RRP €
S/2	LE450102		229,99
M/3	LE450103		229,99
L/4	LE450104		229,99
XL/5	LE450105		229,99
2XL/6	LE450106		229,99

SIZE	5MM		RRP €
S/2	LE450202		249,99
M/3	LE450203		249,99
L/4	LE450204		249,99
XL/5	LE450205		249,99
2XL/6	LE450206		249,99

SIZE	7MM		RRP €
S/2	LE450302		299,99
M/3	LE450303		299,99
L/4	LE450304		299,99
XL/5	LE450305		299,99
2XL/6	LE450306		299,99

TOKUGAWA

MONOPIECE WETSUIT 3 mm

DESIGNED FOR BLUE WATER SPEARFISHING

Tokugawa, named after the Japanese feudal shogunate, is a one-piece 3 mm thick wetsuit, perfect for spearfishing, freediving and swimming, as well as for open water and pool training. The unique camouflage of this wetsuit is appropriate for different aquatic environments, from the blue waters of the Caribbean Sea to the greener tones of North American waters. The wetsuit's graphics provide the ultimate in camouflage for

all environments. Tokugawa, which is made of elastic, flexible, comfortable and soft neoprene, has an anatomically designed cut specific to Cressi wetsuits, with preformed arms and legs that improve wearability and movement in the water. The chest and the knee pad reinforcements are designed specifically for spearfishing. The Dura Stretch nylon lining improves the wetsuit's elasticity, comfort and durability.



FOR SPEARFISHING, FREEDIVING & SWIMMING

CAMOUFLAGE DESIGN

REAR ZIPPER

TECHNICAL FEATURES



Reinforced seams on wrists and ankles



Back zip



Chest reinforcement



Kneepad



PRODUCT	CODE		RRP €
TOKUGAWA MAN MONOPIECE WETSUIT BLUE CAMO 3mm XS/1	LU490001		179.99
TOKUGAWA MAN MONOPIECE WETSUIT BLUE CAMO 3mm S/2	LU490002		179.99
TOKUGAWA MAN MONOPIECE WETSUIT BLUE CAMO 3mm M/3	LU490003		179.99
TOKUGAWA MAN MONOPIECE WETSUIT BLUE CAMO 3mm L/4	LU490004		179.99
TOKUGAWA MAN MONOPIECE WETSUIT BLUE CAMO 3mm XL/5	LU490005		179.99
TOKUGAWA MAN MONOPIECE WETSUIT BLUE CAMO 3mm 2XL/6	LU490006		179.99

/ SPEARFISHING WETSUITS



SPEARFISHING NEOPRENE



Photo by: Andrea Settimi

QUICK DRY FABRIC

50+ UV PROTECTION

HIGHLY STRETCHABLE

HOODED RASHGUARD

COBIA

LONG SLEEVES CAMOU RASHGUARD

The Cobia is the ultimate rash guard that features a chest area completely made in 1mm premium Neoprene to provide extra warmth. It's hooded to give the opportunity to protect and to heat also the head. The Cobia can be worn under a wetsuit for give more warmth and protection. Can be used in any water sports, from windsurfing to scuba diving.

TECHNICAL FEATURES

- The Cobia is the ultimate rash guard that features a chest area completely made in 1mm premium Neoprene to provide extra warmth.
- Hood for head protection.
- Wearable under or over a wetsuit for improve the warmth.
- Available in Cressi's mimetic pattern blue.
- Excellent anatomic cuts.

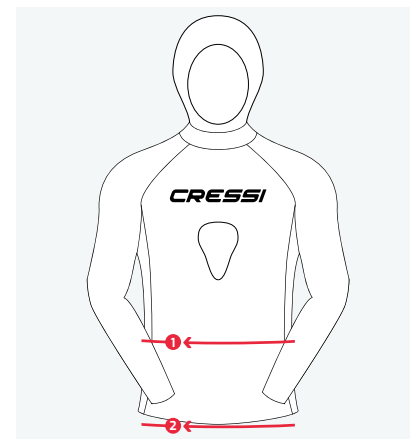

MAN	HEIGHT	(1) CHEST	(2) WAIST
S	160/175 cm 5'3"/5'9"	75/85 cm 30/33 in	63/73 cm 24/29 in
M	165/180 cm 5'5"/5'11"	84/93 cm 33/37 in	69/79 cm 27/31 in
L	175-185 cm 5'9"/6'1"	90/100 cm 35/39 in	75/85 cm 30/33 in
XL	178-190 cm 5'10"/6'3"	98/109 cm 39/43 in	81/91 cm 32/36 in
2XL	185-195 cm 6'1"/6'5"	108/117 cm 43/46 in	89/97 cm 34/38 in
3XL	190-200 cm 6'3"/6'7"	115-125 cm 45/49 in	93-103 cm 37/41 in

PRODUCT	CODE		RRP €
COBIA BLUE HUNTER RASH GUARD S	USW011102B		99,99
COBIA BLUE HUNTER RASH GUARD M	USW011103B		99,99
COBIA BLUE HUNTER RASH GUARD L	USW011104B		99,99
COBIA BLUE HUNTER RASH GUARD XL	USW011105B		99,99
COBIA BLUE HUNTER RASH GUARD 2XL	USW011106B		99,99
COBIA BLUE HUNTER RASH GUARD 3XL	USW011107B		99,99

BACKWEIGHT

ONE SIZE 3 mm

Ballast holder backplate with quick release buckles and 6 handy pockets for traditional ballast or spherical lead weights. The high density neoprene eliminates trim variations and ensures better weight retention. Automatic release of the vest when one of the buckles is released.



UP TO 6 KGS

PRODUCT	CODE		RRP €
BACKWEIGHT BLACK	LE500000		49,99

SARAGO

SOFT HIGHLY ELASTIC NYLON-LINED NEOPRENE | ANTI-SLIP GRIP SOLE

THERMAL NEOPRENE SOCKS 3, 5 mm

These socks for fins with strap or foot pocket are made of soft highly elastic nylonlined NEW camouflage neoprene 3 mm. They prevent heat loss and keep feet warm. The smooth skin neoprene on the ankle allows maximum adherence between the sock and the leg of the wetsuit, reducing the passage of water. The sole is entirely non-slip. The construction of the blind stitch seam further improves comfort and aesthetics.



BROWN

BLACK

SMOOTH SKIN NEOPRENE

ANTI-SLIP GRIP SOLE



SIZE	EU	THK	BROWN	BLACK		RRP €
S	38-39	3 mm	XLX434312	XLX434301		34,99
M	40-41	3 mm	XLX434313	XLX434302		34,99
L	42-43	3 mm	XLX434314	XLX434303		34,99
XL	44-45	3 mm	XLX434315	XLX434304		34,99
2XL	46-47	3 mm	XLX434316	XLX434305		34,99
S	38-39	5 mm	-	XLX440502		39,99
M	40-41	5 mm	-	XLX440503		39,99
L	42-43	5 mm	-	XLX440504		39,99
XL	44-45	5 mm	-	XLX440505		39,99
2XL	46-47	5 mm	-	XLX440506		39,99

TRACINA CAMO

THERMAL NEOPRENE SOCKS 3 mm

Socks in Ultraspan, 3 mm elastic and hydrodynamic lining. Microporous inner lining with Blacklite® coating for greater thermal protection and waterproofing without the need to use soapy water to wear them. Nylon inner sole to prevent the foot from slipping inside when walking. Model designed according to the position of the foot during movement to avoid creases and tensions in the area of the instep.

ANTI-SLIP GRIP SOLE



PRODUCT	THK	SIZE	BROWN		RRP €
TRACINA SOCKS CAMOU	3 mm	S	LX433201		44,99
TRACINA SOCKS CAMOU	3 mm	M	LX433202		44,99
TRACINA SOCKS CAMOU	3 mm	L	LX433203		44,99
TRACINA SOCKS CAMOU	3 mm	XL	LX433204		44,99

HEX

CUT RESISTANT GLOVES

Cressi designed a glove that provides high comfort and dexterity while being cut puncture and impact-resistant, making it ideal for lobstering and spearfishing. The wrist velcro closer will always keep the glove in place, regardless of normal use expansion from water weight. Cressi's Dyfiber material offers maximum strength with minimum weight. It features the ANSI level 4 for cut resistance and level 3 for puncture resistance.

CUT RESISTANCE
LVL 4

PUNCTURE RESISTANCE
LVL 3

BACK AND FINGERS
SPECIAL PROTECTION

OPTIMAL GRIP IN
ALL CONDITIONS

TECHNICAL FEATURES

- ANSI Cut resistance level 4. Puncture resistance level 3.
- The back, knuckles and fingers have special protection against bumps and scratches.
- Palm in Sandy Nitrile coating increasing grip in wet and oily conditions.



PRODUCT	THK	SIZE	CODE		RRP €
HEX GRIP GLOVES	3 mm	XS	PQ100601		49,99
HEX GRIP GLOVES	3 mm	S	PQ100602		49,99
HEX GRIP GLOVES	3 mm	M	PQ100603		49,99
HEX GRIP GLOVES	3 mm	L	PQ100604		49,99
HEX GRIP GLOVES	3 mm	XL	PQ100605		49,99
HEX GRIP GLOVES	3 mm	2XL	PQ100606		49,99

TRACINA CAMO NET BAG

THERMAL NEOPRENE GLOVES 3 mm

3 mm camouflage version with 100% ULTRASpan outer coating. It offers great elasticity, comfort, hydrodynamics and quick drying. Microporous interior with Blacklite® coating for greater thermal protection and watertightness without the need to use soapy water to wear them. Fully lined with latex picot for better grip and durability. Preformed 3D model.



SIZE	CODE		RRP €
S	LX477501		49,99
M	LX477502		49,99
L	LX477503		49,99
XL	LX477504		49,99

NET BAG

Made of durable nylon, the bag features a large carrying capacity and an adjustable strap to fit the user's needs. The elastic opening provides quick and easy access to contents, while the wide mesh allows water to drain away without creating resistance. Lightweight and easy to carry, the bag is an indispensable ally for every outing at sea.



CODE		RRP €
TA615100		14,99



NEREUS

FLUORESCENT HOUR, MINUTE/SECOND HANDS
 UNIDIRECTIONAL BEZEL CLEARLY MARKED
 PROVEN QUARTZ MECHANISM
 STAINLESS STEEL CASE, CRYSTAL GLASS FACE AND WATERPROOF CROWN

ANALOG CHRONOGRAPH WATCH

Designed in Italy by Cressi, this watch can be used during water sports or in physical education and sometimes during training. It is practical, quick and easy to use. Fluorescent hour /

minute / second hands are easy to read in low-light conditions.

TECHNICAL FEATURES

Water resistance	200 m / 660 ft / 20 atm. Unidirectional bezel clearly marked for tracking dive time
Strap material	rubber / silicone / PU (polyurethane)
Stainless steel case diameter	48 mm. Hardened mineral crystal glass face and waterproof crown
Functions	time and stopwatch that can be started or stopped by pressing the three buttons on the side of the watch. Quartz mechanism for precision timekeeping



SILVER/BLUE



FULL BLACK



BLACK/BLACK



COLOR	CODE	RRP €
BLACK/BLACK	XK5765055	179,99
FULL BLACK	XK5765056	179,99
SILVER/BLUE	XK5765062	179,99
WATCHSTRAP BLACK	KZ764801	29,99

TRAVELLER DUAL TIME

THE IDEAL WATCH FOR TRAVELLING

Traveller, the Cressi dive watch that's resistant to 200m/20ATM, is a confirmed success, offered in various bright colours. Useful for travellers as it offers dual time zones. It features a magnifying lens

on the calendar, a rugged steel case, a black face with fluorescent points, mineral glass, and a comfortable strap made of soft rubber.

ROTATING BEZEL
MAGNIFYING LENS ON THE CALENDAR
BROAD CLOCK FACE WITH FLOURESCENT POINTS
DUAL TIMES
MINERAL GLASS

TECHNICAL FEATURES

Water resistance	200 m / 660 ft / 20 atm. Ample clock face with rotating bezel. Dual times Strap in soft rubber
Strap material	Soft rubber



GOLD

BLUE



COLOR	CODE	RRP €
GOLD	K5766002	169,99
BLUE	XK5766020	169,99

MANTA

100m WATERPROOF WATCH

Cressi Manta is a professional dive watch, resistant to 100m/10 ATM. Its rugged, sporty look reflects its technical characteristics. It features a broad face that shows the hours in fluorescent paint.

FLUORESCENT HANDS AND MARKERS
AMPLE CLOCK FACE
STAINLESS STEEL CASE
PROVEN QUARTZ MECHANISM FOR PRECISION TIME KEEPING

The mineral glass is encircled by the rotating time-keeper bezel with the fluorescent 0 point. The stainless steel case is 13 mm thick. Battery powered quartz movement, extra-flat bottom with screw closure.

TECHNICAL FEATURES

Water resistance	100 m / 10 atm
Features	<ul style="list-style-type: none"> · Time-keeper and unidirectional bezel · Screw down crown waterproof · Mineral glass · Soft, extra-large rubber strap · Indicates hours, minutes, seconds, and date · Silent



BLACK/SILVER

RED



BLUE

ORANGE

BLACK/BLACK

BLACK/ORANGE

BLACK/BLUE

COLOR	CODE	RRP €
BLACK BLACK SILVER CASE	XK5764755	149,99
BLACK RED	XK5764758	149,99
BLACK BLUE	XK5764752	149,99
BLACK ORANGE	XK5764785	149,99
BLACK BLACK- BLACK CASE	XK5764750	149,99
BLACK BLACK ORANGE	XK57647585	149,99
BLACK BLACK BLUE	XK57647520	149,99
STRAP MANTA RUBBER BLACK	KZ764700	29,99



BOTTLES

TISK THERMAL FLASK

500 ML | DOUBLE WALL VACUUM TECHNOLOGY

STAINLESS STEEL INSULATED BOTTLE WITH DOUBLE CAPS

Tisk is the Cressi bottle designed for everyday life, for enjoy your favorite drink without any alteration of taste thanks to the stainless steel material inside. Tisk is made with double-wall vacuum technology that allows maintain the temperature

of the liquids up to 12 hours for hot drink and 24 hours for cold drink. Tisk is equipped with a double interchangeable cap, the Sporty cap with "one-handed" fast opening and the Regular cap. The silicone coating is removable and washable.

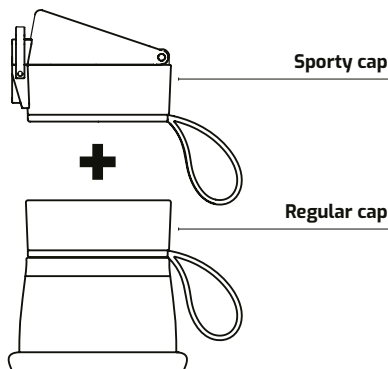

TECHNICAL FEATURES

- Silicone sleeve** A soft touch silicone coat for improved hand grip and absorb shocks, removable and washable
- Double walled insulation** Composed by a double layers of stainless steel wall separated by vacuum for long time thermal keeping
- Double caps** One Sporty cap with one hand opening for fast drinking, one Regular cap for a steady flowing



PRODUCT	CODE	RRP €
500ML BLUE NAVY	XVA709023	34,99

WATER BOTTLE H₂O

400 ML | DOUBLE WALL VACUUM TECHNOLOGY | INSULATED CAP

FROSTED

Our sports Bottle is designed for those who have an active life. Love physical activities and spend a lot of time outdoors. Are you passionate about cycling, running, Hiking or climbing perfect. With this bottle you will always be Hydrated. You can even use this gym bottle for your favourite energy

drinks. The water Bottle is made of high quality materials. Designed to last over time. Attention: do Not wash in the dishwasher. We recommend washing the water Bottle in hot water with a drop of neutral dish detergent. Avoid aggressive chemical agents and brushes.



TECHNICAL FEATURES

- The Cressi Water bottle will be your ideal companion in every situation
- Take it with you to school, University, work or your outings on the go
- The elegant design of this bottle with lid will allow you to keep your favorite drinks at the desired temperature



PRODUCT	CODE	*CASE PACK	RRP €
600 ml BLACK	XVA670650	3	19,99
600 ml OCTOPUS BLACK	XVA670625	3	19,99

APPAREL





T-SHIRT

MAN & LADY

Premium quality 100% cotton t-shirt, available in two colors and different fit for man and woman. Front and back printed logos.

Smooth collar and sleeve hem for maximum comfort.



Fabric	30/1 Jersey 100% Cotton, 150 gr
Color	Yellow / Black
Print	Front + Back + Inside neck



YELLOW



BLACK

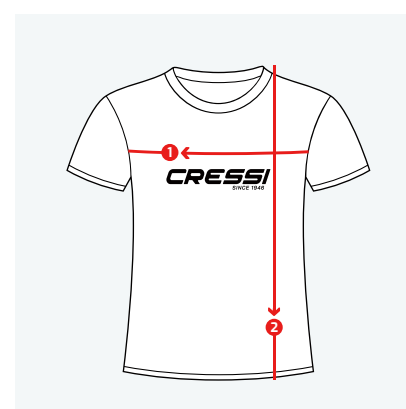

MAN	(1) CHEST	(2) LENGTH
XS	48 cm (18.8 inch)	65 cm (25.6 inch)
S	50 cm (19.6 inch)	67 cm (26.4 inch)
M	52 cm (20.4 inch)	69 cm (27.1 inch)
L	54 cm (21.2 inch)	71 cm (28 inch)
XL	56 cm (22 inch)	73 cm (28.7 inch)
2XL	58 cm (22.8 inch)	75 cm (29.5 inch)
3XL	60 cm (23.6 inch)	77 cm (30.3 inch)

LADY	(1) CHEST	(2) LENGTH
XS	40 cm (15.7 inch)	60 cm (23.6 inch)
S	42 cm (16.5 inch)	62 cm (24.4 inch)
M	44 cm (17.3 inch)	62 cm (24.4 inch)
L	46 cm (18.1 inch)	64 cm (25.2 inch)
XL	48 cm (18.9 inch)	64 cm (25.2 inch)

PRODUCT	CODE	RRP €
CRESSI T-SHIRT MAN YELLOW/BLACK S	VA944112	39.99
CRESSI T-SHIRT MAN YELLOW/BLACK M	VA944113	39.99
CRESSI T-SHIRT MAN YELLOW/BLACK L	VA944114	39.99
CRESSI T-SHIRT MAN YELLOW/BLACK XL	VA944115	39.99
CRESSI T-SHIRT MAN YELLOW/BLACK 2XL	VA944116	39.99
CRESSI T-SHIRT MAN YELLOW/BLACK 3XL	VA944117	39.99
CRESSI T-SHIRT LADY YELLOW/BLACK XS	VA944211	39.99
CRESSI T-SHIRT LADY YELLOW/BLACK S	VA944212	39.99
CRESSI T-SHIRT LADY YELLOW/BLACK M	VA944213	39.99
CRESSI T-SHIRT LADY YELLOW/BLACK L	VA944214	39.99
CRESSI T-SHIRT LADY YELLOW/BLACK XL	VA944215	39.99

PRODUCT	CODE	RRP €
CRESSI T-SHIRT MAN BLACK/YELLOW S	VA944152	39.99
CRESSI T-SHIRT MAN BLACK/YELLOW M	VA944153	39.99
CRESSI T-SHIRT MAN BLACK/YELLOW L	VA944154	39.99
CRESSI T-SHIRT MAN BLACK/YELLOW XL	VA944155	39.99
CRESSI T-SHIRT MAN BLACK/YELLOW 2XL	VA944156	39.99
CRESSI T-SHIRT MAN BLACK/YELLOW 3XL	VA944157	39.99
CRESSI T-SHIRT LADY BLACK/YELLOW XS	VA944251	39.99
CRESSI T-SHIRT LADY BLACK/YELLOW S	VA944252	39.99
CRESSI T-SHIRT LADY BLACK/YELLOW M	VA944253	39.99
CRESSI T-SHIRT LADY BLACK/YELLOW L	VA944254	39.99
CRESSI T-SHIRT LADY BLACK/YELLOW XL	VA944255	39.99



POLO

SHORT SLEEVES - MAN & LADY

This slim-fit golf polo shirt is crafted from 100% 200 gr Cotton, and features three button placket and open-bottom hem. Classic mini stripe yarn dye design. Contrast colour

to underside of collar and sleeves. Embroidered Cressi front logo.

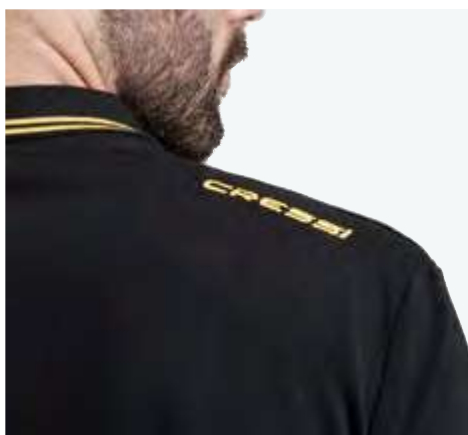
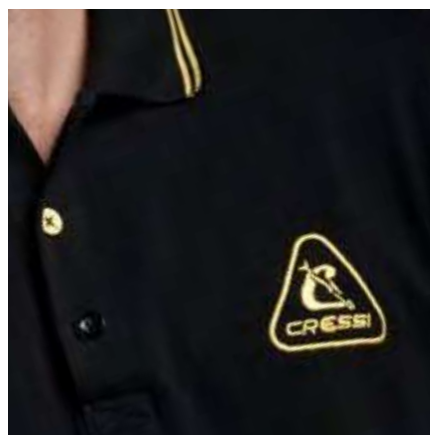

Fabric	30/1 Piquet 100% Cotton, 200 gr
Color	Black

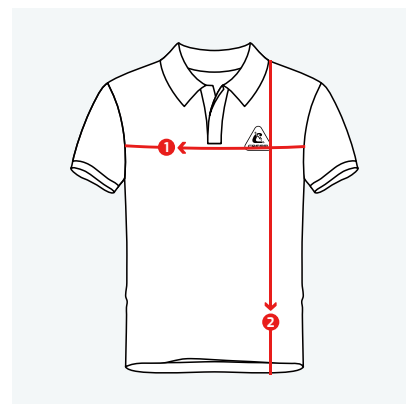

MAN	(1) CHEST	(2) LENGTH
XS	48 cm (18.8 inch)	67 cm (26.4 inch)
S	50 cm (19.6 inch)	69 cm (27.1 inch)
M	52 cm (20.4 inch)	71 cm (28 inch)
L	54 cm (21.2 inch)	73 cm (28.7 inch)
XL	56 cm (22 inch)	75 cm (29.5 inch)
2XL	58 cm (22.8 inch)	77 cm (30.3 inch)
3XL	60 cm (23.6 inch)	79 cm (31.1 inch)

LADY	(1) CHEST	(2) LENGTH
XS	40 cm (15.7 inch)	60 cm (23.6 inch)
S	42 cm (16.5 inch)	62 cm (24.4 inch)
M	44 cm (17.3 inch)	62 cm (24.4 inch)
L	46 cm (18.1 inch)	64 cm (25.2 inch)
XL	48 cm (18.9 inch)	64 cm (25.2 inch)

PRODUCT	CODE	RRP €
CRESSI POLO MAN BLACK/YELLOW S	VA944552	59.99
CRESSI POLO MAN BLACK/YELLOW M	VA944553	59.99
CRESSI POLO MAN BLACK/YELLOW L	VA944554	59.99
CRESSI POLO MAN BLACK/YELLOW XL	VA944555	59.99
CRESSI POLO MAN BLACK/YELLOW 2XL	VA944556	59.99
CRESSI POLO MAN BLACK/YELLOW 3XL	VA944557	59.99
CRESSI POLO LADY BLACK/YELLOW XS	VA944651	59.99
CRESSI POLO LADY BLACK/YELLOW S	VA944652	59.99
CRESSI POLO LADY BLACK/YELLOW M	VA944653	59.99
CRESSI POLO LADY BLACK/YELLOW L	VA944654	59.99
CRESSI POLO LADY BLACK/YELLOW XL	VA944655	59.99



HOODIE

UNISEX

Made of a 95% Cotton and 5% Elastan blend, it features an attached hood with draw-cord closure, front hand-warmer pocket, reinforced rib-knit cuffs and waistband.

The Cressi front logo is embroidered. Inner hood enriched with a geometric texture.



Fabric	Fleece. 95% Cotton, 5% Elastan.
Color	Black
Print	Front + Back + Inside Hood



SIZE	(1) CHEST	(2) LENGTH
XS	50 cm (19.6 inch)	67 cm (26.4 inch)
S	52 cm (20.4 inch)	69 cm (27.1 inch)
M	54 cm (21.2 inch)	71 cm (28 inch)
L	56 cm (22 inch)	73 cm (28.7 inch)
XL	58 cm (22.8 inch)	75 cm (29.5 inch)
2XL	60 cm (23.6 inch)	77 cm (30.3 inch)
3XL	62 cm (24.4 inch)	79 cm (31.1 inch)



PRODUCT	CODE	RRP €
CRESSI HOODIE UNISEX BLACK/YELLOW XS	VA945601	99,99
CRESSI HOODIE UNISEX BLACK/YELLOW S	VA945602	99,99
CRESSI HOODIE UNISEX BLACK/YELLOW M	VA945603	99,99
CRESSI HOODIE UNISEX BLACK/YELLOW L	VA945604	99,99
CRESSI HOODIE UNISEX BLACK/YELLOW XL	VA945605	99,99
CRESSI HOODIE UNISEX BLACK/YELLOW 2XL	VA945606	99,99
CRESSI HOODIE UNISEX BLACK/YELLOW 3XL	VA945607	99,99

HOODIE WITH ZIP

NEW 2025

UNISEX

Made of a 95% Cotton and 5% Elastan blend, it features an attached hood with draw-cord closure, front hand-warmer pocket, reinforced rib-knit cuffs and waistband.

The Cressi front logo is embroidered. Inner hood enriched with a geometric texture.

Fabric	Fleece. 95% Cotton, 5% Elastan.
Color	Black
Print	Front + Back + Inside Hood

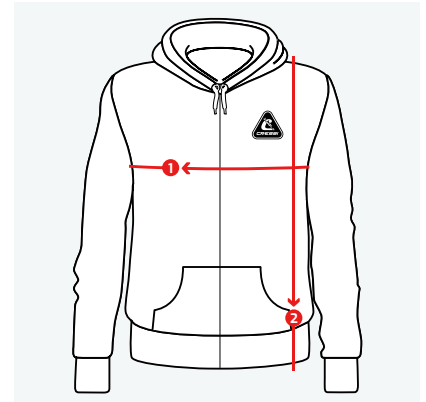

SIZE	(1) CHEST	(2) LENGTH
XS	50 cm (19.6 inch)	67 cm (26.4 inch)
S	52 cm (20.4 inch)	69 cm (27.1 inch)
M	54 cm (21.2 inch)	71 cm (28 inch)
L	56 cm (22 inch)	73 cm (28.7 inch)
XL	58 cm (22.8 inch)	75 cm (29.5 inch)
2XL	60 cm (23.6 inch)	77 cm (30.3 inch)
3XL	62 cm (24.4 inch)	79 cm (31.1 inch)



PRODUCT	CODE	RRP €
CRESSI HOODIE UNISEX BLACK/YELLOW XS	VA950001	99,99
CRESSI HOODIE UNISEX BLACK/YELLOW S	VA950002	99,99
CRESSI HOODIE UNISEX BLACK/YELLOW M	VA950003	99,99
CRESSI HOODIE UNISEX BLACK/YELLOW L	VA950004	99,99
CRESSI HOODIE UNISEX BLACK/YELLOW XL	VA950005	99,99
CRESSI HOODIE UNISEX BLACK/YELLOW 2XL	VA950006	99,99
CRESSI HOODIE UNISEX BLACK/YELLOW 3XL	VA950007	99,99

SWEATPANTS & BERMUDA

UNISEX

Fabric Fleece. 95% Cotton, 5% Elastan.
Color Black



SIZE	CODE	RRP €
XS	VA945701	79,99
S	VA945702	79,99
M	VA945703	79,99
L	VA945704	79,99
XL	VA945705	79,99
2XL	VA945706	79,99



Fabric Fleece. 95% Cotton, 5% Elastan.
Color Black



SIZE	CODE	RRP €
XS	VA945801	59,99
S	VA945802	59,99
M	VA945803	59,99
L	VA945804	59,99
XL	VA945805	59,99
2XL	VA945806	59,99

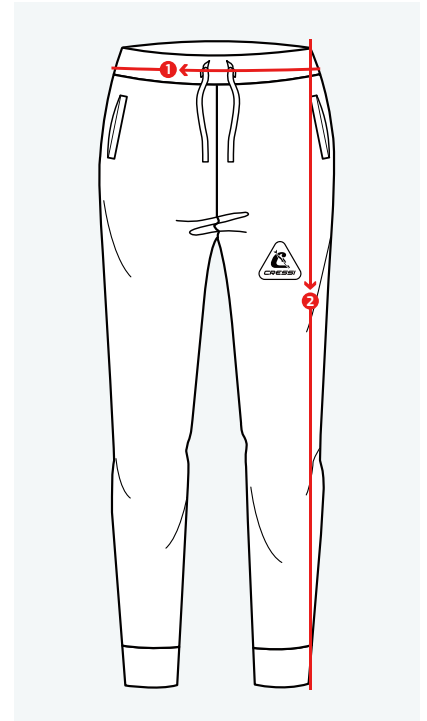

SIZE	(1) WAIST	(2) LENGTH
XS	36 cm (14.2 inch)	102 cm (40.1 inch)
S	38 cm (15 inch)	103 cm (40.5 inch)
M	40 cm (15.7 inch)	104 cm (40.9 inch)
L	42 cm (16.5 inch)	105 cm (41.3 inch)
XL	44 cm (17.3 inch)	106 cm (41.7 inch)
2XL	46 cm (18.1 inch)	107 cm (42.1 inch)
3XL	48 cm (18.9 inch)	108 cm (42.5 inch)

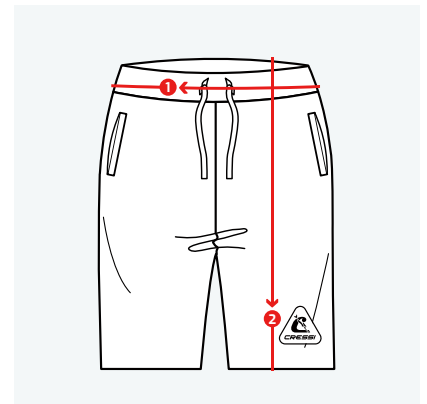

SIZE	(1) WAIST	(2) LENGTH
XS	36 cm (14.2 inch)	49 cm (19.2 inch)
S	38 cm (15 inch)	50 cm (19.6 inch)
M	40 cm (15.7 inch)	51 cm (20 inch)
L	42 cm (16.5 inch)	52 cm (20.4 inch)
XL	44 cm (17.3 inch)	53 cm (20.8 inch)
2XL	46 cm (18.1 inch)	54 cm (21.2 inch)
3XL	48 cm (18.9 inch)	55 cm (21.6 inch)

SOFTSHELL JACKET

UNISEX

100% polyester. Ultralight softshell jacket. Functional fabric with TPU membrane windproof and waterproof

Breathable and vapour-permeable

Sealed seams

Waterproof zipper

Two zippered side pockets.

Adjustable hood.

Slightly longer back.



SIZE	CODE		RRP €
UNISEX XS	VA945901		299.99
UNISEX S	VA945902		299.99
UNISEX M	VA945903		299.99
UNISEX L	VA945904		299.99
UNISEX XL	VA945905		299.99
UNISEX 2XL	VA945906		299.99

CAP

WITH ADJUSTABLE CLOSURE

Fabric 100% Brushed Cotton Twill
260 gr

Color Black



PRODUCT	CODE		RRP €
CRESSI BASEBALL CAP	VA900150		26.99

BEANIE

Fabric Outer 100% Polyacrylic

Lining 100% Polyester (Fleece). 3MTM Thinsulate™ Insulation

Color Black



PRODUCT	CODE		RRP €
CRESSI BEANIE BLACK/YELLOW	VA900250		19.99

FLOATING KEYCHAIN



DESCRIPTION:
Floating foam keychain with snap hook, (no inflation needed).



PRODUCT	CODE	*CASE PACK		RRP €
YELLOW	NY000010	-		5.99
RED	NY000080	10		5.99
TURQUOISE/YELLOW	NY002810	10		5.99
BLACK/YELLOW	NY005010	10		5.99



BRAND SUPPORT

TOWER DISPLAY

MOBILE METAL STAND DISPLAY

60x60x194 cm
23.6x23.6x76 inch



PRODUCT	CODE		RRP €
TOWER DISPLAY BLACK/YELLOW	VAEMOMS		-

HOOK FOR FINS



PRODUCT	CODE		RRP €
HOOK-W UNIT FOR FINS	VAEFINS		-

HOOK FOR WETSUIT



PRODUCT	CODE		RRP €
HOOK-H UNIT FOR WETSUIT	VAEWETSUIT		-

DIVE WATCH & COMPUTER DISPLAY

METAL WALL DISPLAY



PRODUCT	CODE		RRP €
METAL WALL COMPUTER DISPLAY BLACK/YELLOW	VAEUMWC		-

REGULATOR DISPLAY

METAL WALL DISPLAY



PRODUCT	CODE		RRP €
METAL WALL REGULATOR DISPLAY BLACK/YELLOW	VAEUMWR		-

DIVE WATCH & COMPUTER DISPLAY

ACRYLIC TABLE DISPLAY



PRODUCT	CODE		RRP €
ACRYLIC TABLE TOP COMPUTER DISPLAY BLACK/YELLOW	VAEUATT		-

MASK AND SNORKEL DISPLAY

ACRYLIC TABLE DISPLAY



PRODUCT	CODE		RRP €
ACRYLIC TABLE TOP MASK+SNORKEL DISPLAY BLACK/YELLOW	VAEUAMS		-

MASK DISPLAY

ACRYLIC WALL DISPLAY



PRODUCT	CODE		RRP €
WALL MASK DISPLAY BLACK/YELLOW	VAEMASK		-

HOOK FOR GOGGLES

ACRYLIC WALL DISPLAY



PRODUCT	CODE		RRP €
HOOK FOR GOGGLES BLACK/YELLOW	VAEWAGF		-

MASK DISPLAY

FOR FULL FACE



Assembled:
25x20x31 cm
9,84x7,87x12,2 inch
Not assembled:
25x31x3 cm
9,84x12,2x1,18 inch

PRODUCT	CODE		RRP €
WALL DISPLAY	VAEDUKE		-

SNORKEL DISPLAY

ACRYLIC WALL DISPLAY



PRODUCT	CODE		RRP €
WALL SNORKEL DISPLAY BLACK/YELLOW	VAESNOR		-

FLAT DISPLAY

ACRYLIC WALL DISPLAY



PRODUCT	CODE		RRP €
WALL FLAT DISPLAY BLACK/YELLOW	VAEFLAT		-

DISPLAY

SWIM AND SNORKELING PRODUCTS

Includes 50x Hooks to display the products



PRODUCT	CODE		RRP €
DISPLAY	VAESEA		-

DISPLAY

HIGH DISPLAY WITH WHEELS

TECHNICAL FEATURES

Dimensions 50 x 50 x 165 cm
19.7 x 19.7 x 65 inch

Weight 25 kg
55.1 lbs

**BUY 350 PCS OF FOOTWEAR
OF ANY MODEL AND GET
THIS DISPLAY FOR FREE**



PRODUCT	CODE		RRP €
HIGH FOOTWEAR DISPLAY	XVB999910		-

SUNGLASSES DISPLAY

SUNGLASSES METAL DISPLAY

NEW 2025

TECHNICAL FEATURES

Dimensions 75 x 27 x 27 cm
30 x 10.5 x 10.5 inch

Material Metal, Mirror Glass

**BUY 100 PCS OF SUNGLASSES
OF ANY MODEL AND GET
THIS DISPLAY FOR FREE**



PRODUCT	CODE		RRP €
SUNGLASSES METAL DISPLAY	XVAESUNG		-

QUANTUM MASK

POSTER AND DISPLAY



PRODUCT	CODE		RRP €
QUANTUM POSTER 70 X 100 cm	VPOSTERQTM		-
QUANTUM A3 DISPLAY	CARTVETQTM		-

PRODUCTS ADV

A3 DISPLAY

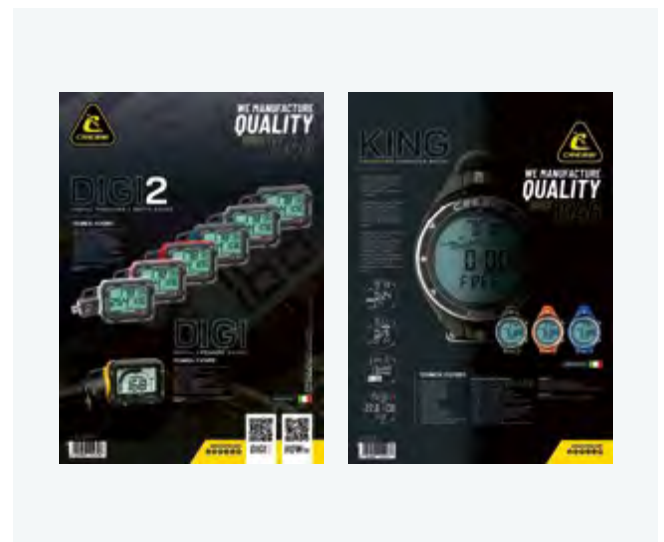

PRODUCT	CODE		RRP €
DIGI 2 + DIGI ADV A3 DISPLAY	CARTVETDGO1		-
KING ADV A3 DISPLAY	CARTVETKNG		-



BANNERS AND FLAGS

CRESSI SINCE 1946

Cressi banners and flags are the ideal support for retailers and events. Three different dimensions and shapes for every need. The choice of the new colours reinforces our corporate image.



BANNER FLAG
350 X 60 CM



RECTANGLE FLAG
150 X 90 CM

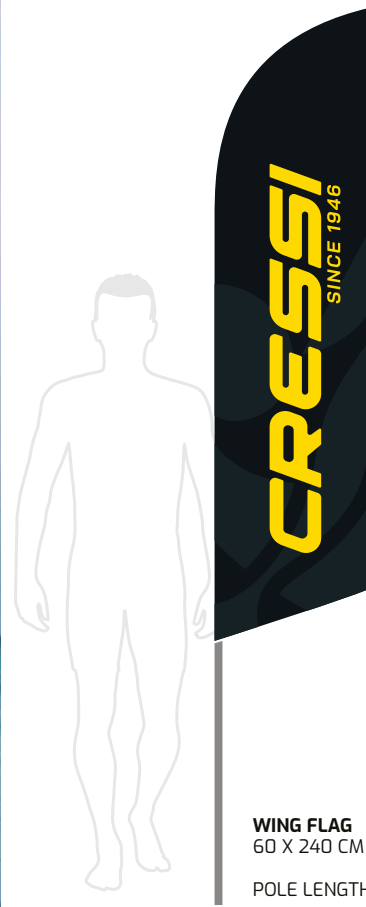

WING FLAG
60 X 240 CM

POLE LENGTH: 340 CM

PRODUCT	CODE	DLR €	10%	SEASONAL ORDER 20%	RRP €
WING 60x240cm	VABANCRO3	15,63	14,07	12,50	-
BANNER 350x60 cm	VABANCRO2	12,81	11,53	10,25	-
RECTANGLE 150x90 cm	VABANCRO1	9,06	8,15	7,25	-

STICKERS

CRESSI SINCE 1946



STICKER
Back adhesive side

XSmall	4 x 3,6 cm 1.57 x 1.41 inch
Small	10 x 9,1 cm 3.94 x 3.58 inch
Basic	30 x 27 cm 11.8 x 10.6 inch
L Size	58,5 x 53 cm 23 x 20.8 inch

PRODUCT	CODE		RRP €
4x3,64 cm	VPADE5310		-
10x9,1 cm	VPADE5210		-
30x27 cm	VPADE5010		-
58,5x53 cm	VPADE5110		-



STICKER
Back adhesive side

Small	15 x 15,3 cm 5.9 x 6 inch
Basic	30 x 30,5 cm 11.8 x 12 inch

PRODUCT	CODE		RRP €
15X15,3 cm	VPADE5211		-
30x30,5 cm	VPADE5011		-



STICKER
Back adhesive side

Size	48 x20,4 cm 18.9 x 8.3 inch
-------------	--------------------------------

PRODUCT	CODE		RRP €
AUT. DEAL. 48x20,4cm	VPADE5012		-

NEW 2025





STICKER
Back adhesive side



- 3pcs x CRESSI TRIANGLE STICKER BLACK/YELLOW 4X3,64 CM
- 3pcs x - CRESSI TRIANGLE STICKER BLACK/YELLOW 10X9,1 CM
- 1pcs x - CRESSI TRIANGLE STICKER BLACK/YELLOW 30X27 CM
- 1pcs x - CRESSI TRIANGLE STICKER BLACK/YELLOW 58,5X53 CM
- 1pcs x - CRESSI TRIANGLE AUT. DEAL STICKER BLACK/YELLOW 15X15,3 CM
- 1pcs x - CRESSI TRIANGLE AUT. DEAL. STICKER BLACK/YELLOW 30X30,5 CM
- 1pcs x - CRESSI RECTANGLE AUT. DEAL. STICKER BLACK/YELLOW 48X20,4 CM

PRODUCT	CODE		RRP €
CRESSI STICKER MEGA PACK	VPADE5000		-

CRESSI CARPET

NEW 2025

WELCOME MAT FOR SHOPS AND OFFICES

Entrance doormat for shops and offices.
DIMENSIONS: 100x70 cm / 39.3 x 27.5 in



PRODUCT	CODE	DLR €	10%	SEASONAL ORDER 20%	RRP €
CRESSI CARPET 100x70cm BLACK/YELLOW	VAECARPET52	24.99	22.49	19.99	-

PHOTO BOOK

THE WATER CONSPIRACY

Photo collection of all the water shapes, produced by Federico Traverso and powered by Cressi.



PRODUCT	CODE	DLR €	10%	SEASONAL ORDER 20%	RRP €
PHOTO BOOK FEDERICO TRAVERSO	VPPB0000	24.99	22.49	19.99	39.99

DISPLAY

CRESSI SINCE 1946

Cressi Since 1946 interior Display Totem is perfect to be exhibited in a shop or during an event.

TECHNICAL FEATURES

Base	Triangular
Dimensions	156 x 60 x 60 x 53cm 61.5 x 23.5 x 23.5 x 21 inch



PRODUCT	CODE	RRP €
CRESSI 1946 DISPLAY TOTEM	TOTEMCR01	-

DISPLAY

SPEARFISHING

Cressi Spearfishing interior Display Totem is perfect to be exhibited in a shop or during an event.

TECHNICAL FEATURES

Base	Triangular
Dimensions	156 x 60 x 60 x 53cm 61.5 x 23.5 x 23.5 x 21 inch



PRODUCT	CODE	RRP €
SPEARFISHING DISPLAY TOTEM	TOTEMSF01	-

BANNERS AND FLAGS

CRESSI DIVE CENTER

Cressi banners and flags are the ideal support for dive centers. Three different dimensions and shapes for every need.



BANNER FLAG
350 X 60 CM



RECTANGLE FLAG
150 X 90 CM

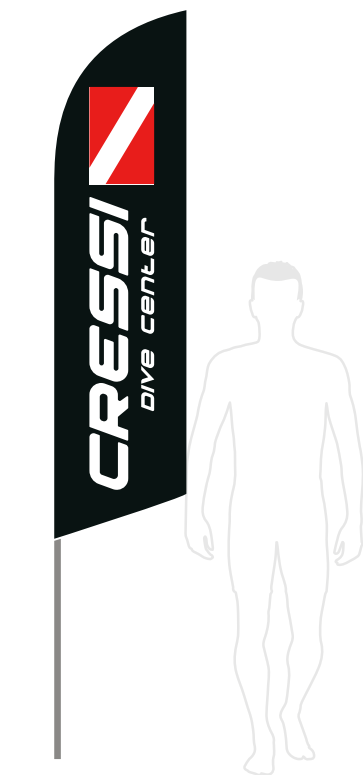

WING FLAG
60 X 240 CM

POLE LENGTH: 340 CM

PRODUCT	CODE		RRP €
RECTANGLE FLAG CRESSI DIVE CENTER 150x90 cm	VABANDIVE01		-
BANNER FLAG CRESSI DIVE CENTER 350x60 cm	VABANDIVE02		-
WING FLAG CRESSI DIVE CENTER 60x240 cm	VABANDIVE03		-



Photo by: Stéphanie Dutin-Delannoy

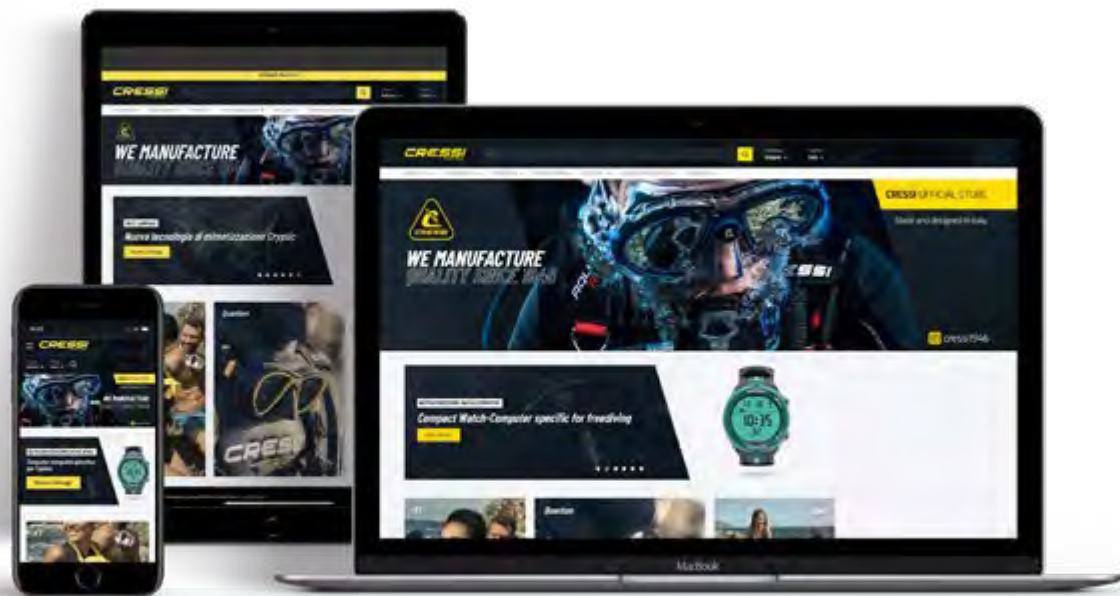
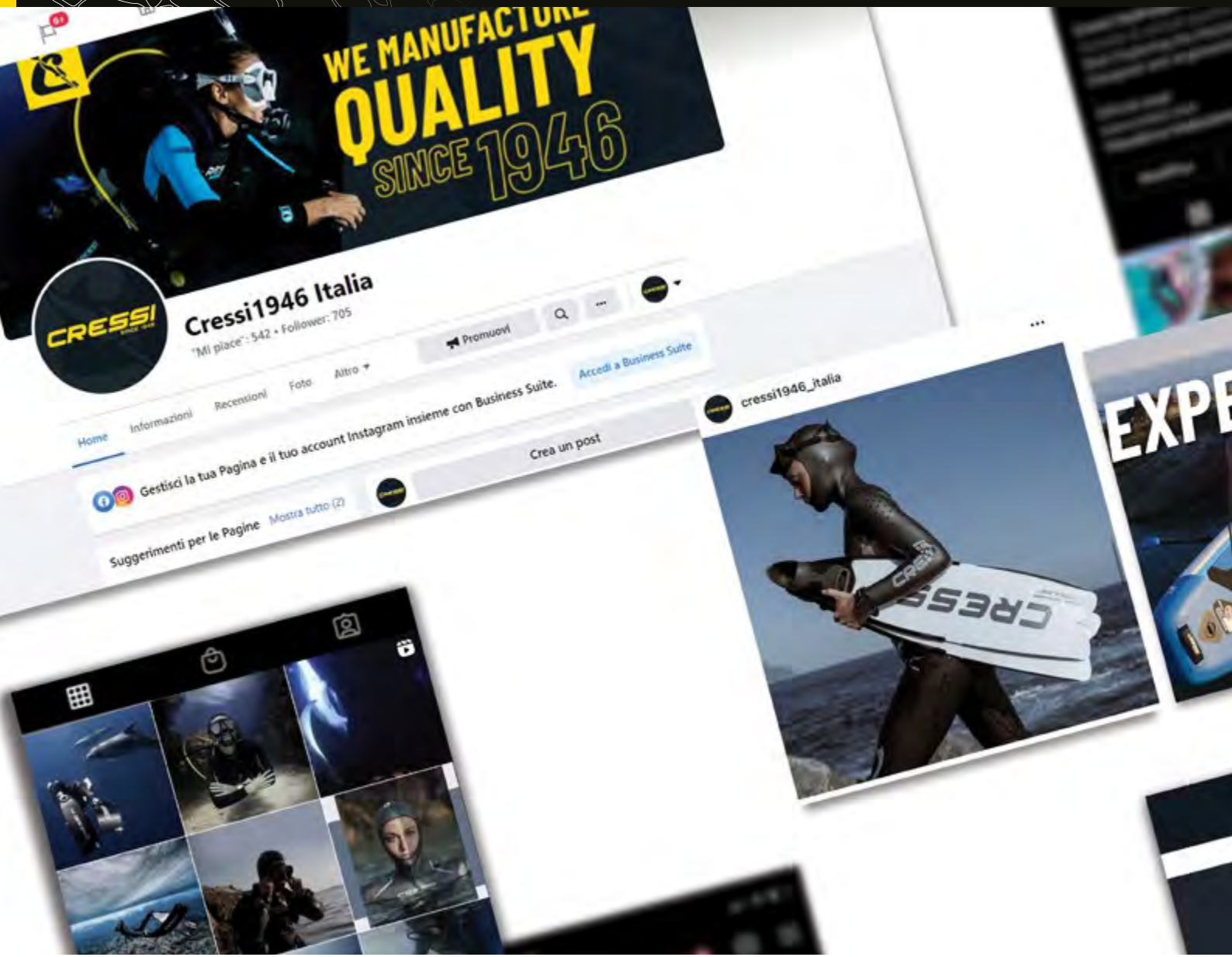

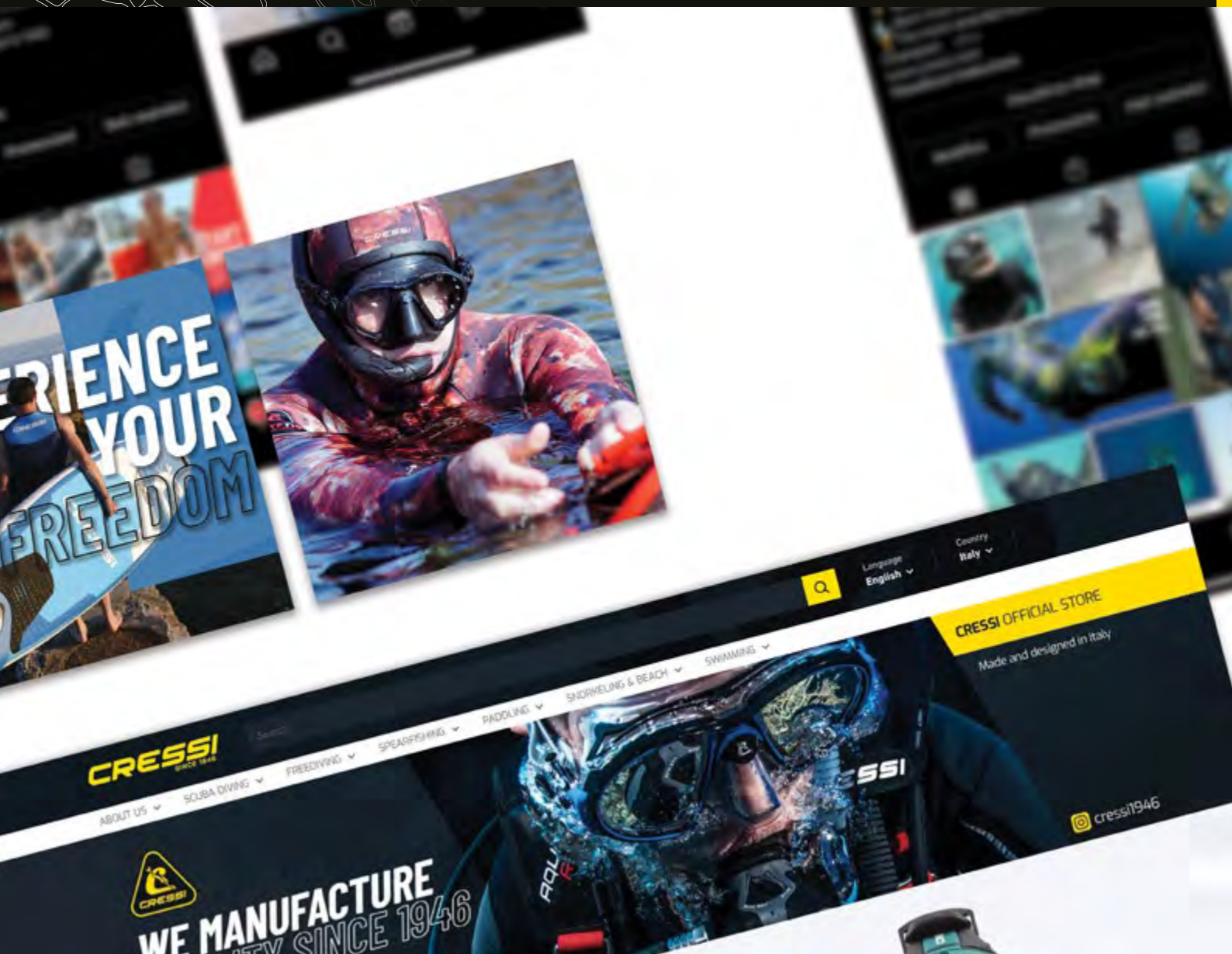

#SHARE YOUR EXPERIENCE

FOLLOW US



Official Website

www.cressi.com

Official Social Media

Facebook

Cressi
 Cressi1946.italia
 Cressi.spearfishing
 Cressi.hydroports

Instagram

Cressi 1946
 Cressi1946 Italia
 Cressi Spearfishing
 Cressi Hydroports

Youtube

Cressi

Twitter

Cressitaly

TikTok

Cressi 1946



FROM
GENOVA

WE MANUFACTURE QUALITY SINCE 1946



A project by Cressi Design Center
 Photo by Marcello Pastonesi, Studio Nicama, Cressi Ambassadors & Partners
 Front cover: Marcello Pastonesi

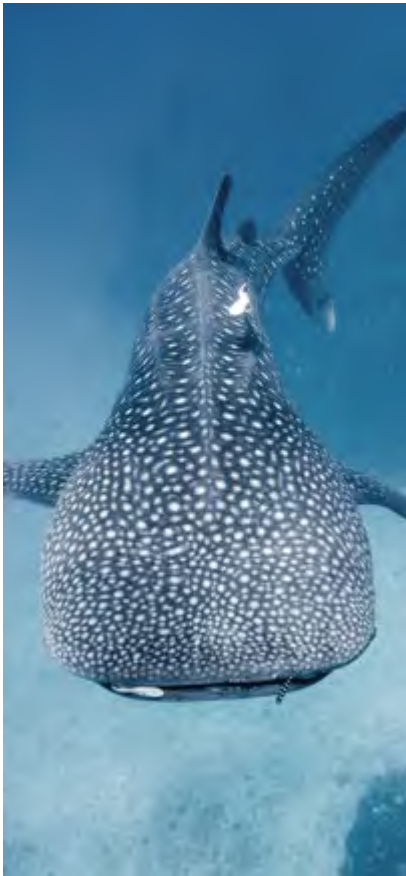

Cressi Sub S.p.A.
Headquarters:
 Via G. Adamoli, 501
 16165 Genova, Italy



© Cressi Sub S.p.A.. All rights reserved. Reproduction, scanning, transmittal or storage, by any means, of the images in this catalog, whole or in part, is prohibited without the prior written permission of Cressi Sub S.p.A.



www.store.cressi.com

EAN
 8 022983 273839 >
CRESSI
 BUYER'S GUIDE CATALOGUE EN RRP
 2025

SKU: VPCABGRRP25 SREF: 605685
 MADE IN EUROPEAN UNION / ITALY

UPC
 1 94482 08467 9